



INSTRUCTION MANUAL

MULTIBAND FM TRANSCEIVER IC-T90A

This device complies with Part 15 of the FCC Rules. Operation is subject to the following two conditions: (1) This device may not cause harmful interference, and (2) this device must accept any interference received, including interference that may cause undesired operation.

WARNING: MODIFICATION OF THIS DEVICE TO RECEIVE CELLULAR RADIO TELEPHONE SERVICE SIGNALS IS PROHIBITED UNDER FCC RULES AND FEDERAL LAW.

Icom Inc.



FOREWORD

Thank you for purchasing this Icom product. The IC-T90A MULTIBAND TRANSCEIVER is designed and built with Icom's superior technology and craftsmanship. With proper care, this product should provide you with years of trouble-free operation.

The IC-T90A is a tri-band, 50 MHz, 144 MHz, 430 (440) MHz FM transceiver that offers a wide-band AM, FM and WFM scanning receiver. Not only you can hear your favorite TV programs with the pre-programmed TV memories, but you can also listen to short wave, AM and FM broadcast radio stations, police, fire, military, aircraft, various amateur bands and more.

New DMS(Dynamic Memory Scan) bank scanning provides 555 alphanumeric memory channels, including 50 band edges, with a maximum of 18 banks or 100 channels per bank. You can pick and choose any desired channel for scanning from the 500 memories.

The supplied BP-217 LITHIUM-ION BATTERY PACK provides full 5 W output. Along with the energy conserving settings, the BP-217 provides up to 5 to 6 hours of operating time.

The supplied MB-83 swivel type belt clip performs a quick draw like action for attaching/detaching the transceiver from the belt clip.

And newly designed antenna also provides a stable signal strength.

We want to thank you for making your IC-T90A your radio of choice, and hope you agree with Icom's philosophy of "technology first." Many hours of research and development went into the design of your IC-T90A.

◆ **FEATURES**

- *Tri-band FM transceiver*
- *Wide-band receiver*
—Covers 495 KHz to 999.990 MHz
- *New DMS (Dynamic Memory Scan) bank scan*
- *Lithium-Ion technology*
- *Rugged palm sized, weather-resistant construction*
- *DTCS and CTCSS tone squelch*
- *Simple operation*

IMPORTANT

READ ALL INSTRUCTIONS carefully and completely before using the transceiver.

SAVE THIS INSTRUCTION MANUAL — This instruction manual contains important operating instructions for the IC-T90A.

EXPLICIT DEFINITIONS

The explicit definitions below apply to this instruction manual.

WORD	DEFINITION
WARNING	Personal injury, fire hazard or electric shock may occur.
CAUTION	Equipment damage may occur.
NOTE	If disregarded, inconvenience only. No risk of personal injury, fire or electric shock.

Icom, Icom Inc. and the ICOM logo are registered trademarks of Icom Incorporated (Japan) in the United States, the United Kingdom, Germany, France, Spain, Russia and/or other countries.

SUPPLIED ACCESSORIES

Accessories included with the transceiver: Qty.

- ① Li-Ion battery pack (BP-217) 1
- ② Wall charger* (BC-110AR/D/DR) 1
- ③ MB-83 swivel belt clip 1 set
- ④ Handstrap 1
- ⑤ Antenna (FA-S6270D; with 50 MHz band adapter) .. 1 set

* Not supplied with some versions.

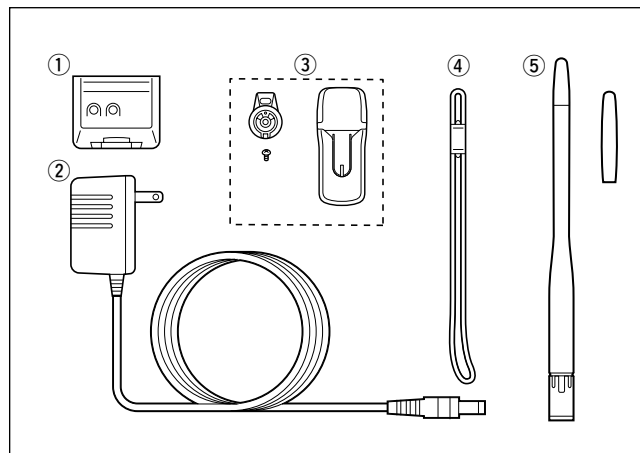

CAUTIONS

⚠ WARNING RF EXPOSURE! This device emits Radio Frequency (RF) energy. Extreme caution should be observed when operating this device. If you have any questions regarding RF exposure and safety standards please refer to the Federal Communications Commission Office of Engineering and Technology's report on Evaluating Compliance with FCC Guidelines for Human Radio Frequency Electromagnetic Fields (OET Bulletin 65)

⚠ WARNING! NEVER hold the transceiver so that the antenna is very close to, or touching exposed parts of the body, especially the face or eyes, while transmitting. The transceiver will perform best if the microphone is 1 to 2 in (2 to 5 cm) away from the lips and the transceiver is vertical.

⚠ WARNING! NEVER operate the transceiver with a headset or other audio accessories at high volume levels. Hearing experts advise against continuous high volume operation. If you experience a ringing in your ears, reduce the volume level or discontinue use.

⚠ NEVER CONNECT a power supply of more than 11.5 V DC to the DC jack. **The supply voltage must be between 5.5 V and 11.5 V** to prevent damaging the transceiver.

NEVER connect the transceiver to an AC outlet . Such a connection will damage the transceiver.

NEVER connect the transceiver to a power source that is

DC fused at more than 5 A. Accidental reverse connection will be protected by this fuse, but higher fuse values will not give proper protection against such accidents and the transceiver will be ruined.

DO NOT operate the transceiver near unshielded electrical blasting caps or in an explosive atmosphere.

AVOID using or placing the transceiver in direct sunlight or in areas with temperatures below +14°F (−10°C) or above +140°F (+60°C).

RF output power is automatically reduced to 0.5 W (Low) in cold environments (below 0°C) while operating with the BP-217 Li-Ion battery pack, to protect the battery pack. Keep the battery pack warm, then select high power again. (p. 28)

The use of non-Icom battery packs/chargers may impair transceiver performance and invalidate the warranty.

Even when the transceiver power is OFF, a slight current still flows in the circuits. Remove the battery pack or case from the transceiver when not using it for a long time. Otherwise, the battery pack or installed batteries will become exhausted.

For U.S.A. only

CAUTION: Changes or modifications to this device, not expressly approved by Icom Inc., could void your authority to operate this device under FCC regulations.

TABLE OF CONTENTS

FOREWORD	i	■ Split operation	32	■ Clearing a DTMF memory	69
IMPORTANT	ii	■ Auto repeater function	33	■ Confirming a DTMF memory	69
EXPLICIT DEFINITIONS	ii	■ 1750 Hz tone	34	■ Tone frequency and DTCS code	70
SUPPLIED ACCESSORIES	ii	5 MEMORY/CALL CHANNELS 35–44		■ Tone/DTCS squelch	71
CAUTIONS	iii	■ General	35	■ Pocket beep function	71
TABLE OF CONTENTS	iv	■ Calling up memory channels	36	■ Available tone frequencies	72
1 QUICK REFERENCE GUIDE	1–6	■ Programming memory channels	37	■ Available DTCS codes	72
2 PANEL DESCRIPTION	7–12	■ Transferring memory contents to VFO	38	■ Tone scan	73
■ Panel description	7	■ Copying memory contents	39	■ Beep tones	74
■ Function display	11	■ Memory names	39	■ Dial speed acceleration	74
3 BATTERY CHARGING	13–16	■ Memory bank	41	■ Lock function	74
■ Battery attachment	13	■ Memory clear	43	■ Morse code synthesizer	75
■ Battery cautions	13	■ Call channel	44	■ Power save	75
■ Regular charging	14	6 SCAN OPERATION	45–49	■ Time-out timer	76
■ Rapid charging	15	■ Scan types	45	■ PTT lock	76
■ Battery case	16	■ VFO scan	46	■ Auto power OFF	76
■ External power operation	16	■ Frequency skip function	47	■ Auto power ON	76
4 BASIC OPERATION	17–34	■ Skip channel setting	47	■ Weather channel operation	77
■ Turning power ON	17	■ Memory scan	48	■ Cloning function	79
■ Tuning step	18	■ Scan notes	49	■ [SP/MIC] jacks	79
■ Setting a frequency	19	7 PRIORITY WATCH	50–54	■ Resetting	80
■ Mode selection	20	■ Priority watch types	50	10 HM-75A REMOTE CONTROL MICROPHONE	81
■ Operating band and receive mode selection	21	■ Priority alert	50	11 TROUBLESHOOTING	82
■ Setting the squelch level	22	■ Priority watch operation	51	12 TV FREQUENCY TABLE	83–86
■ Receiving	23	8 SET MODE	55–66	13 SPECIFICATIONS	87–88
■ RIT function	27	■ Set mode	55	14 OPTIONS	89–90
■ Attenuator function	27	■ Set mode items	56	POCKET GUIDE	
■ Transmitting	28	9 OTHER FUNCTIONS	67–80		
■ Repeater operation	29	■ Programming a DTMF code	67		
■ Duplex operation	31	■ Transmitting a DTMF code	68		

1

2

3

4

5

6

7

8

9

10

11

12

13

14

QUICK REFERENCE GUIDE

■ Installing the battery pack

- ① Open the latch. Then, attach the BP-217 Li-Ion battery pack or BP-216 optional battery case.
 - Be sure to observe the correct direction.
 - Charge Li-Ion battery pack before use.
- ② Lock the latch.

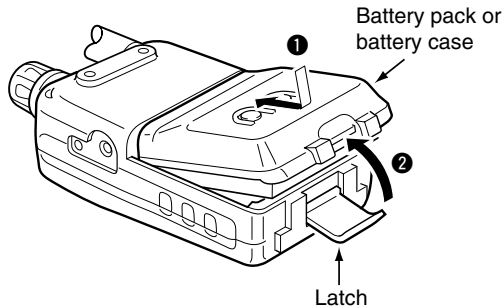

NOTE: The battery pack is provided uncharged. **BE SURE** to charge the battery before using it with the transceiver.

◇ Installing the alkaline batteries

- Install 2 R6 (AA) size alkaline batteries into BP-216.
- Be sure to observe the correct polarity.

Keep battery contacts clean. It's a good idea to clean battery terminals once a week.

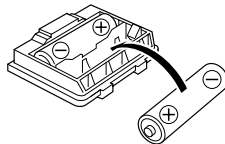

■ Accessory attachment

◇ Attaching the swivel belt clip

The supplied swivel belt clip is useful for easy attaching/detaching the transceiver to/from the belt.

- ① Attach the stopper to the transceiver with the supplied screw.

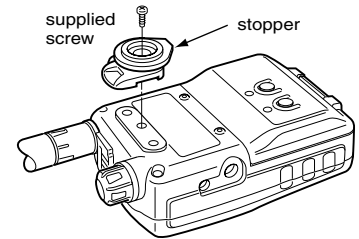

- ② Clip the belt clip to your belt.

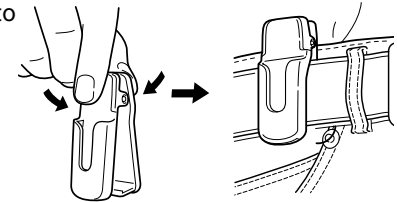

- ③ Insert the transceiver into the end of the clip as shown at right.

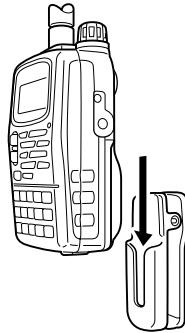

- Once the transceiver is locked in place, it will swivel 360 degrees as shown at right.

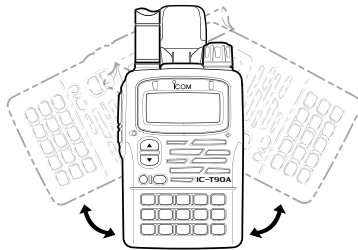

CAUTION!

HOLD THE TRANSCEIVER TIGHTLY, WHEN ATTACHING OR REMOVING THE TRANSCEIVER TO/FROM THE BELT CLIP.

If the transceiver accidentally dropped and the swivel belt clip's stopper is scratched, the swivel belt clip may not work properly.

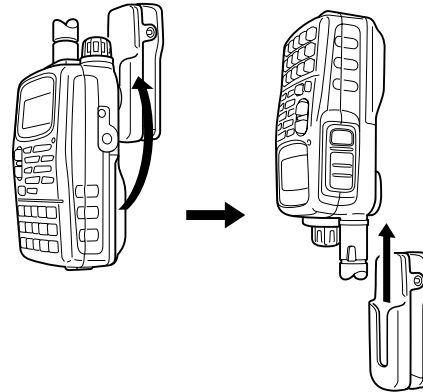

◇ Handstrap

Slide the handstrap through the loop on the top of the belt clip as shown at right.



To remove:

- ④ Turn the transceiver upside down, and then lift to release the transceiver from the belt clip as shown at upper right.

1 QUICK REFERENCE GUIDE

◇ Attaching the antenna

Insert the supplied wide band antenna into the antenna connector and screw down the antenna as shown below.

•50 MHz band adapter

Attach the 50 MHz band antenna adapter before operating on or receiving the signal below the 50 MHz band. Be sure to use this 50 MHz band adapter during operation below the 50 MHz band. You can operate on the whole band with this adapter.

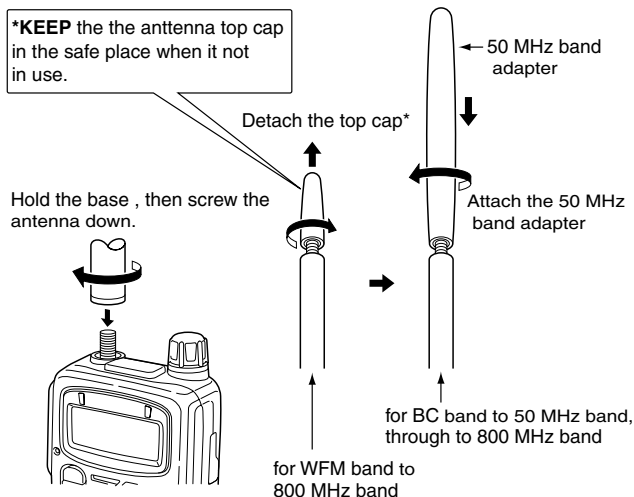

⚠ CAUTION!

TRANSMITTING WITHOUT AN ANTENNA MAY DAMAGE THE TRANSCEIVER.

NEVER HOLD the antenna when carrying the transceiver.

KEEP the jack covers attached when the jack is not in use, to avoid bad contacts from dust and moisture.



NOTE:

Commercially available antennas may increase transceiver performance. An optional AD-92SMA ANTENNA CONNECTOR ADAPTER is available to connect an external antenna with a BNC connector.

■ Charging the Li-Ion battery pack

◇ Charging with the wall charger

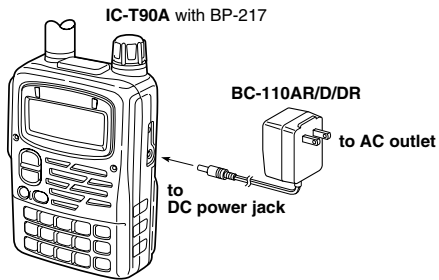

- ① Push and hold [PWR] to turn the transceiver power OFF.
- ② Insert the charger plug into the DC power jack of the transceiver.
- ③ Plug the charger into an AC wall outlet.
- ④ Charging starts and the battery indicator “■” on the display blinks.
- ⑤ It takes approximately 15 hours to charge an empty BP-217 Li-Ion battery pack.
- ⑥ Unplug the charger from the AC wall outlet when charging is completed.

◇ Charging with the CP-19 Cigarette Lighter cable (optional)

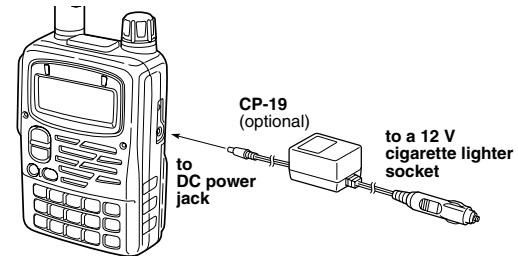

- ① Insert the cigarette lighter adapter cable into the DC power jack of the transceiver.
- ② Connect the CP-19 cigarette lighter adapter cable to the cigarette lighter socket.
- ③ Charging starts and the battery indicator on the display blinks.

NOTE:

- The BP-217 can be charged while you are operating the transceiver. (p. 5).
- Charging will be suspended during transmitting of the transceiver.
- “CHG_F” appears when the charging is completed with the power turned OFF.
- **NEVER** connect the cigarette lighter socket or external regulated DC power supply directly to the transceiver. Such a connection will damage the transceiver.
- Remove CP-19 from the transceiver when not using it. Otherwise, the vehicle battery will become exhausted.

1 QUICK REFERENCE GUIDE

■ Rapid charging

The optional BC-139 provides rapid charging of the battery pack.

CAUTION: To avoid damage to the transceiver, turn the transceiver OFF while charging.

• **Charging period:** 2.5 hours (w/BP-217)

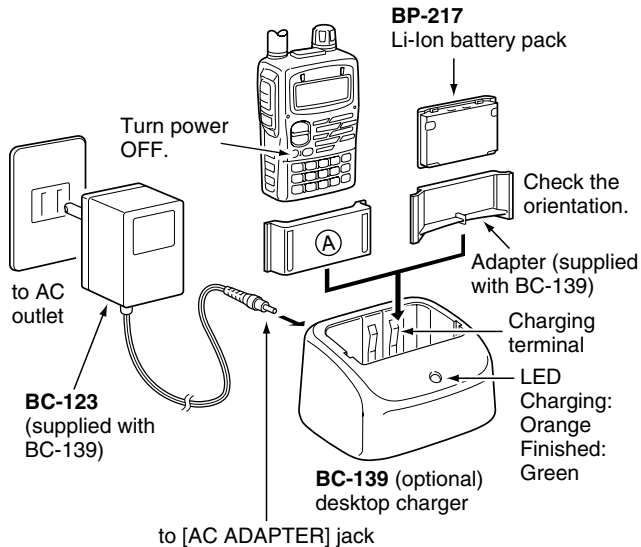

■ External power operation

An optional CP-19 cigarette lighter cable can be used for external power operation from a 12 V DC cigarette lighter socket.

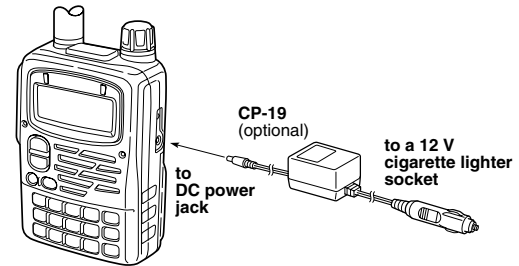

- Power supply range is between **5.5–11.5 V DC**. **NEVER CONNECT OVER 11.5 V DC** directly into the DC power jack of the transceiver.
- **BE SURE** to use the **CP-19** when connecting a regulated 12 V DC power supply.
- If a battery pack is attached, the voltage of the external power supply must be within 11.5–16 V DC, otherwise, the battery power may be used for operation.
- The maximum output power is 5.0 W regardless of the power supply voltage.
- Remove the cables from the transceiver when not using it. Otherwise, the vehicle battery will become exhausted.

■ Your first contact

Now that you have your IC-T90A ready to operate, you are probably excited to get on the air. We would like to take you through a few basic operation steps to make your first “On The Air” an enjoyable experience.

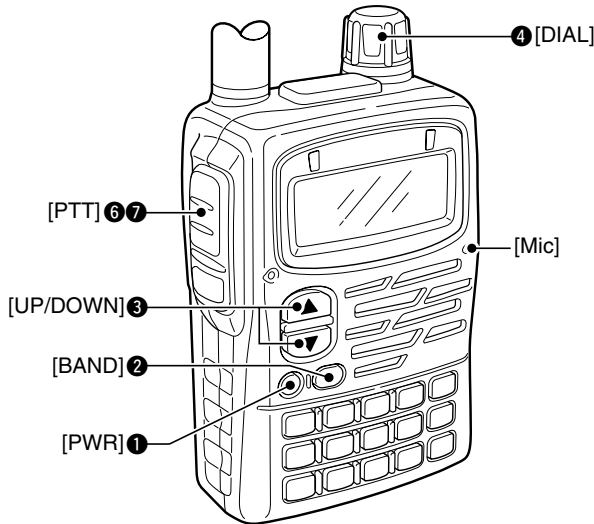

◇ First contact

- ① Push and hold [PWR] for 1 sec. to turn the transceiver power ON.
 - The function display shows “ICOM,” current voltage then the operating frequency.
- ② Push [BAND] several times until the desired operating band (VHF; 51.000, 146.010 or UHF; 440.000 as default) appears on the display.
- ③ Push [▲](or [▼]) several times to adjust to the desired audio level.
- ④ Rotate [DIAL] to select the receive frequency.

[EXAMPLE] Setting the receive frequency to 444.350 MHz

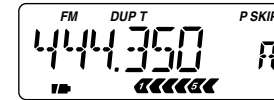

‘Direct frequency input’ via the keypad also available. (p. 19)

- ⑤ Hold the transceiver approximately 2 in. (5 cm) from your mouth.
- ⑥ Push and hold [PTT], then speak at your normal voice level.
- ⑦ Release [PTT] switch to receive.

• Repeat steps, ⑤, ⑥ and ⑦ to continue communication.

■ Panel description

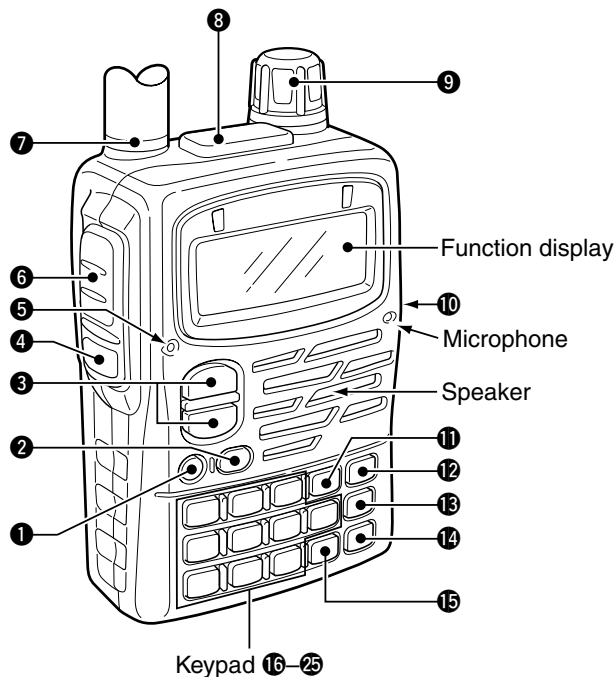

❶ POWER SWITCH [PWR]

Push for 1 sec. to turn the transceiver power ON and OFF.

❷ BAND SWITCH [BAND]

➤ Push to select the operating band (5 MHz, Air, VHF, UHF, etc.). (p. 21)

➤ Push to select the memory bank or push to proceed the memory name cursor while programming the memory option. (pgs. 39, 41)

➤ Push for 1 sec. for morse code synthesizer announcement. (p. 75)

➤ While pushing [PTT], this key sends a DTMF "D."

❸ UP/DOWN SWITCHES [▲]/[▼]

➤ Push to adjust the audio level by default. (p. 17)

➤ Push to adjust the frequency when [▲]/[▼] and [DIAL] are exchanged by pushing [1 V↔D] for 1 sec. (p. 23)

❹ MONITOR SWITCH [SQL] (p. 22)

➤ Push and hold to temporarily open the squelch and monitor the operating frequency.

➤ While pushing, rotate the tuning dial to set the squelch threshold level.

❺ TRANSMIT/RECEIVE INDICATOR

➤ Lights green while receiving a signal or when the squelch is open; lights red while transmitting.

➤ Blinks green for 5 sec. when the scan stop LED function is in use and a scan is stopped. (pgs. 46, 62)

6 PTT SWITCH [PTT]

- ➔ Push and hold to transmit in 50/144/430 (440) MHz amateur bands; release to receive. (p. 28)
 - When WFM or AM mode is selected, transmission is impossible.

7 ANTENNA CONNECTOR (p. 3)

Connects the supplied antenna.

8 EXTERNAL SPEAKER AND MICROPHONE JACKS [SP/MIC]

Connects an optional speaker-microphone or headset, if desired. The internal microphone and speaker will not function when any external equipment is connected. (See pgs. 89, 90 for a list of available options.)

9 TUNING DIAL [DIAL]

- ➔ Rotate [DIAL] to set operating frequencies, memory channels, set mode contents, etc. (pgs. 19, 36, 55)
- ➔ While pushing [SQL], sets the squelch level. (p. 22)
- ➔ While pushing [BAND], sets the operating band in VFO mode. (p. 21)
- ➔ While pushing [▲]/[▼], adjusts the audio level (when [▲]/[▼] and [DIAL] are not exchanged). (p. 17)

10 EXTERNAL DC POWER JACK [DC 11.0 V]

- ➔ Allows charging of the BP-217 using the BC-110A/D wall charger, or using an optional CP-19 cigarette lighter cable.
- ➔ To connect regulated power supply with optional CP-19

cigarette lighter cable.

11 MODE/SCAN SWITCH [MODE SCAN]



- ➔ Push to select the operating mode (FM, WFM, AM). (p. 21)
- ➔ Push for 1 sec. to start a scan. (p. 45)
- ➔ While pushing [PTT], this key sends the DTMF code “F” (#).

12 VFO SWITCH [VFO MHz]



- ➔ Selects and toggles between VFO A and B. (p. 20)
- ➔ Selects and toggles between the 1 MHz or 10 MHz tuning steps when pushed for 1 sec. (p. 18)
- ➔ Returns to previous operating condition while setting frequency or memory channel, or while in set mode.
- ➔ While pushing [PTT], this key sends the DTMF code “A”.

13 MEMORY SWITCH [MR S.MW]



- ➔ Selects and toggles between memory mode and memory bank. (p. 20)
- ➔ Push for 1 sec. to enter memory write condition. (p. 37)
- ➔ Push for 2 sec. to write the operating frequency into the selected memory channel in VFO mode.
 - Keep pushing for 2 sec. or more to automatically select the next memory channel, if desired. (p. 38)
- ➔ Push [MR S.MW] for 2 sec. to transfer the displayed frequency into the VFO in memory mode. (p. 38)

2 PANEL DESCRIPTION

➔ While pushing [PTT], this key sends a DTMF “B”.

14 CALL/LOCK SWITCH [CALL/TV LOCK]



➔ Toggles between call channel, TV channel, weather channel (U.S.A. version only) and VFO mode in sequence. (p. 20)

➔ Push for 1 sec. to toggle the lock function ON and OFF. (p. 74)

• “” appears while the key lock function is in use.

➔ While pushing [PTT], this key sends the DTMF code “C”.

15 DTMF MEMORY SWITCH [• DTMF.M]



➔ Push for 1 sec. to enter the DTMF memory channel. (p. 67)

➔ Inputs MHz digit for frequency input. (p. 19)

➔ While pushing [PTT], this key sends the DTMF code “E” (*).

16 VOLUME/DIAL SWITCH [1 V↔D]



➔ Push for 1 sec. to exchange [▲]/[▼] and [DIAL] functions. (p. 23)

• “VOL” appears when the tuning dial functions as a volume control.

➔ Inputs digit ‘1’ for frequency input, memory channel selection, etc.

➔ While pushing [PTT], this key sends the DTMF code “1”.

17 TONE SWITCH [2 TONE] (p. 70)



➔ Push for 1 sec. to activate the following tone functions in order.

• Subaudible tone encoder — “T” appears. (p. 29)

• Tone squelch — “T SQL” appears. (p. 71)

• Pocket beep — “T SQL (•)” appears. (p. 71)

• DTCS squelch — “DTCS” appears. (p. 71)

• DTCS beep — “(•) DTCS” appears. (p. 71)

• No tone operation — no tone indicator appears.

➔ Inputs digit ‘2’ for frequency input, memory channel selection, etc.

➔ While pushing [PTT], this key sends the DTMF code “2”.

18 OUTPUT POWER SWITCH [3 H/L] (p. 28)



➔ Push for 1 sec. to toggle output power between high and low.

• “LOW” appears when low output power is selected.

➔ Inputs digit ‘3’ for frequency input, memory channel selection, etc.

➔ While pushing [PTT], this key sends the DTMF code “3”.

19 DUPLEX SWITCH [4 DUP] (pgs. 29, 31)



➔ Push for 1 sec. to activate the following duplex functions in order.

• Minus duplex operation — “-DUP” appears.

• Plus duplex operation — “DUP” appears.

• Simplex operation — no duplex indicator appears.

➔ Inputs digit ‘4’ for frequency input, memory channel selection, etc.

➔ While pushing [PTT], this key sends the DTMF code “4”.

20 FREQUENCY SKIP SWITCH [5 SKIP]



- ➔ Push for 1 sec. to turn the frequency skip function ON and OFF in VFO mode. (p. 47)
 - “P SKIP” appears when the frequency skip function is in use.
- ➔ Push for 1 sec. to set the memory channel as the following skip channel in memory mode in order. (p. 48)
 - Skip channel — “SKIP” appears.
 - Frequency skip channel — “P SKIP” appears.
 - Non-skip channel — no skip indicator appears.
- ➔ Push for 1 sec. to program a paused frequency as a skip frequency while scanning. (p. 48)
- ➔ Inputs digit ‘5’ for frequency input, memory channel selection, etc.
- ➔ While pushing [PTT], this key sends the DTMF code “5”.

21 MEMORY NAME SWITCH [6 M.N.]



- ➔ Push for 1 sec. to turn the memory name indication ON and OFF. (p. 39)
 - Frequency appears for nameless memory channels.
- ➔ Inputs digit ‘6’ for frequency input, memory channel selection, etc.
- ➔ While pushing [PTT], this key sends the DTMF code “6”.

22 TONE SCAN SWITCH [7 T.SCAN]



- ➔ Push for 1 sec. to start a tone scan. (p. 73)
- ➔ Inputs digit ‘7’ for frequency input, memory channel selection, etc.

- ➔ While pushing [PTT], this key sends the DTMF code “7”.

23 SET MODE SWITCH [8 SET]



- ➔ Push for 1 sec. to enter the set mode. Push to select the displayed set mode item after selecting with [DIAL] while in the set mode. (p. 55)
- ➔ Inputs digit ‘8’ for frequency input, memory channel selection, etc.
- ➔ While pushing [PTT], this key sends the DTMF code “8”.

24 TUNING STEP SWITCH [9 TS]



- ➔ Push for 1 sec. to select the tuning step. (p. 18)
- ➔ Inputs digit ‘9’ for frequency input, memory channel selection, etc.
- ➔ While pushing [PTT], this key sends the DTMF code “9”.

25 RIT/ATTENUATOR SWITCH [0 RIT]



- ➔ Push for 1 sec. to enter the RIT/attenuator set mode. Push to select the item after selecting with [DIAL]. (p. 27)
 - RIT function is available for 630.000 MHz and above.
 - Attenuator for 629.995 MHz or less only.
- ➔ Inputs digit ‘0’ for frequency input, memory channel selection, etc.
- ➔ While pushing [PTT], this key sends the DTMF code “0”.

■ Function display

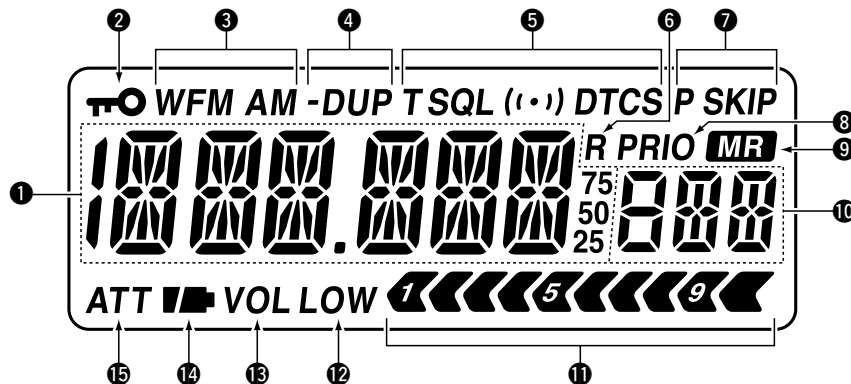

❶ FREQUENCY READOUT

Shows the operating frequency, set mode contents, etc.

- The smaller “75,” “50” and “25” to the right of the readout indicate 0.75, 0.5 and 0.25 kHz, respectively.
- The decimal point of the frequency blinks during scan.

❷ LOCK INDICATOR (p. 74)

Indicates that the lock function is in use.

❸ RECEIVE MODE INDICATORS (p. 21)

Shows the receive mode.

- AM, FM and WFM are available.

❹ DUPLEX INDICATORS (pgs. 29, 31)

Appears when semi-duplex operation (repeater operation) is in use.

- “-DUP” appears when minus duplex is selected; “DUP” only, appears when plus duplex is selected.

5 TONE INDICATORS (p. 70)

- ➔ Appears when the following tone functions are activated.
 - Subaudible tone encoder — “T” appears. (p. 29)
 - Tone squelch — “T SQL” appears. (p. 71)
 - Pocket beep — “T SQL ((·))” appears. (p. 71)
 - DTCS squelch — “DTCS” appears. (p. 71)
 - DTCS beep — “((·)) DTCS” appears. (p. 71)
- ➔ “((·))” blinks when the correct tone or code is received during pocket/DTCS beep operation. (p. 71)

6 RIT INDICATOR (p. 27)

Appears when the RIT (Receive Incremental Tuning) function for 630.000 MHz and above is in use.

7 SKIP SCAN INDICATOR (p. 47)

- ➔ “SKIP” appears when a selected memory channel is set as a skip channel.
- ➔ “P SKIP” appears when the memory channel frequency is set as a skip frequency in memory mode.
- ➔ “P SKIP” appears when the frequency skip function is turned ON in VFO mode.

8 PRIORITY WATCH INDICATOR (p. 50)

Appears when priority watch is in use.

9 MEMORY MODE INDICATOR (p. 20)

Appears when a memory channel is selected.

10 MEMORY CHANNEL NUMBER READOUT (p. 20)

Shows the memory or call channel number, etc.

11 S/R/F INDICATORS (p. 28)

Shows the relative signal strength while receiving. Shows the relative output power while transmitting.

12 LOW POWER INDICATOR (p. 28)

Appears when low output power is selected.

13 VOLUME EXCHANGE INDICATOR (p. 23)

Appears when the functions of tuning dial and [▲]/[▼] switches are exchanged.

14 BATTERY INDICATORS

- ➔ Both segments appear when the batteries have ample capacity.
 - They do not appear when operating with an external power source.
- ➔ Only the right segment “■” appears when the batteries are nearing exhaustion.
- ➔ Blinks while charging the attached Li-Ion battery pack.

15 ATTENUATOR INDICATOR (p. 27)

Appears when the attenuator is in use.

3

BATTERY CHARGING

■ Battery attachment

- ① Attach the Li-Ion battery pack (BP-217) or battery case (BP-216).
 - Be sure to observe the correct direction.
 - Charge Li-Ion battery pack before use.
- ② Lock the latch.

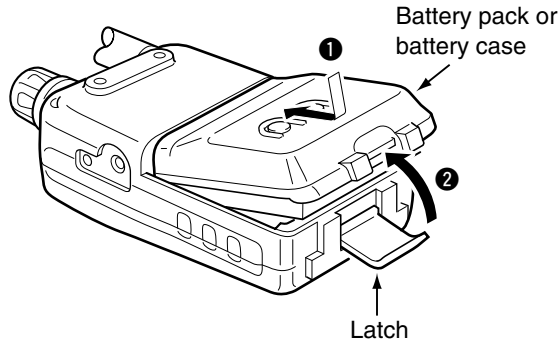

◇ Operating periods

The operating periods with BP-217 are:

- | | |
|---------|---------------|
| 50 MHz | Approx. 6 hr. |
| 144 MHz | Approx. 5 hr. |
| 440 MHz | Approx. 5 hr. |

at high power, Tx : Rx : Standby = 1:1:8

■ Battery cautions

NEVER incinerate used battery packs. Internal battery gas may cause an explosion.

NEVER immerse the battery pack in water. If the battery pack becomes wet, be sure to wipe it dry **BEFORE** attaching it to the transceiver.

NEVER short terminals of the battery pack. Also, current may flow into nearby metal objects so be careful when placing battery packs in handbags, etc.

If your battery pack seems to have no capacity even after being charged, completely discharge it by leaving the power ON overnight. Then, fully charge the battery pack again. If the battery pack still does not retain a charge (or very little), a new battery pack must be purchased.

Use Icom battery packs, chargers and cables only. The use of non-Icom products may impair transceiver performance and invalidate the warranty.

Even when the transceiver power is OFF, a slight current still flows in the circuits. Remove the battery pack or case from the transceiver when not using it for a long time. Otherwise, the battery pack or installed batteries will become exhausted.

■ Regular charging

Prior to using the transceiver for the first time, the battery pack must be fully charged for optimum life and operation.

CAUTION: To avoid damage to the transceiver, turn the transceiver OFF while charging.

- Recommended temperature range for charging: +32°F to +95°F; 0°C to +35°C
- Use the wall charger* (BC-110AR/D/DR) only. **NEVER** use another manufacturers' charger.
* Not supplied with some versions.
- An optional cable CP-19 (for 12 V cigarette lighter socket) can be used instead of the AC adapters of the above chargers.

◇ Battery indicators

The battery indicators blink while charging but do not indicate the power condition.

“CHG_F” appears when the charging is completed. Disconnect the wall charger in this case.

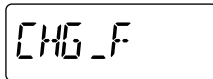

- ① Attach the battery pack to the transceiver.
- ② Be sure to turn the transceiver power OFF.
- ③ Connect the AC adapter* (BC-110AR/D/DR) as shown below.
* Not supplied with some versions.
- ④ Remove any cables from the [DC11V] jack.

• **Charging period:** 15 hours (w/BP-217)

IC-T90A with BP-217

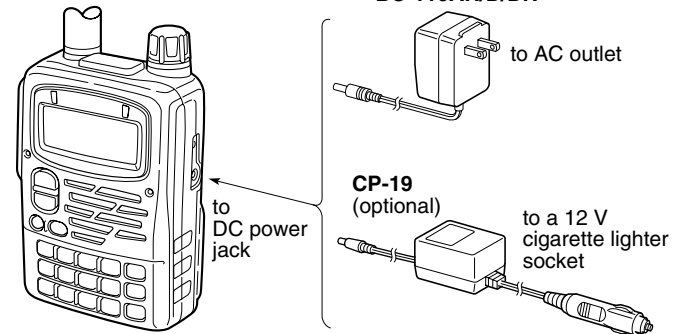

3 BATTERY CHARGING

■ Rapid charging

The optional BC-139 provides rapid charging of the battery pack.

• **Charging period:** 2.5 hours (w/BP-217)

/// **CAUTION:** To avoid damage to the transceiver, turn it OFF while charging.

- Recommended temperature range for charging:
+32°F to +95°F; 0°C to +35°C
- **NEVER** connect 2 chargers to the [AC ADAPTER] and [DC13.5V] jacks of the BC-139.
- Use the supplied BC-123 for the BC-139 desktop charger. Connect BC-123 to the [AC ADAPTER] jack.
- **NEVER** use another manufactures' charger.
- An optional cable CP-19 (for 12 V cigarette lighter socket) can be used instead of the supplied AC adapter. Connect one of these to the [DC11V] jack in this case.

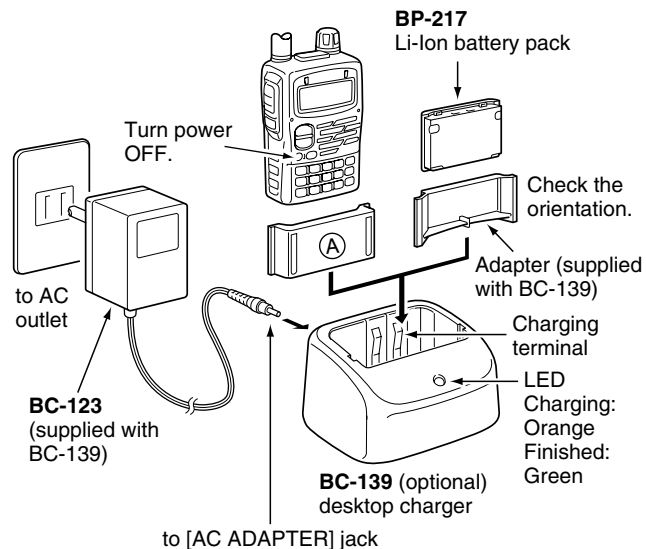

/// If the charge indicator blinks orange, there may be a problem with the battery pack (or charger). Re-insert the battery pack or contact your dealer.

■ Battery case (Option)

- ① Install 2 R6 (AA) size alkaline batteries into the optional BP-216 BATTERY CASE.
 - Be sure to observe the correct polarity.
- ② Install the battery case as shown at right.

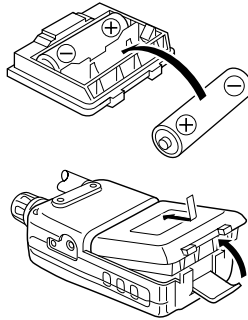

▨ A built-in step-up converter in the BP-216 increases the voltage up to 5 V DC.

▨ Keep battery contacts clean. It's a good idea to clean battery terminals once a week.

Voltage indication



◇ Battery information

The batteries may seem to have low capacity when used in low temperatures such as +14 °F (-10 °C) or below. Please keep the battery case or pack warm in this case.

◇ Battery replacement

When the batteries become exhausted, the function display may blink or have a lower contrast. In these cases, replace all batteries with new, same brand, alkaline batteries.

■ External power operation

An optional cable CP-19 (for 12 V cigarette lighter socket) can be used for external power operation.

- ▨ • Power supply range is between **5.5–11.0 V DC**. **NEVER CONNECT OVER 11.5 V DC** directly into the DC power jack of the transceiver.
- ▨ • **BE SURE** to use **CP-19** when connecting regulated 12 V DC power supply.
- ▨ • If a battery pack is attached, the voltage of the external power must be within 11.5–16 V DC, otherwise, the battery power may be used for operation.
- ▨ • The maximum output power is 5.0 W regardless of the power supply voltage.
- ▨ • Remove the cables from the transceiver when not using it. Otherwise, the vehicle battery will become exhausted.

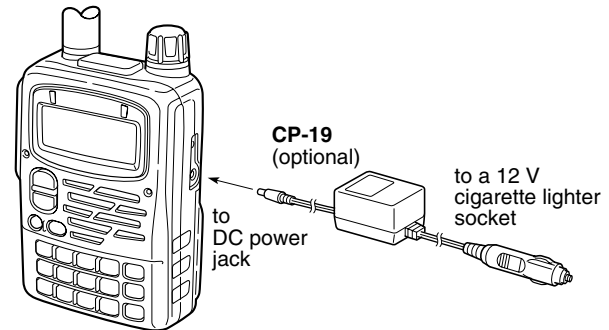

■ Turning power ON

◇ Turning power ON

- ① Make sure alkaline batteries are installed in the battery case or the battery pack is charged, and attach them. (p. 13)
- ② Push [PWR] for 1 sec. to turn the power ON.
 - The function display shows "ICOM," current voltage then the operating frequency.
 - Repeat this step to turn power OFF.

▨ The opening message can be turned ON or OFF in the expanded set mode 1. (p. 64)

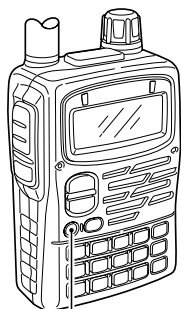

[PWR]

Opening message 'ICOM'

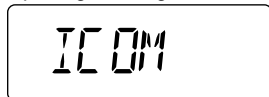

Voltage indication

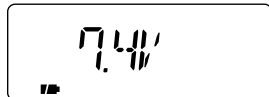

Frequency indication

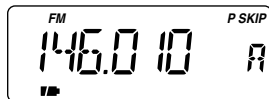

◇ Setting volume level

The audio level can be adjusted through 32 levels.

➡ Push [▲] or [▼] to set the desired audio level.

- Rotating the tuning dial while pushing [▲] or [▼] also sets the audio level.
- [▲]/[▼] and [DIAL] can be exchanged by [1 V↔D]. (p. 23)

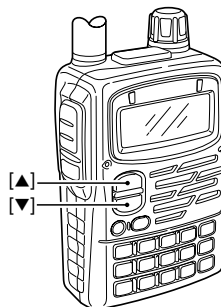

Shows volume level.



◇ Volume level indication

The frequency display shows the volume level during setting as shown below.

Indication	Audio level
-----	0 (no sound)
0 _ _ _ _	1-11
00 _ _ _	12-18
000 _ _	19-23 (default)
0000 _	24-27
00000	28-30
000000	31 (Maximum)

■ Tuning step

When using the tuning dial to change the frequency, or when a scan function is activated, the frequency changes in increments determined by the set tuning step. Tuning steps can be selected for each band. This transceiver has 13 tuning steps as follows:

- 5 kHz •6.25 kHz •8.33 kHz
- 9 kHz •10 kHz •12.5 kHz
- 15 kHz •20 kHz •25 kHz
- 30 kHz •50 kHz •100 kHz
- 200 kHz

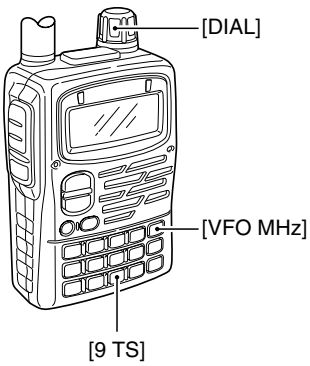

◇ Setting the tuning step

- ① Push [9 TS] for 1 sec. to enter tuning step set mode.
 - “TS” appears.
- ② Rotate [DIAL] to select the desired tuning step.
 - Rotating the tuning dial while pushing [9 TS] also selects the tuning step.
 - Tuning step can be set in VFO and memory modes.
- ③ Push [9 TS] or [VFO] to exit.

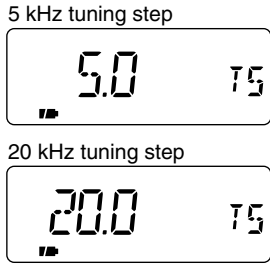

◇ MHz tuning step

This is useful to change the frequency rapidly.

- ① Select VFO mode with [VFO].
- ② Push [VFO MHz] for 1 sec. to select 1 MHz tuning step.
- ③ Push [VFO MHz] for 1 sec. again to select 10 MHz tuning step, if required.
- ④ Rotate [DIAL] to select the desired MHz frequency.
- ⑤ Push [VFO] to exit MHz tuning step.

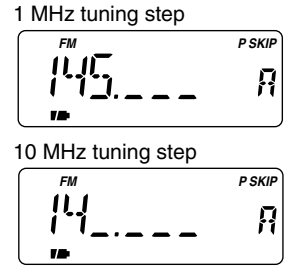

4 BASIC OPERATION

■ Setting a frequency

Push numeral keys and [•] to input the desired frequency.

- Frequency can be set irrelevant of the selected band.
- When inputting a frequency outside of the frequency range, the previously selected frequency is automatically selected after inputting 1 kHz digit.

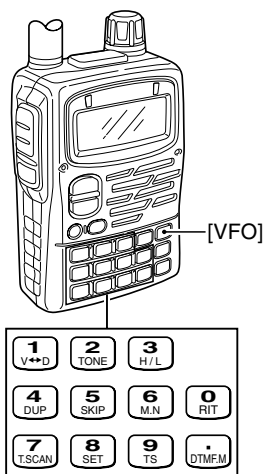

◇ Setting the frequency with keypad

- ① Select VFO mode with [VFO].
- ② Push the desired numeral buttons until inputting 1 kHz digit to set the frequency.
 - When you want to change the 100 kHz digit and below, push [•] first, then the numeral buttons.
 - Acceptable digits for the 1 kHz digit depend on the 10 kHz digit.

• Setting to 0.684 MHz

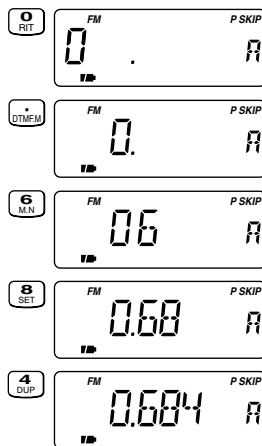

• Setting to 433.580 MHz

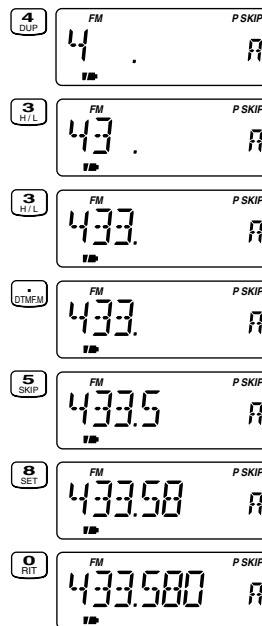

• Changing 100 kHz and below.

Setting 433.580 MHz to 433.240 MHz.

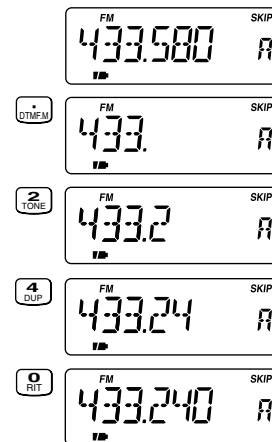

Mode selection

◇ VFO mode

VFO mode is used for setting a desired frequency within the band range.

- ➔ Push [VFO] to select VFO mode.
 - Pushing [VFO] in VFO mode toggles VFO A and B.

What is VFO?

VFO is an abbreviation of Variable Frequency Oscillator. Frequencies for transmitting and receiving are generated and controlled by the VFO.

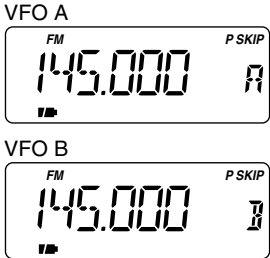
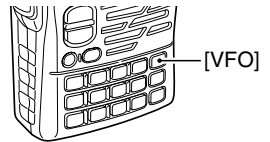

◇ Memory mode

Memory mode is used for operation of memory channels which have programmed frequencies.

- ➔ Push [MR] to select memory mode.
 - Pushing [MR] in memory mode toggles memory channel and memory bank indications.
 - To program a memory Ch, refer to p. 37.

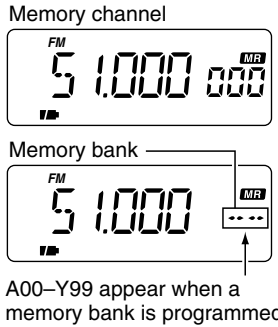
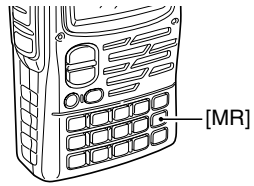

◇ Call/TV/weather channels

Call channels are used for most-often-used frequencies for quick recall. TV and weather (U.S.A. version only) channels can be selected with [CALL/TV].

- ➔ Push [CALL/TV] to select a call, TV and weather channel in sequence.

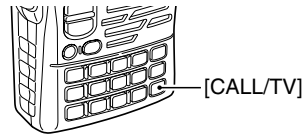

4 BASIC OPERATION

■ Operating band and receive mode selection

◇ Selecting the operating band

The transceiver can receive the BC (broadcast) bands, 5 MHz band, 50 MHz band, FM broadcast band, Air band, VHF (144 MHz) band, 220 MHz band, 300 MHz band, UHF (430MHz) band or 800 MHz band.

* Frequency coverage depends on versions.

- ① Select VFO mode with [VFO].
 - ② Push [BAND] several times to select the desired band.
- Rotating the tuning dial while pushing [BAND] also selects the operating band.

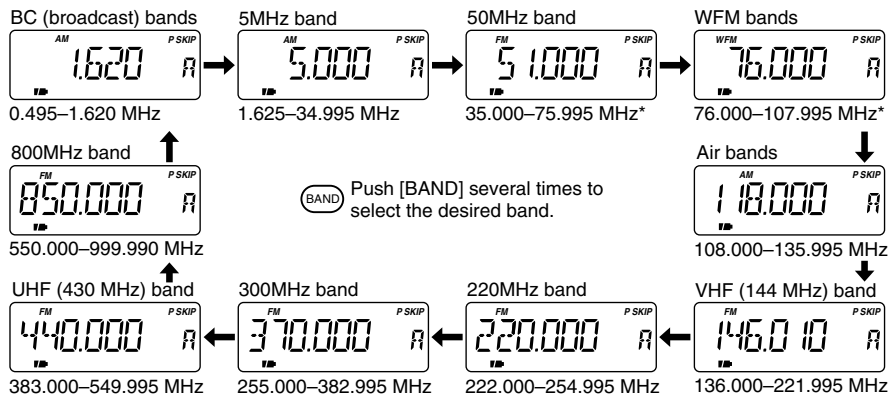
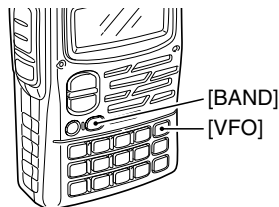

◇ Selecting the receive mode

Receive modes are determined by the physical properties of the radio signals. The transceiver has 3 receive modes: FM, AM and WFM modes. Typically, AM mode is used for the avionics band (108–135.995 MHz) and WFM is used for FM broadcast stations (76–107.995 MHz).

When pushing [PTT], a beep tone sounds indicating the mode is not FM mode. The transceiver cannot transmit in AM or WFM mode.

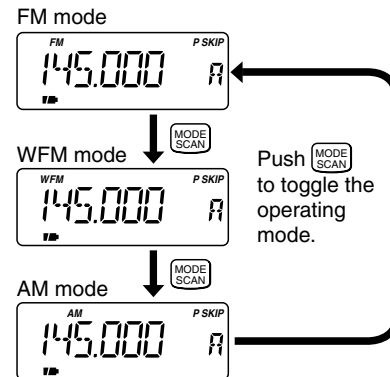

■ Setting the squelch level

The squelch circuit mutes the received audio signal depending on the signal strength. The transceiver has 9 squelch levels, a continuously open setting and an automatic squelch setting.

◇ Setting the squelch level

- ① While pushing and holding [SQL], rotate [DIAL] one-click to display the current squelch level.
- ② Rotate [DIAL] successively to adjust the squelch level.
 - “LEVEL1” is loose squelch and “LEVEL9” is tight squelch.
 - “AUTO” indicates automatic level adjustment with a noise pulse count system.

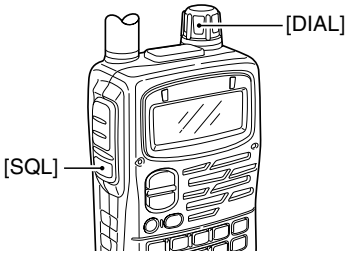

- ③ Release [SQL] to return to the previous indication.

[Squelch level indication]

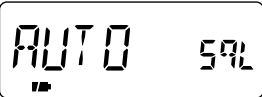

Indication	Squelch level
OPEN	Open
AUTO	Automatic (default)
LEVEL1	Level 1 (loose)
LEVEL2	Level 2
LEVEL3	Level 3
LEVEL4	Level 4
LEVEL5	Level 5
LEVEL6	Level 6
LEVEL7	Level 7
LEVEL8	Level 8
LEVEL9	Level 9 (tight)

◇ Monitor function

This function is used to listen to weak signals or to open the tone squelch manually.

- Push and hold [SQL] to monitor the operating frequency.

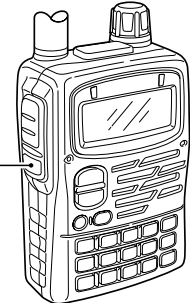

Blinks while monitoring.

▨ The [SQL] switch can be set as a monitor ON/OFF switch in set mode. (p. 60)

4 BASIC OPERATION

■ Receiving

◇ Setting volume level

➡ Push [▲] or [▼] to set the desired audio level.

- Rotating the tuning dial while pushing [▲] or [▼] also sets the audio level.

◇ Setting squelch level

① While pushing [SQL], rotate [DIAL] to select the squelch level.

- “LEVEL1” is loose squelch and “LEVEL9” is tight squelch.

② Release [SQL] to return to the previous indication.

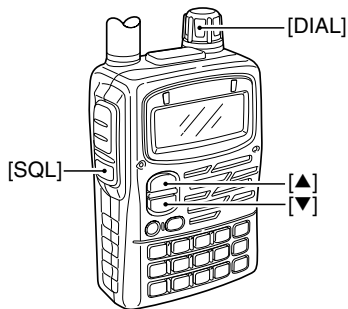

◇ Exchange [DIAL] and [▲]/[▼] functions

The functions of tuning dial and [▲]/[▼] switches can be exchanged, if desired.

➡ Push [1 V↔D] for 1 sec. to exchange the functions of the tuning dial and [▲]/[▼] switches.

- “VOL” appears when the functions are exchanged.

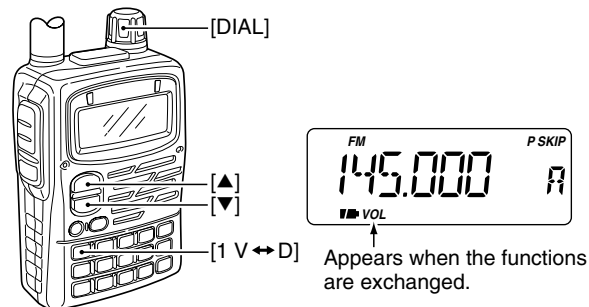

	Default setting	Exchanged setting
[DIAL]	Frequency setting Memory channel setting Scan direction setting Set mode setting	Volume setting
[▲]/[▼]	Volume setting	Frequency setting Memory channel setting Scan direction setting Set mode setting

◇ Receiving FM broadcast

[EXAMPLE]: Receiving 88.200 MHz.

- ① Select VFO mode with [VFO].
- ② For direct frequency input, push [8], [8], [•], [2], [0], [0].
 - Skip ③ and ⑤ in this case.
- ③ Push [BAND] several times to select the FM broadcast band.
 - Default frequency (FM broadcast band): 76.000 or 88.000 MHz
- ④ Push [MODE] several times to select WFM mode if required.
- ⑤ Rotate [DIAL] to set 88.200 MHz.
- ⑥ When a signal is received:
 - ➔ The TX/RX indicator lights green.
 - ➔ Squelch opens and audio is emitted from the speaker.
 - ➔ The S/Rf indicator shows the relative signal strength.

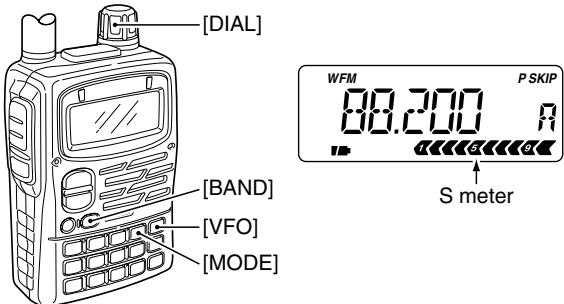

◇ Receiving amateur bands

[EXAMPLE]: Receiving 145.600 MHz.

- ① Select VFO mode with [VFO].
- ② For direct frequency input, push [1], [4], [5], [•], [6], [0], [0].
 - Skip ③ and ⑤ in this case.
- ③ Push [BAND] several times to select the 144 MHz band.
 - Default frequency (144 MHz band): 145.000 MHz
- ④ Push [MODE] several times to select FM mode if required.
- ⑤ Rotate [DIAL] to set 145.600 MHz.
- ⑥ When a signal is received:
 - ➔ The TX/RX indicator lights green.
 - ➔ Squelch opens and audio is emitted from the speaker.
 - ➔ The S/Rf indicator shows the relative signal strength.

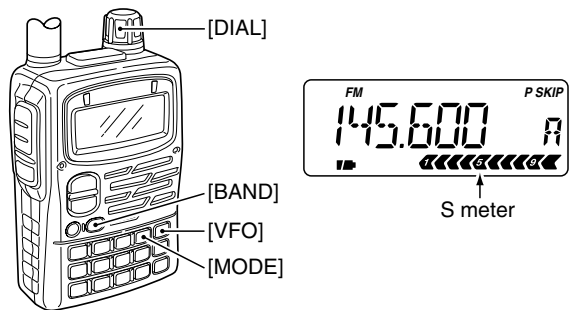

4 BASIC OPERATION

◇ Receiving TV channels

Available TV channels depends on the version. Refer to the TV frequency table (p. 83) for details. Some channels are set as skip channels. Refer to the skip channel setting (p. 26) for details. TV channel frequency and skip setting can be re-programmed via the CS-T90A cloning software, ask your dealer for details.

- ① Select TV mode with [CALL/TV].
 - Pushing [CALL/TV] toggles a call, TV and weather channel (p. 77; U.S.A. version only) in sequence.
- ② Rotate [DIAL] to select the desired TV channel.
 - Rotate [DIAL] while pushing [BAND] to select all TV channels.
- ③ When a signal is received:
 - The TX/RX indicator lights green.
 - Squelch opens and audio is emitted from the speaker.
 - The S/RF indicator shows the relative signal strength.

/// Pushing [CALL/TV] selects the call channel and does not return to the previous TV channel even if the previous mode (VFO or memory) is selected from TV channel.

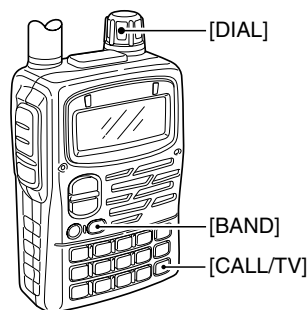

TV channel indication TV mode indication

◇ TV skip scan

The transceiver automatically programs the receivable TV channels as non-skip channels and others as skip channels.

- ① Select TV mode with [CALL/TV].
 - Pushing [CALL/TV] selects a call, TV and weather channel (U.S.A. version only) in sequence.
- ② Push [MODE SCAN] for 1 sec. to start TV skip scan.
 - The transceiver automatically scans all TV channels.
- ③ When the scan is finished:
 - ➔ The receivable TV channels have been programmed as non-skip channels and others as skip channels.
 - ➔ Rotate [DIAL] to select the receivable TV channel.
 - ➔ Rotate [DIAL] while pushing [BAND] to select all TV channels.

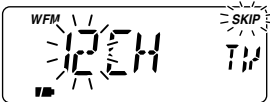
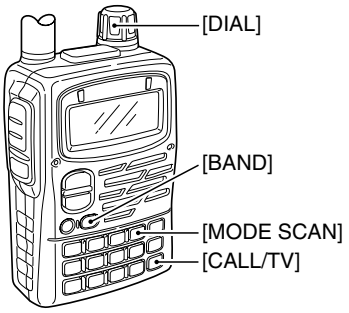

◇ TV skip channel setting

The skip channel setting can be set manually.

- ① Select TV mode with [CALL/TV].
 - Pushing [CALL/TV] selects a call, TV and weather channel (U.S.A. version only) in sequence.
- ② Rotate [DIAL] while pushing [BAND] to select the desired TV channel.
- ③ Push [5 SKIP] for 1 sec. to toggle the skip setting.
 - "SKIP" appears when the channel is set as a skip channel.

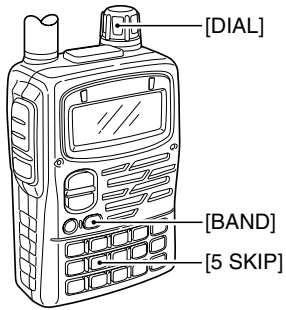

4 BASIC OPERATION

■ RIT function

To compensate for the off frequency of a transmitting station, the transceiver has receive incremental tuning for receiving frequencies above 630.000 MHz. The RIT function cannot be used in TV mode and is automatically cancelled below 630.000 MHz.

The receive incremental tuning (RIT) shifts only the receive frequency within approx. ± 5 kHz.

- ① Set an operating frequency above 630.000 MHz.
- ② Push [0 RIT] for 1 sec. to select the RIT set mode item.
 - If "ATT" appears, rotate [DIAL] to select "RIT."
- ③ Push [0 RIT] again to select the RIT set mode.

RIT set mode

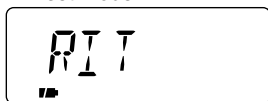

RIT function OFF

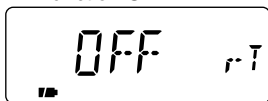

- ④ Rotate [DIAL] to adjust the shift frequency.
 - -5 to +5 appears while setting the shift frequency.
- ⑤ Push [VFO] to exit the RIT set mode.

RIT frequency adjustment

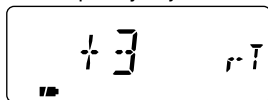

Approx. +3 kHz shift

RIT function example

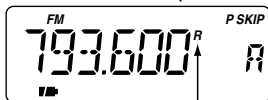

RIT indication

■ Attenuator function

The attenuator prevents a desired signal from distorting when very strong signals are near the desired frequency or when very strong electric fields, such as from a broadcasting station, are near your location. The attenuation level is approx. 10 dB.

- ① Push [0 RIT] for 1 sec. to select the ATT set mode item.
 - "RIT" or "ATT" appears. If "RIT" appears, rotate [DIAL] to select "ATT." When the operating frequency is 629.995 MHz or below, ATT set mode is automatically selected.
- ② Push [0 RIT] again to select the ATT set mode.

RIT/ATT selection menu

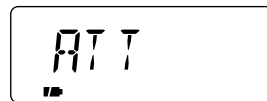

Attenuator set mode



If the operating frequency is 629.995 MHz or below, this menu does not appear.

- ③ Push [VFO] to exit the ATT set mode.

Attenuator is in use



ATT appears

■ Transmitting

◇ Amateur band operation

CAUTION: Transmitting without an antenna may damage the transmitter.

Make sure a charged battery pack or alkaline batteries are installed. (p. 1)

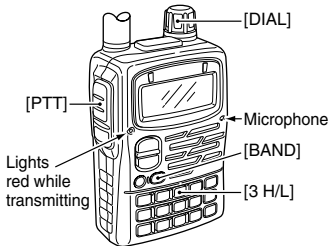

IMPORTANT: To maximize the readability of your transmitted signal, pause a few sec. after pushing [PTT], hold the microphone 1 to 2 inches (2.5 to 5 cm) from your mouth and speak at a normal voice level.

The protect circuit interrupts the output power when more than 11.5 V DC is connected.

◇ Operating band and frequency setting

- ① Select VFO mode with [VFO].
- ② Push [BAND] several times to select the desired amateur band.
 - Rotating the tuning dial while pushing [BAND] also selects the operating band.
- ③ Set an operating frequency with the tuning dial. (p. 19)
 - To input the frequency directly, push [4], [3], [5], [•], [6], [8] and [0] for the example below.

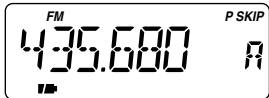

◇ Selecting output power and transmitting

- ① Push [3 H/L] for 1 sec. to select the output power.
 - Rotating the tuning dial while pushing [3 H/L] also toggles the output power.
 - “LOW” appears when low output power is selected. If “LOW” does not appear, high output power is selected.

- ② Push and hold [PTT] to transmit, then speak into the microphone.
 - TX/RX indicator lights red.
 - The S/R/F indicator shows the output power selection.
 - Approx. output power:
 - 4.5 W/0.5 W with 11 V DC (w/CP-19)
 - 5.0 W/0.5 W with BP-217
 - 0.1 W with BP-216 (fixed to low power)
 - ▨ The output power is fixed to low while operating with battery case.
- ③ Release [PTT] to receive.

When LOW power is selected.



When HIGH power is selected.



◇ FM narrow mode (transmit only)

The transceiver has narrow deviation (±2.5 kHz) mode. Set narrow mode in expanded set mode 2, if desired. (p. 66)

4 BASIC OPERATION

■ Repeater operation

When using a repeater, the transmit frequency is shifted from the receive frequency by the offset frequency. (p. 31) It is convenient to program repeater information into memory channels. (p. 37)

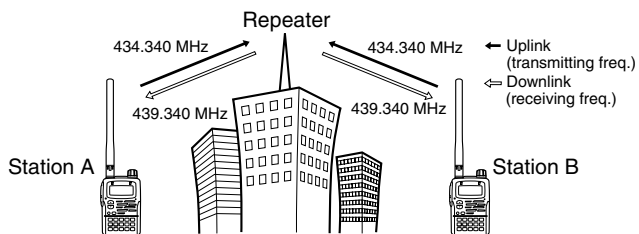

- ① Set the receive frequency (repeater output frequency).
- ② Set the shift direction of the transmit frequency. (-DUP or DUP; see p. 31 for details.)
 - When the auto repeater function is in use (U.S.A. and Korea versions only), this selection and step ③ are not necessary. (p. 33)

"DUP" appears.

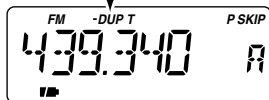

- ③ Push [2 TONE] for 1 sec. to activate the subaudible tone encoder, according to repeater requirements.
 - "T" appears. Refer to p. 70 for tone frequency settings.

- ④ Push and hold [PTT] to transmit.

- The displayed frequency automatically changes to the transmit frequency (repeater input frequency).
- If "OFF" appears, check the offset frequency or shift direction. (p. 31)

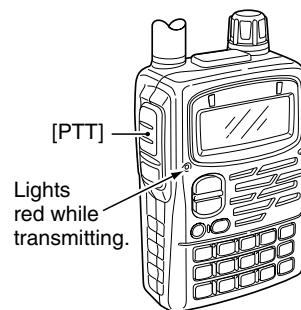

While receiving

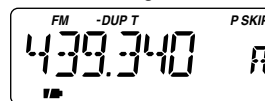

While transmitting

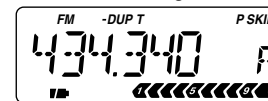

- ⑤ Release [PTT] to receive.
- ⑥ Push and hold [SQL] to check whether the other station's transmit signal can be directly received or not.

U.S.A. and Korea versions:

Auto repeater function uses the settings of the repeater tone frequency and offset frequency.

◇ Checking the repeater input signal

The transceiver can check whether the other station's transmit signal can be received directly or not.

- ➔ Push and hold [SQL] to check whether the other station's transmit signal can be directly received or not.
 - When the other station's signal can be directly received, move to a non-repeater frequency with simplex. (duplex OFF)

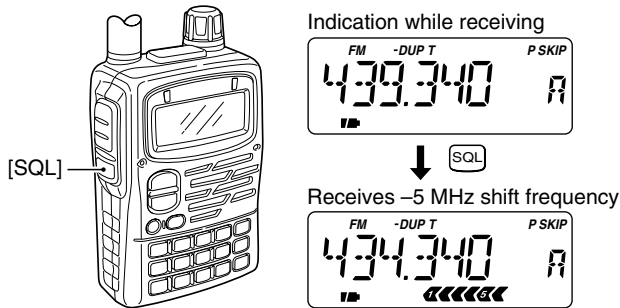

◇ Off band indication

If the transmit frequency is out of the amateur band, the off band indication "OFF" appears on the display when [PTT] is pushed. Check the offset frequency or duplex direction in this case. (p. 31)

/// U.S.A. and Korea versions:

/// Auto repeater function uses the setting of the offset frequency.

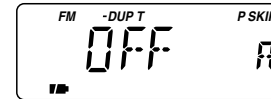

▷ CONVENIENT

Tone scan function: When you don't know the subaudible tone used for a repeater, the tone scan is convenient for detecting the tone frequency.

- ➔ Push [7 T.SCAN] for 1 sec. to activate. See p. 73 for more information.

4 BASIC OPERATION

■ Duplex operation

◇ Setting offset frequency

When communicating through a repeater, the transmit frequency is shifted from the receive frequency by an amount determined by the offset frequency.

- 1 Select VFO mode or desired memory channel to be programmed.
- 2 Push [8 SET] for 1 sec. to enter set mode.
- 3 Rotate [DIAL] until "OFFSET" appears.
- 4 Push [8 SET] again to select offset frequency.
- 5 Rotate [DIAL] to set the desired offset frequency.
 - The tuning step becomes the selected tuning step.
 - Push [VFO MHz] for 1 sec. to use the MHz tuning step, if desired.
- 6 Push [VFO] to exit set mode.

No offset frequency

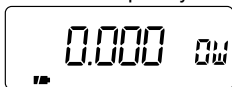

5.0 MHz offset



20.0 MHz offset

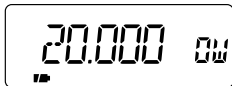

U.S.A. and Korea versions:

Auto repeater function uses the setting of the offset frequency. Take care the offset frequency. (p. 33)

◇ Setting duplex direction

- Push [4 DUP] for 1 sec. to select "-DUP" or "DUP".
 - "-DUP" or "DUP" indicates the transmit frequency for minus shift or plus shift, respectively.

•When offset frequency is 500 kHz.

-Duplex example

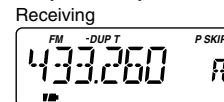

Transmitting

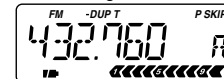

+Duplex example

Receiving

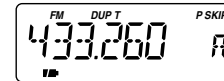

Transmitting

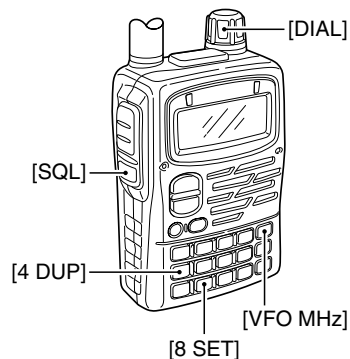
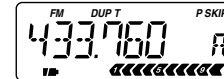

U.S.A. and Korea versions:

Auto repeater function has priority over the manual duplex setting. If the frequency changes after setting, the auto repeater function may have changed the duplex setting.

Split operation

Split frequency operation allows you to transmit and receive on two different frequencies in the same band. The split frequency operation is performed using 2 frequencies, one in VFO A and one in B.

Setting split frequency operation

- ① Push [8 SET] for 1 sec. to enter set mode.
- ② Rotate [DIAL] until "EXP2" appears.
- ③ Push [8 SET] to select expanded set mode 2.
- ④ Rotate [DIAL] to turn the expanded set mode 2 ON.



- ⑤ Push [8 SET] to exit expanded set mode 2.
- ⑥ Rotate [DIAL] until "SPLIT" appears.
- ⑦ Push [8 SET] to select split function.
- ⑧ Rotate [DIAL] to select split function ON or OFF.



- ⑨ Push [VFO] to exit set mode.



•"SPA" or "SPB" appears and the split frequency operation is activated.

Split frequency operation example

[EXAMPLE]: VFO A FM 145.240 MHz
 VFO B FM 145.340 MHz

- ① Push [VFO] several times to select VFO A.
 - Pushing [VFO] toggles VFO A and B.
- ② Push [BAND] several times to select the 144 MHz band.
- ③ Push [MODE] several times to select FM mode.
- ④ Set the operating frequency to 145.240 MHz with the tuning dial.
- ⑤ Push [VFO] to select VFO B.
- ⑥ Push [BAND] several times to select the 144 MHz band.
- ⑦ Push [MODE] several times to select FM mode.
- ⑧ Set the operating frequency to 145.340 MHz.
- ⑨ Push [PTT] to start the split frequency operation.

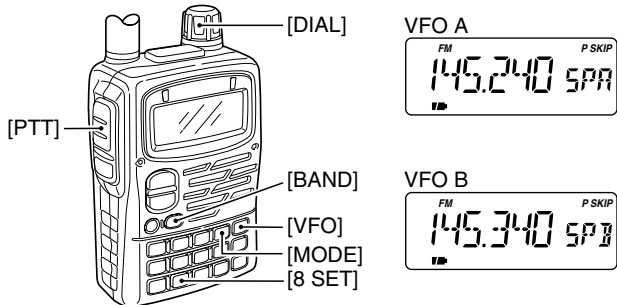

4 BASIC OPERATION

■ Auto repeater function

(U.S.A. and Korea versions only)

The U.S.A. and Korea versions automatically activate the repeater settings (duplex ON/OFF, duplex direction, tone encoder ON/OFF) when the operating frequency falls within or outside of the general repeater output frequency range. The offset and repeater tone frequencies are not changed by the auto repeater function, reset these frequencies, if necessary.

◇ Frequency range and offset direction

•U.S.A. version

FREQUENCY RANGE	SHIFT DIRECTION
51.620– 51.995 MHz 52.500– 52.995 MHz 53.500– 53.995 MHz	“-DUP” appears
145.200–145.495 MHz 146.610–146.995 MHz	“-DUP” appears
147.000–147.395 MHz	“DUP” appears
442.000–444.995 MHz	“DUP” appears
447.000–449.995 MHz	“-DUP” appears

•Korea version

FREQUENCY RANGE	SHIFT DIRECTION
439.000–440.000 MHz	“-DUP” appears

- ① Select VFO mode with [VFO].
- ② Push [8 SET] for 1 sec. to enter set mode.
- ③ Rotate [DIAL] until “AUTORP” appears.
- ④ Push [8 SET] to select auto repeater set mode.
- ⑤ Rotate [DIAL] to turn the auto repeater function ON (DUP ONLY or DUP TONE) or OFF.

U.S.A. version:

- “DUP ONLY” Activates duplex only.
- “DUP TONE” Activates duplex and tone.
- “OFF” Auto repeater function is turned OFF.

Korea version:

- “ON” Activates duplex and tone.
- “OFF” Auto repeater function is turned OFF.

- ⑥ Push [VFO] to exit set mode.

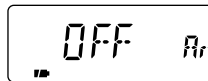

Auto repeater function is turned OFF.

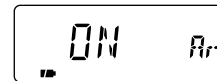

Duplex and tone activated.

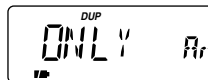

Duplex activated only.



Duplex and tone activated.

■ 1750 Hz tone

Some European repeaters require a 1750 Hz tone to be accessed. For such European repeaters, perform the following.

- This tone can be used as a 'Call signal' in countries out of Europe.

- ① Push [•DTMF.M] for 1 sec. to select DTMF memory.

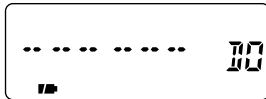

- ② Rotate [DIAL] counter-clockwise until "T-CALL" appears.

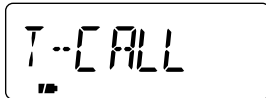

- ③ Push [VFO] to exit DTMF memory.
- ④ Set the receive frequency (repeater output frequency).
- ⑤ Set the shift direction of the transmit frequency. (-DUP or DUP; see p. 31 for details.)
- ⑥ While pushing [PTT], push [SQL] for 1 to 2 sec. to transmit a 1750 Hz tone burst signal.
 - If "OFF" appears, check the offset frequency or shift direction. (p. 31)
 - The displayed frequency automatically changes to the transmit frequency (repeater input frequency).

- ⑦ Push and hold [PTT] to transmit.
- ⑧ Release [PTT] to receive.
- ⑨ Push and hold [SQL] to check whether the other station's transmit signal can be received directly or not.

■ General

The transceiver has 500 memory channels, 50 scan edge channels and 5 call channels for storage of often-used frequencies.

Memory channels can be named with 6 characters and assigned to 18 banks.

◇ Memory/call channel contents

The following information can be programmed into memory or call channels:

- Operating frequency (p. 19)
- Receive mode (p. 21)
- Tuning step (p. 18)
- Duplex direction (DUP or –DUP) with an offset frequency (p. 31)
- Subaudible tone encoder, tone squelch or DTCS squelch ON/OFF (pgs. 29, 71)
- Subaudible tone and tone squelch frequencies (p. 70)
- DTCS code with code phase mode (pgs. 65, 70)
- Memory bank (p. 41)
- Memory name (p. 39)
- Scan skip setting (p. 48)

◇ Default memory contents example

CHANNEL	DESCRIPTION																
000–499 (Memory channel; Mch)	<ul style="list-style-type: none"> • Regular memory channel • Default memory channel example <table style="margin-left: 20px;"> <tr> <td>Mch 000</td> <td>51.000 MHz</td> </tr> <tr> <td>Mch 001</td> <td>145.000 MHz</td> </tr> <tr> <td>Mch 002</td> <td>430.000 MHz</td> </tr> </table> <p>*Mch 003–499 are blank channels.</p>	Mch 000	51.000 MHz	Mch 001	145.000 MHz	Mch 002	430.000 MHz										
Mch 000	51.000 MHz																
Mch 001	145.000 MHz																
Mch 002	430.000 MHz																
0A/0B– 24A/24B (Scan edge channel)	<ul style="list-style-type: none"> • Program scan edge channel 25 pairs (50 channels) • Default scan edge example <table style="margin-left: 20px;"> <tr> <td>0A:</td> <td>0.495 MHz</td> <td>0B:</td> <td>440.000 MHz</td> </tr> <tr> <td>1A:</td> <td>50.000 MHz</td> <td>1B:</td> <td>52.000 MHz</td> </tr> <tr> <td>2A:</td> <td>144.000 MHz</td> <td>2B:</td> <td>146.000 MHz</td> </tr> <tr> <td>3A:</td> <td>430.000 MHz</td> <td>3B:</td> <td>440.000 MHz</td> </tr> </table> <p>*4A/4B–24A/24B are blank channels.</p>	0A:	0.495 MHz	0B:	440.000 MHz	1A:	50.000 MHz	1B:	52.000 MHz	2A:	144.000 MHz	2B:	146.000 MHz	3A:	430.000 MHz	3B:	440.000 MHz
0A:	0.495 MHz	0B:	440.000 MHz														
1A:	50.000 MHz	1B:	52.000 MHz														
2A:	144.000 MHz	2B:	146.000 MHz														
3A:	430.000 MHz	3B:	440.000 MHz														
C0–C4 (Call channel)	<ul style="list-style-type: none"> • Calling channel for amateur bands • Can be used as regular memory channel • Default call channel example <table style="margin-left: 20px;"> <tr> <td>C0</td> <td>51.000 MHz</td> </tr> <tr> <td>C1</td> <td>145.000 MHz</td> </tr> <tr> <td>C2</td> <td>430.000 MHz</td> </tr> </table> <p>*C3 and 4 are blank channels.</p>	C0	51.000 MHz	C1	145.000 MHz	C2	430.000 MHz										
C0	51.000 MHz																
C1	145.000 MHz																
C2	430.000 MHz																

■ Calling up memory channels

Memory channels can be selected with the [DIAL] and keypad.

- Blank channels cannot be selected via [DIAL].
- Blank channels can be selected via keypad.
- Previously selected channels appear when the wrong memory channel number is entered.

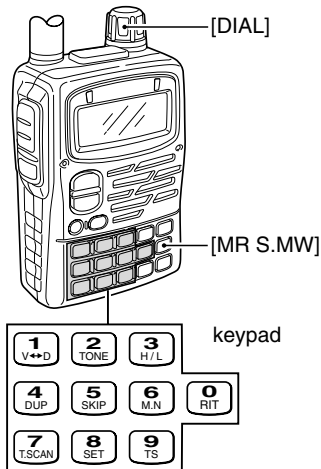

◇ Selecting with tuning dial

- ① Push [MR] to select memory mode.
- ② Rotate [DIAL] to select the desired memory channel.

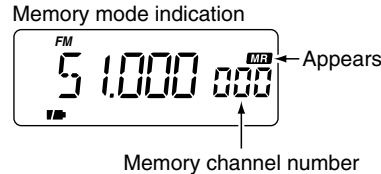

◇ Selecting with keypad

- ① Push [MR] to select memory mode.
- ② Push the desired numeral keys to select the desired memory channel.
 - Selecting memory channel 001. Push [0], [0] and [1].
 - Selecting memory channel 056. Push [0], [5] and [6].
 - Selecting memory channel 499. Push [4], [9] and [9].

▷ CONVENIENT

The memory channels (000–099) can be selected with 1 or 2 digits plus [MR].

- Selecting memory channel 005. Push [5] and [MR].
- Selecting memory channel 024. Push [2], [4] and [MR].

◇ Check contents of all memory channels

- ① Push [MR S.MW] for 1 sec. to enter memory write condition.
 - Memory channel readout blinks.



- ② Rotate [DIAL] to check the desired memory channel.

Rotating [DIAL] while pushing [BAND] also selects all memory channels.

5 MEMORY/CALL CHANNELS

■ Programming memory channels

Program the desired frequency into a memory channel, call channel or scan edge channel as follows.

The memory channels are shared with all bands. Memory channels 003–499 are blank (non-programmed) channels as a factory setting.

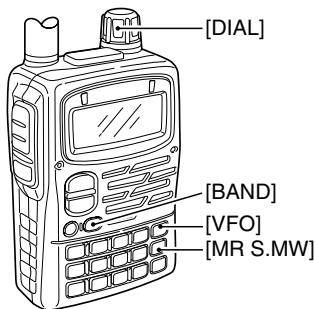

◇ Programming a memory channel

[EXAMPLE]: 433.520 MHz into Mch 11

- ① Select VFO mode with [VFO].
- ② Set the desired frequency:
 - Select the desired band with [BAND].
 - Set the frequency using [DIAL].
 - Set other data (e.g. offset frequency, duplex direction, subaudible tone frequency, etc.), if required.
- ③ Push [MR S.MW] for 1 sec. to indicate memory channels.
 - Memory channel indicator “**MR**” and channel readout blinks.
 - Do not hold [MR S.MW] for more than 2 sec., otherwise the previously selected memory channel contents will be overwritten.
- ④ Rotate [DIAL] to select the desired channel.
 - Call channels (C0–C4), VFO (VF) and scan edge channels (0A/0B–24A/24B), as well as regular memory channels, can be programmed in this way.
- ⑤ Push [MR S.MW] for 1 sec. to program.

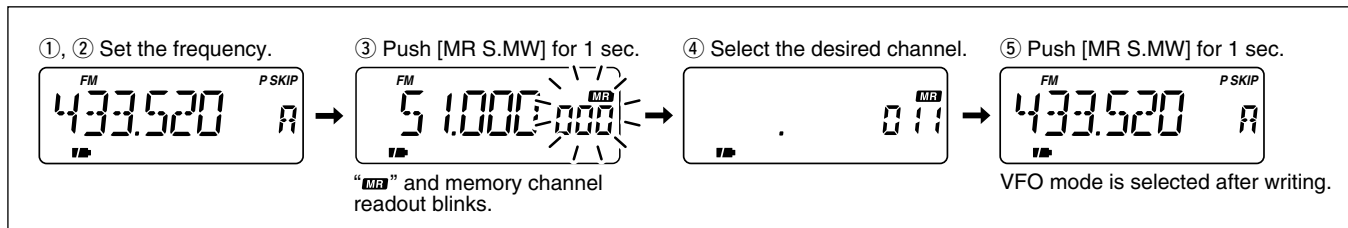

◇ **Auto memory channel increment**

While programming a memory channel, the next memory channel can be selected automatically. This is convenient when programming memory channels one after another.

➔ Keep pushing [MR S.MW] for 2 sec. or more, at step ⑤ of the left section, to select the next memory channel automatically.

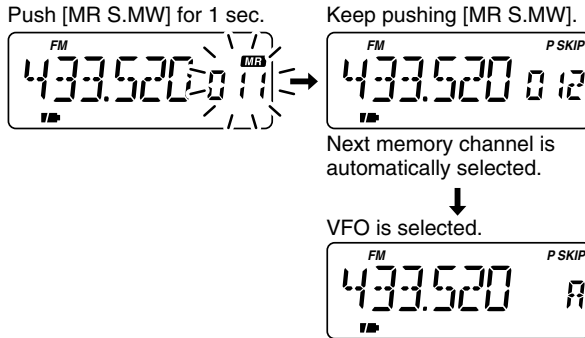

■ **Transferring memory contents to VFO**

This is convenient when operating around a memory or call channel.

- ① Push [VFO] several times to select VFO A or B to be transferred.
- ② Push [MR] to select memory mode.
- ③ Set the desired memory channel with [DIAL].
 - Call or scan edge channel contents can be transferred in the same manner. Select a call channel in this case.
- ④ Push [MR S.MW] for 2 sec. to transfer.

[EXAMPLE]: Transferring memory channel 26 to VFO A.

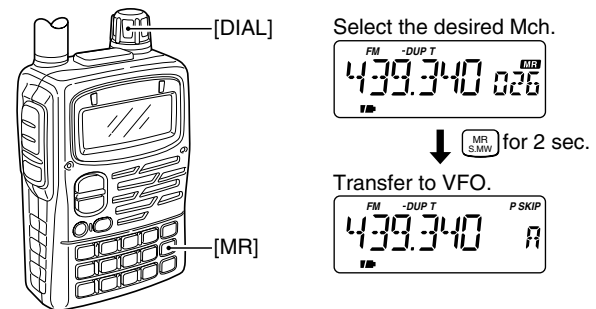

5 MEMORY/CALL CHANNELS

■ Copying memory contents

This is convenient when programming memory contents into a scan edge channel or call channel.

- Call or scan edge channel contents can be copied in the same manner.
- ① Push [MR S.MW] to select memory mode.
 - ② Select the memory channel to be copied with [DIAL].
 - ③ Push [MR S.MW] for 1 sec.
 - Memory channel indicator and number blinks.
 - Do not hold [MR S.MW] for more than 2 sec., otherwise the previously selected VFO will be overwritten.
 - ④ Rotate [DIAL] to select the target memory channel.
 - ⑤ Push [MR S.MW] for 2 sec. to copy.

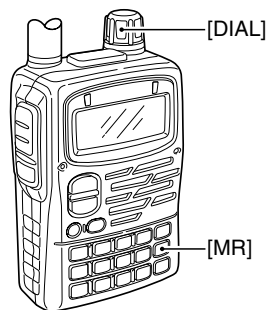

Select a channel to copy.

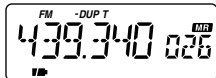

Select desired channel.



Write into the channel.

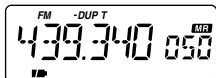

■ Memory names

Each memory, scan edge and call channels can be programmed with an alphanumeric name such as a repeater name, club name, etc., for easy recognition. Names can be a maximum of 6 characters—see the table at right for available characters.

◇ Memory name input

- ① Push [MR] to select memory mode.
- ② Set the desired memory channel with [DIAL].

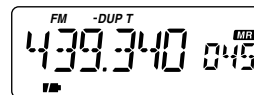

- ③ Push [MR S.MW] for 1 sec. to indicate the memory channel.
 - Memory channel indicator blinks.
 - Do not hold [MR S.MW] for more than 2 sec., otherwise the previously selected VFO will be overwritten.
- ④ Push [CALL/TV] several times to select “NAME.”
 - Memory name screen appears. The 1st character of the name and “MR” blinks.
 - Previously programmed name appears, if programmed.

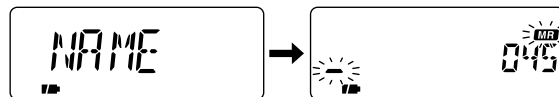

- ⑤ Rotate the tuning dial to select the desired character.
 - See the following list for available characters.
- ⑥ Push [BAND] to advance the cursor.
 - Rotating the tuning dial while pushing [BAND] also selects the character.



- ⑦ Repeat ⑤ and ⑥ until the desired name is input.
- ⑧ Push [VFO] to program the name.
- ⑨ If you want to set other channels, repeat ② through ⑧ to set the desired name.

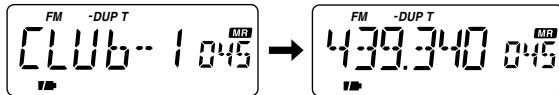

• Available characters

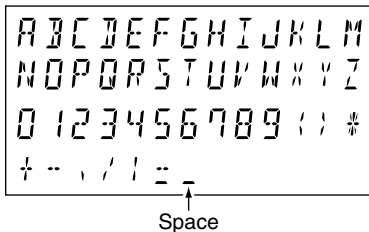

▨ The memory names are automatically programmed into the memory channels.

◇ Memory name indication

Turn the memory name indication ON and OFF as follows.

- ➔ Push [6 M.N] for 1 sec. to toggle the memory name indication ON and OFF.
 - Frequencies are displayed for the memory channels which do not have memory names. You cannot display both.
 - To change the memory name, program a new memory name again.

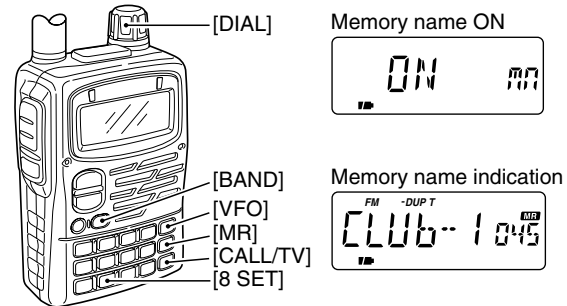

5 MEMORY/CALL CHANNELS

■ Memory bank

The transceiver has 500 memory channels that can be assigned to 18 banks for faster memory access, memory arrangement, etc.

Each bank (A–H, J, L, N–R, T, U and Y) can be assigned up to 100 memory channels.

Mch contents	Memory bank	Memory bank contents
000 51.000 MHz	A00	A 00–99 144 MHz Repeater*
001 145.000 MHz		
002 433.000 MHz		
003 145.120 MHz	B00	B 00–99 440 MHz Repeater*
004 435.340 MHz		
005 145.040 MHz		
006 433.560 MHz	A01	D 00–99
007 850.480 MHz		
008 52.560 MHz		
009 1.620 MHz	B01	E 00–99
010 50.140 MHz		
011 118.200 MHz		
012 76.500 MHz	C00	F 00–99
013 118.125 MHz		
014 145.540 MHz		
015 369.850 MHz	A02	G 00–99
016 434.720 MHz		
017 848.98750 MHz		
018 852.720 MHz	B02	H 00–99
019 75.795 MHz		
020 127.700 MHz		
021 146.300 MHz	C01	J 00–99
}		
}	C02	L 00–99
}	A03	N 00–99
}	C03	O 00–99
499 119.870 MHz		P 00–99
		Q 00–99
		R 00–99
		T 00–99
		U 00–99
		Y 00–99

*Above sample is collected 144 MHz Repeater channels to bank A and 440 MHz Repeater channels to bank B.

Memory banks are used for arrangement of a memory channel. When you edit the original memory channel contents, the memory bank contents are updated automatically.

◇ Setting a memory bank

- ① Push [MR] to select memory mode.
- ② Set the desired memory channel with [DIAL].
- ③ Push [MR S.MW] for 1 sec. to indicate a memory channel.
 - Memory channel indicator blinks.
 - Do not hold [MR S.MW] for more than 2 sec., otherwise the previously selected VFO will be overwritten.
- ④ Push [CALL/TV] several times to select “BANK.”
 - Memory bank screen appears.
 - Previously programmed memory bank appears, if programmed.
- ⑤ Push [BAND] to select a memory bank.
 - Rotating the tuning dial while pushing [BAND] also selects the memory bank.
 - Select “----” to clear the memory bank information.
- ⑥ Rotate the tuning dial to select the desired channel.
 - Previously used memory bank channel cannot be selected.
- ⑦ Push [VFO] to program the memory bank channel.



- ① Push [MR] to select memory mode.
- ② Select Mch with [DIAL].



- ③ Push [MR S.MW] for 1 sec. to indicate Mch.



Memory channel indicator flashes.

- ④ Push [CALL/TV].

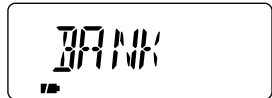

Each push selects BANK, NAME, SKIP, CLEAR and S.MW in sequence.

Release [CALL/TV].

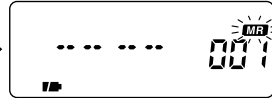

- ⑤ Push [BAND] to select memory bank.
- ⑥ Rotate [DIAL] to select memory bank channel.



Memory bank and channel.

- ⑦ Push [VFO].



Memory bank is programmed and memory mode is selected.

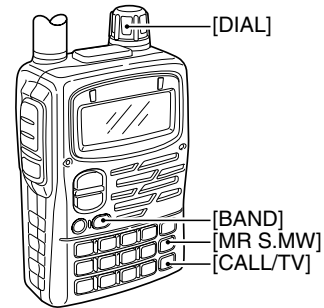

- Push [BAND] to select the memory bank in sequence.
- Pushing [MR] toggles the memory channel indication and memory bank indication.

Memory channel indication

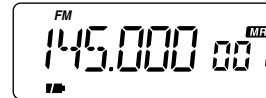

Memory bank indication

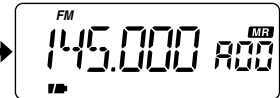

5 MEMORY/CALL CHANNELS

■ Memory clear

Unwanted memory channels can be cleared (erased). Before clearing a memory channel make sure it is no longer needed as cleared memories cannot be recalled. Scan edges (0A/0B) cannot be cleared.

- ① Push [MR S.MW] for 1 sec. to indicate a memory channel.
 - Memory channel indicator blinks.
 - Do not hold [MR S.MW] for more than 2 sec., otherwise the previously selected VFO or memory channel will be overwritten.
- ② Select the memory channel to be cleared with [DIAL].
 - Scan edges (0A/0B) cannot be cleared.

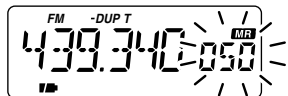

- ③ Push [CALL/TV] several times to select "CLEAR."

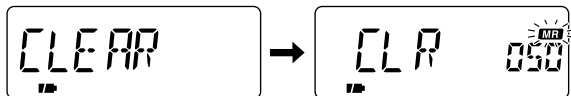

- ④ Push [MR S.MW] for 1 sec. to clear the selected memory channel.
 - 3 beeps sound, then the frequency is cleared.

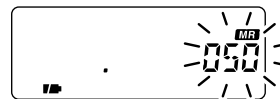

- ⑤ Push [VFO] to return to the previous mode.

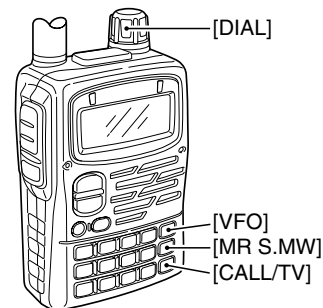
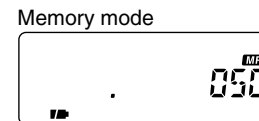
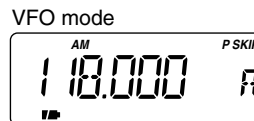

■ Call channel

5 call channels are available to store the most-often-used frequencies for quick recall.

The call channels can be programmed in a similar manner to memory channel programming.

- Select C0–C4 for programming call channels 0–4 in step ④ in “Programming memory channels.” (p. 37)

◇ Selecting a call channel

- ① Push [CALL/TV] to select a call channel.
 - Pushing [CALL/TV] selects a call, TV and weather (U.S.A. version only) channel in sequence.
- ② Rotate [DIAL] counterclockwise or clockwise to select a programmed call channel.
 - Rotating [DIAL] while pushing [BAND] selects all call channels.
- ③ Push [VFO] or [MR] to return to the previously selected mode.

• Call channel example (depends on version)

50MHz band call channel



UHF band call channel



VHF band call channel

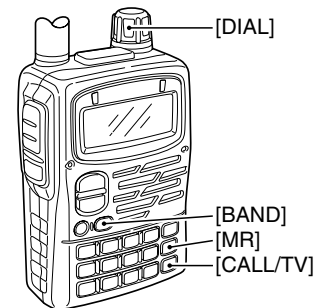
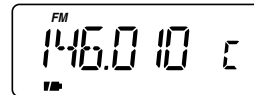

6

SCAN OPERATION

Scan types

◇ VFO scans

FULL SCAN (p. 46)

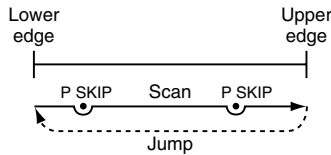

Repeatedly scans all frequencies over the entire receive range.

- Some frequency ranges are restricted depending on versions.

BAND SCAN (p. 46)

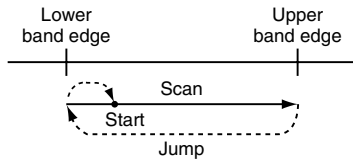

Repeatedly scans all frequencies over the entire selected band.

PROGRAMMED SCAN (p. 46)

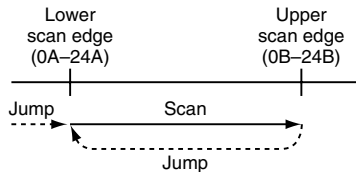

Repeatedly scans between two user-programmed frequencies. Used for checking for frequencies within a specified range such as repeater output frequencies, etc.

Up to 25 programmed scan ranges (0A/0B to 24A/24B), full memory scan, select band scan and memory bank scan provide scanning versatility. Each scan can have skip channels programmed.

◇ Memory scans

FULL MEMORY SCAN (p. 48)

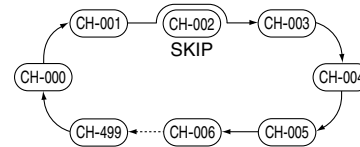

Repeatedly scans all memory channels except skip channels.

SELECT BAND SCAN (p. 48)

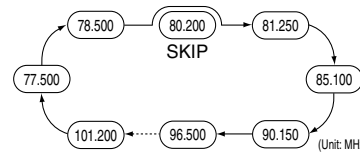

Repeatedly scans memory channels except skip channels within a selected memory band. (e.g. WFM, 144 MHz or 440 MHz memory band, etc.)

BANK SCAN (p. 48)

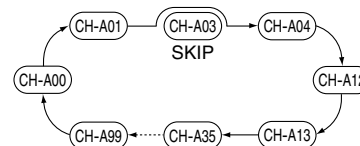

Repeatedly scans memory channels except skip channels within a specified memory bank (i.e. memory Bank, A00-A99).

■ VFO scan

The following scans are available for the VFO scan.

FULL SCAN

Repeatedly scans all frequencies over the entire receive range.

- Some frequency ranges are restricted depending on versions.

BAND SCAN

Repeatedly scans all frequencies over the entire selected band.

PROGRAMMED SCAN

Repeatedly scans between two user-programmed frequencies. Used for checking for frequencies within a specified range such as repeater output frequencies, etc.

/// Skip frequencies are not scanned when the frequency skip function is in use. ("P SKIP" appears)

/// If the same frequencies are programmed into a pair of scan edges, programmed scan does not start.

/// For programmed scan, scan edges must be programmed in advance. Program scan edges in the same manner as programming a memory channel. (p. 37)

- ① Select VFO mode with [VFO].
- ② Push [5 SKIP] for 1 sec. to toggle the frequency skip function ON or OFF.
 - "P SKIP" appears when the frequency skip function is turned ON.
- ③ Set the squelch level, if desired.
- ④ While pushing [MODE SCAN], rotate [DIAL] to select the desired scan range.
 - "ALL" for full scan, "BAND" for band scan or "PROG 0-24" for programmed scan.
- ⑤ Release [MODE SCAN] to start the scan.
 - Decimal point blinks while scanning.
 - "P SKIP" blinks when the frequency skip function is turned ON.
 - To change the scanning direction, rotate [DIAL].
 - If the pocket beep or DTCS beep function is activated, the transceiver automatically selects the tone squelch or DTCS squelch function when a scan starts.
- ⑥ To stop the scan, push [VFO].

Full scan

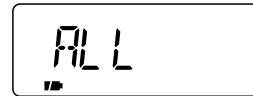

Band scan



Programmed scan

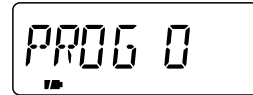

Scanning example

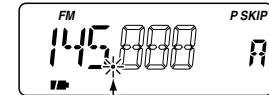

Flashes while scanning.

6 SCAN OPERATION

■ Frequency skip function

Unwanted frequencies can be skipped and programmed as skip channels when full scan, band scan or programmed scan is pausing.

- ① Start a VFO scan. (p. 46)
- ② While receiving an unwanted signal and scan pauses, push [5 SKIP] for 1 sec. to program the received frequency as a skip frequency.
 - The transceiver emits 3 beeps and the scan resumes.
 - Non-programmed memory channels (blank channels) are used for skip frequency programming in reverse sequence.
 - Do not release [5 SKIP] before 1 sec., otherwise the scan stops and the transceiver enters frequency setting condition.

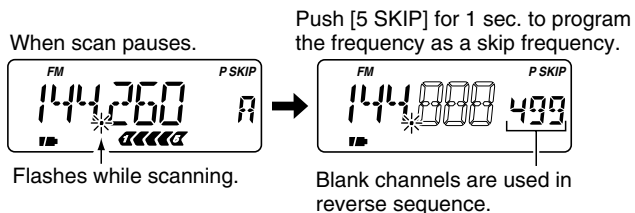

▨ To scan the skip frequency after programming, cancel the skip information or clear the memory channel. (p. 43)

■ Skip channel setting

Memory channels can be set to be skipped for memory skip scan. In addition, memory channels can be set to be skipped for both memory skip scan and frequency skip scan. These are useful to speed up the scan interval.

- ① Select memory mode with [MR].
- ② Rotate [DIAL] to select memory channel to set the skip information.
- ③ Push [5 SKIP] for 1 sec. one or more times to select the condition.
 - “OFF” for no skipping of channels, “SKIP” for memory skip scan or “P SKIP” for frequency skip scan and memory skip scan.

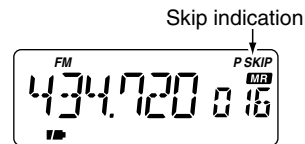

▨ “P SCAN” setting is effective when the frequency skip function is turned ON. (p. 46)

Memory scan

Memory scan repeatedly scans all memory channels except skip channels.

There are 3 types of memory scan, select band scan, full bank scan and bank scan are available.

◇ Full memory scan/Select band scan

- ① Push [MR] to enter memory mode.
- ② While pushing and holding [MODE SCAN], rotate [DIAL] to select from scan-guidance, [ALL], [SEL BC], [SEL 5], [SEL 50], [SEL WFM], [SEL AIR], [SEL 144], [SEL 220], [SEL 300], [SEL 440] or [SEL 800].
 - [ALL] scans full programmed memories except skip channels.
 - Scan-guidance appear(s) for programmed band(s) only.
 - Scan repeatedly scans memory channels except skip channels within a selected memory band.
- ③ Release [MODE SCAN] to start the memory scan.
 - Decimal point blinks while scanning.
 - To change the scanning direction, rotate [DIAL].
 - While receiving an unwanted signal and scan pauses, push [5 SKIP] for 1 sec. to set the received channel as a skip channel.
- ④ Push [VFO] to stop the scan.

◇ Full bank scan/Bank scan

Bank scan repeatedly scans memory channels except skip channels within a selected memory bank.

- ① Push [MR] to enter the memory bank mode.
 - Pushing [MR] toggles the memory channel and memory bank modes.
 - Program 2 or more memory channels to a memory bank in advance.
- ② Push [BAND] several times to select the desired memory bank if desired.
- ③ While pushing [MODE SCAN], rotate [DIAL] to select [ALL] or [BANK].
 - “ALL” scans for full bank or “BANK” scans for within a specified memory bank only.
- ④ Release [MODE SCAN] to start the memory scan.
 - Decimal point blinks while scanning.
 - To change the scanning direction, rotate [DIAL].
- ⑤ Push [VFO] to stop the scan.

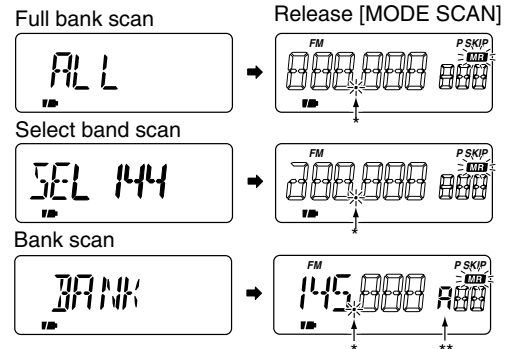

*Flashes while scanning.
**Bank name appears.

6 SCAN OPERATION

■ Scan notes

◇ Squelch setting

Scanning stops when the squelch opens. Make sure the squelch is set to the threshold point or desired squelch level.

- Rotate the tuning dial while pushing [SQL] to select automatic squelch (AUTO) or a level (1–9) where the noise is muted. (p. 22)

◇ Tuning dial operation while scanning

- Scan starts in the upward direction. To change the scanning direction, rotate [DIAL] clockwise or counterclockwise.
- Rotating [DIAL] while a scan is posed, resumes the scan manually.

◇ Tuning step setting while scanning

The tuning step set while scanning becomes the selected tuning step. Reset the tuning step before scanning, if necessary. (p. 18)

◇ Skip function

Memory channels can be set to be skipped for memory skip scan. In addition, memory channels can be set to be skipped for both memory skip scan and frequency skip scan. These are useful to speed up the scan interval. (p. 47)

◇ When receiving a signal

The scan pauses according to the scan pause time (default: 10 sec.). It can be selected as a pause or timer scan (2–20 sec.) in set mode. (p. 58)

The scan restarts after a signal disappears according to the resume time (default: 2 sec.). It can be selected from 0–5 sec. or 'hold' (indefinitely) in set mode. (p. 58)

◇ Scan stop beep

A beep sounds when a scan stops to confirm the scan has detected a signal. This function can be turned ON or OFF in expanded set mode 1. (p. 62)

◇ Scan stop LED

The keypad backlighting blinks when a scan stops to confirm the scan has detected a signal. This function can be turned ON or OFF in expanded set mode 1. (p. 62)

◇ Busy LED ON/OFF

The receive indicator can be turned ON or OFF in set mode. (p. 59)

■ Priority watch types

Priority watch checks for signals on a frequency every 5 sec. while operating on a VFO frequency or scan. The transceiver has 6 priority watch types to suit your needs.

The watch resumes according to the selected scan resume condition. See p. 58 for details.

MEMORY or CALL CHANNEL WATCH

While operating on a VFO frequency, priority watch checks for a signal in the selected memory or call channel every 5 sec.

- A memory channel with skip information can be watched.

MEMORY SCAN WATCH

While operating on a VFO frequency, priority watch checks for signals in each memory channel in sequence.

- The memory skip function is useful to speed up the scan.

VFO SCAN with MEMORY or CALL CHANNEL WATCH

While scanning in VFO mode, priority watch checks for signals in the selected memory or call channel every 5 sec.

VFO SCAN with MEMORY SCAN WATCH

While scanning in VFO mode, priority watch checks for signals in memory channels every 5 sec.

▨ If the pocket beep function is activated, the transceiver automatically selects the tone squelch function when priority watch starts.

■ Priority alert

You can be alerted with beeps and a blinking “(•)”, when a priority watch detects a signal on the watching frequency.

- ① Push [8 SET] for 1 sec. to enter set mode.
- ② Rotate [DIAL] until “PRIO” appears.

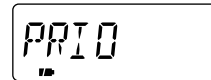

- ③ Push [8 SET] to select the priority watch item.
- ④ Rotate [DIAL] to select the priority alert item. (“BELL”)

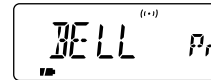

- ⑤ Push [VFO] to exit set mode and start the priority watch.

Priority watch operation

◇ Memory channel watch

While operating on a VFO frequency, priority watch checks for a signal in the selected memory channel every 5 sec.

• A memory channel with skip information can be watched.

- ① Select VFO mode; then, set an operating frequency.
- ② Select the desired memory channel.
- ③ Push [8 SET] for 1 sec. to enter set mode.
- ④ Rotate [DIAL] until "PRIO" appears.
- ⑤ Push [8 SET] to select the priority watch item.
- ⑥ Rotate [DIAL] to select the priority watch ("ON") or priority watch with alert ("BELL").

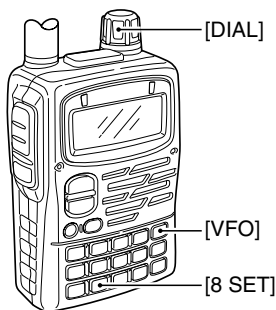

Priority watch item

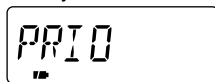

Priority watch with alert

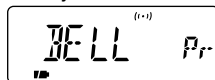

Push [VFO] to start.

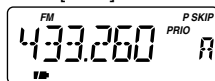

- ⑦ Push [VFO] to exit set mode and start the priority watch.

- The transceiver checks the memory channel frequency every 5 sec.
- The watch resumes according to the selected scan resume condition. (p. 58)

While operating on a VFO frequency

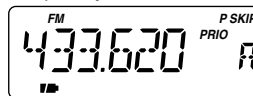

The watch stops on the selected channel when a signal is received.

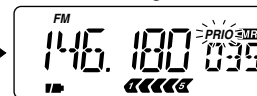

Checks for a signal in the selected memory channel every 5 sec.

- ⑧ Push [VFO] while the display shows the VFO frequency to stop the watch.

◇ VFO scan with memory channel watch

While scanning in VFO mode, priority watch checks for signals in the selected memory channel every 5 sec.

• A memory channel with skip information can be watched.

- ① Select the desired memory channel to be watched.
- ② Select VFO mode.
- ③ Push [MODE SCAN] for 1 sec. to start a VFO scan. (full scan, band scan or programmed scan)
- ④ Push [8 SET] for 1 sec. to enter set mode.
- ⑤ Rotate [DIAL] until "PRIO" appears.
- ⑥ Push [8 SET] to select the priority watch item.
- ⑦ Rotate [DIAL] to select the priority watch ("ON") or priority watch with alert ("BELL").
- ⑧ Push [VFO] to exit set mode and start the priority watch.
- ⑨ Push [VFO] while the display shows the VFO frequency to stop the VFO scan and priority watch.

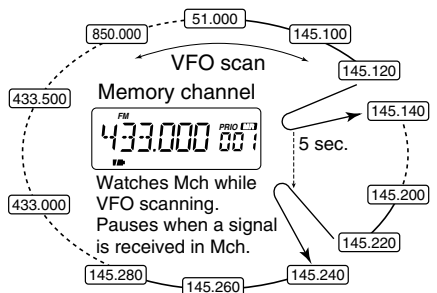

◇ Memory scan watch

While operating on a VFO frequency, priority watch checks for a signal in memory channels every 5 sec.

- ① Select VFO mode; then, set an operating frequency.
- ② Select memory mode.
- ③ Push [MODE SCAN] for 1 sec. to start a memory scan.
- ④ Push [8 SET] for 1 sec. to enter set mode.
- ⑤ Rotate [DIAL] until "PRIO" appears.
- ⑥ Push [8 SET] to select the priority watch item.
- ⑦ Rotate [DIAL] to select the priority watch ("ON") or priority watch with alert ("BELL").
- ⑧ Push [VFO] to exit set mode and start the priority watch.
- ⑨ Push [VFO] while the display shows the VFO frequency to stop the watch.

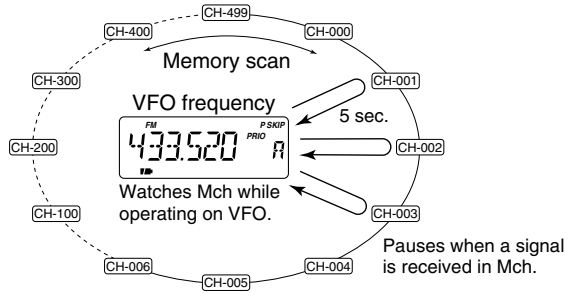

7 PRIORITY WATCH

◇ VFO scan with memory scan watch

While scanning in VFO mode, priority watch checks for signals in memory channels every 5 sec.

- ① Select memory mode.
- ② Push [MODE SCAN] for 1 sec. to start a memory scan.
 - Start the memory scan first, otherwise, memory scan watch does not start.
- ③ Push [8 SET] for 1 sec. to enter set mode.
- ④ Rotate [DIAL] until “PRIO” appears.
- ⑤ Push [8 SET] to select the priority watch item.
- ⑥ Rotate [DIAL] to select the priority watch (“ON”) or priority watch with alert (“BELL”).
- ⑦ Push [VFO] to exit set mode and start the memory scan watch.
- ⑧ Push [MODE SCAN] for 1 sec. to start a VFO scan. (full scan, band scan or programmed scan)
 - VFO scan with memory scan watch is now activated.
 - The scan or watch pauses when a signal is received on a VFO frequency or memory channels select for watch.
- ⑨ Push [VFO] while the display shows the VFO frequency to stop the VFO scan and priority watch.

◇ Call channel watch

While operating on a VFO frequency, priority watch checks for a signal in the selected call channel every 5 sec.

- ① Select VFO mode; then, set an operating frequency.
- ② Push [CALL/TV] to select call channel mode.
- ③ Rotate [DIAL] to select the desired call channel.
- ④ Push [8 SET] for 1 sec. to enter set mode.
- ⑤ Rotate [DIAL] until “PRIO” appears.
- ⑥ Push [8 SET] to select the priority watch item.
- ⑦ Rotate [DIAL] to select the priority watch (“ON”) or priority watch with alert (“BELL”).
- ⑧ Push [VFO] to exit set mode and start the priority watch.
- ⑨ Push [VFO] while the display shows the VFO frequency to stop the watch.

While operating on a VFO frequency

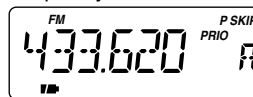

The watch stops on the selected channel when a signal is received.



Checks for a signal in the selected call channel every 5 sec.

◇ VFO scan with call channel watch

While scanning in VFO mode, priority watch checks for signals in the selected call channel every 5 sec.

- ① Select VFO mode.
- ② Push [CALL/TV] to select call channel mode.
- ③ Rotate [DIAL] to select the desired call channel.
- ④ Push [8 SET] for 1 sec. to enter set mode.
- ⑤ Rotate [DIAL] until "PRIO" appears.
- ⑥ Push [8 SET] to select the priority watch item.
- ⑦ Rotate [DIAL] to select the priority watch ("ON") or priority watch with alert ("BELL").
- ⑧ Push [VFO] to exit set mode and start the priority watch.
- ⑨ Push [MODE SCAN] for 1 sec. to start a VFO scan. (full scan, band scan or programmed scan)
- ⑩ Push [VFO] while the display shows the VFO frequency to stop the VFO scan and priority watch.

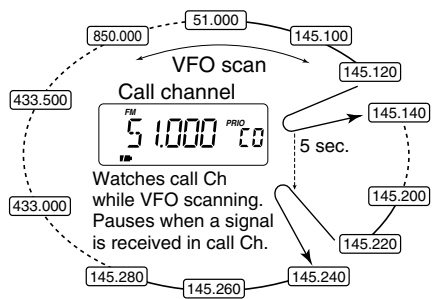

■ Set mode

Set mode is used for programming infrequently changed values or conditions of functions.

In addition, this transceiver has 2 expanded set modes which are used for programming even more infrequently changed values or conditions of functions. When turning the expanded set modes OFF, only half of the set mode items are displayed for simple operation.

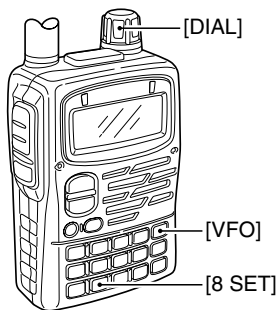

◇ Entering set mode

- ① Push [8 SET] for 1 sec. to enter set mode.
- ② Rotate [DIAL] until the desired item appears.

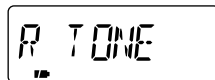

- ③ Push [8 SET] to select the set mode item.

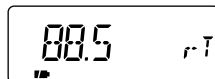

- ④ Rotate [DIAL] to select a set mode item.

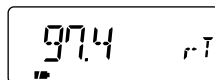

- ⑤ Push [VFO] to exit set mode or push [8 SET] then rotate [DIAL] to select another set mode item.

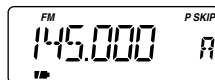

◇ Expanded set mode ON/OFF

- ① Push [8 SET] for 1 sec. to enter set mode.
- ② Rotate [DIAL] until "EXP1" or "EXP2" appears.



- ③ Push [8 SET] to select one of the expanded set modes.
- ④ Rotate [DIAL] to turn the expanded set mode ON or OFF.

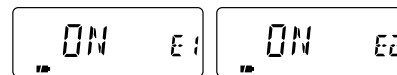

- ⑤ Push [8 SET] then rotate [DIAL] to select a set mode item in the selected expanded set mode, or push [VFO] to exit set mode.

■ Set mode items

Set mode is used for programming infrequently changed values or conditions of functions.

General set mode

R TONE	Repeater tone (p. 57)
C TONE	Tone squelch/pocket beep frequency (p. 57)
CODE	DTCS squelch code (p. 57)
OFFSET	Offset frequency (p. 57)
RESUME	Scan resume time (p. 58)
PAUSE	Scan pause timer (p. 58)
PRIO	Priority watch (p. 58)
BEEPLV	Beep tone level (p. 58)
BEEP	Beep tone (p. 59)
LIGHT	Display backlighting (p. 59)
BUSY	Busy LED (p. 59)
AP OFF	Auto power OFF (p. 59)
P SAVE	Power save (p. 60)
MONI	Monitor switch action (p. 60)
SPEED	Dial speed acceleration (p. 60)
AUTORP	Auto repeater (p. 61)
DTMF	DTMF speed (p. 61)
MIC	Optional HM-75A functions (p. 61)
WX ALT	Weather Alert (p. 62)
EXP1	Expanded set mode 1 (upper right)
EXP2	Expanded set mode 2 (lower right)

EXP1 (Expanded set mode 1)

STOP B	Scan stop beep (p. 62)
STOP L	Scan stop LED (p. 62)
LIGHTP	Backlighting position (p. 62)
COLOR	Backlighting color (p. 63)
EDGE B	Band edge beep (p. 63)
AP ON	Auto power ON (p. 63)
LOCK	Key lock effect (p. 63)
PTT LK	PTT lock (p. 64)
CONT	LCD Contrast (p. 64)
OPN.MSG	Opening message (p. 64)

Appears when expanded set mode 1 is ON.

EXP2 (Expanded set mode 2)

DTCS P	DTCS phase mode (p. 65)
LK OUT	Busy lockout (p. 65)
TOT	Time-out timer (p. 65)
ACTIVE	Active band (p. 65)
SPLIT	Split operation (p. 66)
NARROW	FM narrow deviation (p. 66)
MC SYN	Morse code synthesizer (p. 66)
KY SPD	Morse code keying speed (p. 66)

Appears when expanded set mode 2 is ON.

8 SET MODE

• Repeater tone (R TONE)

Selects the tone encoder frequency for accessing a repeater, etc. from one of 50 available tone frequencies.

- 67.0–254.1 Hz (50 tones):

88.5 Hz (default)

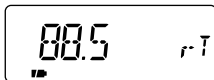

• Tone squelch/pocket beep frequency (C TONE)

Selects the tone squelch or pocket beep frequency from one of 50 available tone frequencies.

- 67.0–254.1 Hz (50 tones):

88.5 Hz (default)

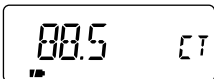

[Repeater/Tone squelch tone table]

67.0	82.5	100.0	123.0	151.4	171.3	189.9	210.7	250.3
69.3	85.4	103.5	127.3	156.7	173.8	192.8	218.1	254.1
71.9	88.5	107.2	131.8	159.8	177.3	196.6	225.7	
74.4	91.5	110.9	136.5	162.2	179.9	199.5	229.1	
77.0	94.8	114.8	141.3	165.5	183.5	203.5	233.6	
79.7	97.4	118.8	146.2	167.9	186.2	206.5	241.8	

• DTCS squelch code (CODE)

Selects the DTCS squelch code from one of 104 available codes.

- 023–754 (104 codes):

023 (default)

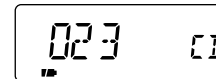

023	071	143	225	266	356	452	532	703
025	072	145	226	271	364	454	546	712
026	073	152	243	274	365	455	565	723
031	074	155	244	306	371	462	606	731
032	114	156	245	311	411	464	612	732
036	115	162	246	315	412	465	624	734
043	116	165	251	325	413	466	627	743
047	122	172	252	331	423	503	631	754
051	125	174	255	332	431	506	632	
053	131	205	261	343	432	516	654	
054	132	212	263	346	445	523	662	
065	134	223	265	351	446	526	664	

[DTCS code table]

• Offset frequency

(OFFSET)

Sets the offset frequency for duplex (repeater) operation within 0–159.995 MHz range.

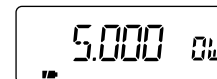

•Scan resume time (RESUME)

Selects the scan resume time of a paused frequency after the received signal disappears.

- 0 Scan resumes when a received signal disappears.
- 1–5 Scan pauses 1–5 sec. after a received signal disappears. (default: 2 sec.)
- Hold Scan pauses on a received signal even if it disappears. Rotate the tuning dial to resume manually.

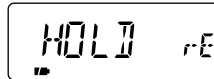

•Scan pause timer (PAUSE)

Selects the scan pause time. When receiving signals, the scan pauses according to the scan pause time.

- 2–20 Scan pauses for 2–20 sec. on a received signal in 2 sec. steps. (default: 10 sec.)
- Hold Scan pauses on a received signal until it disappears. Rotate the tuning dial to resume manually.

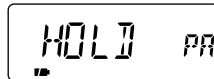
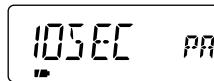

•Priority watch (PRIO)

Activates priority watch or priority watch with alert (BELL).

- OFF The priority watch is turned OFF. (default)
- ON The transceiver checks the memory channel frequency every 5 sec.
- BELL The transceiver checks the memory channel frequency every 5 sec. You can be alerted with beeps and a blinking “(•)”.

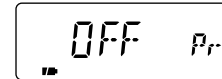

•Beep tone level (BEEP LV)

Adjusts the confirmation beep output level to the desired level within 32 levels or to the related level with volume.

- ▨ The confirmation beep (next item) must be turned on to have a beep tone.
- VOLUME The beep tone volume level is linked with the receive volume level. (default)
- The beep tone volume level can be set in 32 steps.

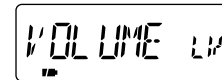

8 SET MODE

•Beep tone (BEEP)

Turns the confirmation beep ON or OFF.

- ON The confirmation beep is turned ON. (default)
- OFF The confirmation beep is turned OFF.

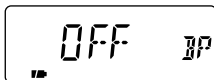
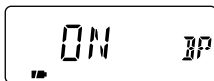

•Display backlighting (LIGHT)

The transceiver has display backlighting with a 5 sec. timer for nighttime operation. The display backlighting can be turned ON continuously or turned OFF, if desired.

/// “AUTO” setting turns the backlighting ON while operating with an external DC power source. (10–11.5 V DC)

- AUTO The display backlighting is ON with a 5 sec. timer. (default)
- ON The display backlighting is turned ON.
- OFF The display backlighting is turned OFF.

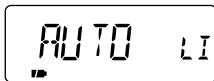

•Busy LED (BUSY)

The TX/RX indicator lights green while receiving a signal or when the squelch is open. This indication can be turned OFF to conserve the battery power, if desired.

- ON The indicator lights green while receiving a signal or when the squelch is open. (default)
- OFF The indicator does not function even if a signal is received.

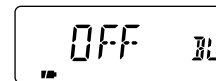
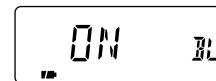

•Auto power OFF (AP OFF)

The transceiver can be set to automatically turn OFF after a specified period with a beep, when no switch is pushed.

120 min., 90 min., 60 min., 30 min. and OFF can be specified. The specified period is retained even when the transceiver is turned OFF by the auto power-off function. To cancel the function, select “OFF” in this set mode.

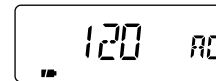
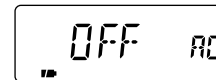

•Power save (P SAVE)

The power save function reduces the current drain to conserve battery power. This item sets the power save duty cycle—the ratio of receive circuit on to receive circuit off while standing by. The duty cycle can be set to automatic (default), 1:1, 1:4, 1:8, 1:16 or OFF.

“AUTO” selects “1:4” duty ratio when receiving no signal for 5 sec., then “1:8” 60 sec. after that.

When “AUTO” is selected, the power save automatically turns OFF while operating with an external DC power source (10–11.5 V DC)

For packet operation, the power save should be turned OFF to receive reliable packet data.

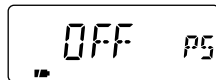
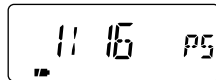
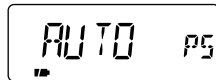

•Monitor switch action (MONI)

The monitor switch can be set as a ‘sticky’ switch. When set to the sticky condition, each push of [SQL] toggles the monitor function on and off.

- PUSH Set the monitor switch to normal. (default)
- HOLD Set the monitor switch to sticky switch.

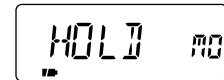
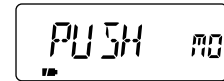

•Dial speed acceleration (SPEED)

The dial speed acceleration automatically speeds up the tuning dial speed when rotating the [DIAL] rapidly.

- ON The dial speed acceleration is turned ON. (default)
- OFF The dial speed acceleration is turned OFF.

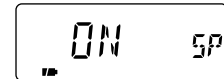

8 SET MODE

•Auto repeater (AUTORP)

The auto repeater function automatically turns ON or OFF the duplex operation with specified shift direction and tone encoder, when the operating frequency falls within or outside of the general repeater output frequency range.

U.S.A. version:

- ONLY Activates duplex only. (default)
- TONE Activates duplex and tone.
- OFF Deactivates the function.



Korea version:

- ON Activates duplex and tone. (default)
- OFF Deactivates the function.

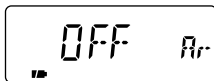

•DTMF speed (DTMF)

The rate at which DTMF memories send individual DTMF characters can be set to accommodate operating needs.

DISPLAY	INTERVAL	SPEED
100	100 msec.	5.0 cps
200	200 msec.	2.5 cps
300	300 msec.	1.6 cps
500	500 msec.	1.0 cps



cps=characters/sec.

•Optional HM-75A function (MIC)

Microphone simple mode is used to change the function assignments for switches on the optional HM-75A REMOTE CONTROL MICROPHONE.

•NORM-1: (default)

[A]	Selects band.
[B]	Toggles VFO and memory.
[▲]	[UP]
[▼]	[DOWN]

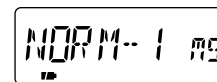

•NORM-2:

[A]	Toggles monitor function.
[B]	Toggles VFO and memory.
[▲]	[UP]
[▼]	[DOWN]

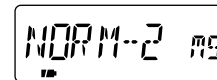

•SIMPLE:

[A]	Toggles monitor function.
[B]	Selects call channel C0.
[▲]	Selects memory Ch 000.
[▼]	Selects memory Ch 001.

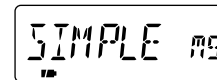

/// VFO mode cannot be selected via the microphone when
 /// SIMPLE mode is selected.

•Weather Alert (WX ALT)

(USA version only)

Turns the weather alert function ON or OFF.

- ON The WX alert beep sounds when an alert signal is received.
- OFF The WX alert beep does not sound. (default)

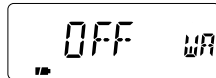

•Scan stop beep (STOPB)

Turns the scan stop beep ON or OFF.

•Turn the expanded set mode 1 ON in advance.

- ON The scan stop beep sounds when a scan is stopped.
- OFF The scan stop beep does not sound even when a scan is stopped. (default)

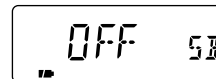

•Scan stop LED (STOP L)

Turns the scan stop LED ON or OFF.

•Turn the expanded set mode 1 ON in advance.

- ON The keypad backlighting blinks in green and orange when a scan is stopped.
- OFF The keypad backlighting does not blink even when a scan is stopped. (default)



•Backlighting position (LIGHTP)

Selects the lighted area from keypad only, function display only and both keypad and function display.

•Turn the expanded set mode 1 ON in advance.

- ALL Lighted area is both keypad and function display. (default)
- KEY Lighted area is keypad only.
- LCD Lighted area is function display only.

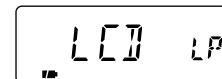
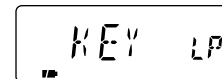
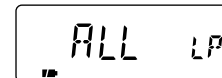

8 SET MODE

•Backlighting color (COLOR)

Selects the backlighting color between green, orange or red.

•Turn the expanded set mode 1 ON in advance.

•GREEN Green backlighting color.
(default)

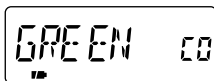

•ORANGE Orange backlighting color.



•RED Red backlighting color.

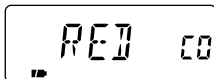

•Band edge beep (EDGE B)

Turns the band edge beep ON or OFF. The band edge beep sounds when the operating frequency changes across the band edge.

•Turn the expanded set mode 1 ON in advance.

•ON The band edge beep is turned ON.

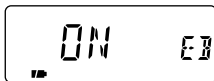

•OFF The band edge beep is turned OFF. (default)

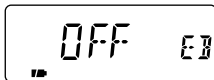

•Auto power ON (AP ON)

Turns the transceiver power ON after 30 min. to 24 hrs. in 30 min. steps.

•Turn the expanded set mode 1 ON in advance.

When operating with battery pack or case and the battery is exhausted, auto power-on does not function.

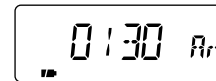
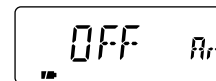

•Key lock effect (LOCK)

While the lock function is ON, [PWR], [PTT], [SQL], [▲]/[▼] and [CALL/TV LOCK] can still be accessed. Accessible switches can be set to 1 of 4 groups.

•Turn the expanded set mode 1 ON in advance.

•NORMAL [PWR], [PTT], [SQL] and [▲]/[▼] are accessible.



•NO SQL [PWR], [PTT] and [SQL] are accessible.

•NO VOL [PWR], [PTT] and [▲]/[▼] are accessible.



•ALL [PWR] and [PTT] are accessible.

•PTT lock

(PTT LK)

Turns the PTT lock ON or OFF.

- Turn the expanded set mode 1 ON in advance.

- ON The PTT lock is turned ON.
- OFF The PTT lock is turned OFF.
(default)

**•Opening message**

(OPN.MSG)

Turns the opening message ON or OFF.

- Turn the expanded set mode 1 ON in advance.

- ON Displays the opening message at power ON. (default)
- OFF Does not display the opening message at power ON.

**•LCD contrast**

(CONT)

The contrast of the LCD can be adjusted from 4 levels.

- Turn the expanded set mode 1 ON in advance.

- 1 (low contrast) – 4 (high contrast)
3 (default)

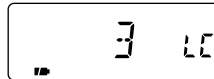

8 SET MODE

•DTCS phase mode (DTCS P)

Selects the DTCS phase mode.

- Turn the expanded set mode 2 ON in advance.

- BOTH N Normal phases are used for both Tx and Rx. (default)

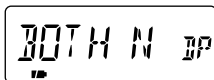

- TN-RR Normal phase is used for Tx; Reverse phase for Rx.

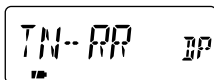

- TR-RN Reverse phase is used for Tx; Normal phase for Rx.



- BOTH R Reverse phases are used for both Tx and Rx.

•Busy lockout (LK OUT)

Turns the busy lockout function ON and OFF. This function inhibits transmission while receiving a signal or when the squelch is open.

- Turn the expanded set mode 2 ON in advance.

- ON The busy lockout is turned ON.

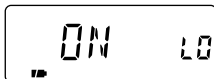

- OFF The busy lockout is turned OFF. (default)

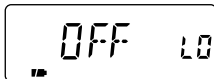

•Time-out timer (TOT)

To prevent accidental prolonged transmission, etc., the transceiver has a time-out timer. This timer cuts a transmission OFF after 1, 3, 5 or 10 min. of continuous transmission. This timer can be cancelled.

- Turn the expanded set mode 2 ON in advance.

Approx. 10 sec. before the time-out timer is activated, the transceiver emits a beep tone as a warning.

- OFF The time-out timer is turned OFF. (default)



- 1-10 The transmission is cut OFF after the set period elapses.

•Active band (ACTIVE)

Allows continuous frequency selection of the operating frequency across all bands.

- ALL The operating frequency can be selected continuously. (default)

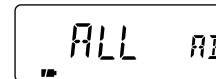

- SINGLE The operating frequency can be selected within the current band. Push [BAND] for band selection in this case.

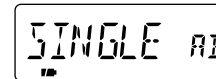

•Split operation (SPLIT)

Turns the split operation ON or OFF. Split frequency operation allows you to transmit and receive on two different frequencies. Split frequency operation uses 2 frequencies, one in VFO A and the other in VFO B.

•Turn the expanded set mode 2 ON in advance.

•ON The split operation is turned ON. 'SPA' appears for VFO A; 'SPB' appears for VFO B.



•OFF The split operation is turned OFF. (default)



•FM narrow deviation (NARROW)

Selects the maximum FM deviation for normal or narrow on transmit mode.

•ON Selects the narrow FM deviation for FM mode.



•OFF Selects the normal FM deviation for FM mode. (default)



•Morse code synthesizer (MC SYN)

The transceiver announces the operating frequency or TV channel number in Morse code.

•Turn the expanded set mode 2 ON in advance.

•ON The Morse code synthesizer is turned ON.



•OFF The Morse code synthesizer is turned OFF. (default)



Turning power ON while pushing [CALL/TV] also toggles the Morse code synthesizer ON or OFF.

•Morse code keying speed (KY SPD)

The keying speed of the Morse code synthesizer can be adjusted within 10 to 25 WPM for your convenience.

•Turn the expanded set mode 2 ON in advance.

•10–25 WPM in 5 WPM steps
20 WPM (default)

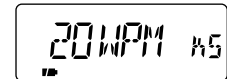

■ Programming a DTMF code

DTMF codes are used for autopatching, accessing repeaters, controlling other equipment, etc. The transceiver has 10 DTMF memory channels (D0–D9) for storage of often-used DTMF codes of up to 16 digits.

- ① Push [• DTMF.M] for 1 sec. to enter DTMF memory.
- ② Rotate [DIAL] to select the desired DTMF memory channel.
 - “T-CALL” appears when a 1750 Hz tone burst signal is selected. (p. 34)

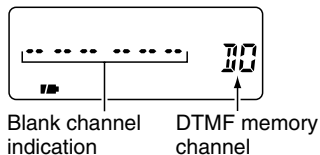

- ③ Push [• DTMF.M] for 1 sec. to enter programming mode.
 - Previously programmed DTMF code is cleared.

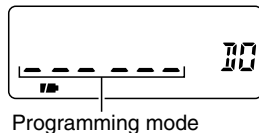

- ④ Push the desired keys to input the characters.
 - [VFO] inputs “A,”[MR] inputs “B,”[CALL/TV] inputs “C,”[BAND] inputs “D,”[•] inputs “*” (E) and [MODE] inputs “F” (#).
 - Up to 16 digits can be programmed.
- ⑤ Repeat ④ until the desired code is input.

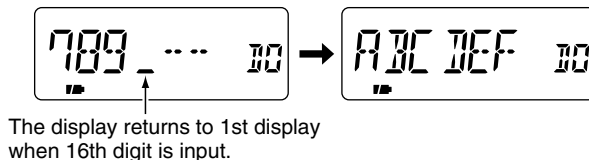
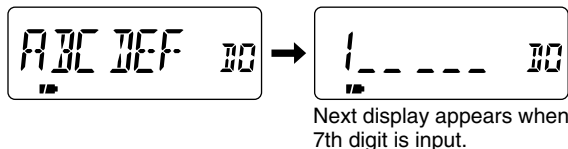

- ⑥ Push [SQL] or [PTT] to program the DTMF code and exit programming mode.
 - Entering 16th digit automatically exits the programming mode.

■ Transmitting a DTMF code

◇ Transmitting from DTMF memory

The selected DTMF code is transmitted at each push of the [SQL] switch while transmitting.

/// The rate at which DTMF memories send individual DTMF characters can be set in set mode. (p. 61)

- ① Set the desired frequency.
- ② Push [• DTMF.M] for 1 sec. to enter DTMF memory.
- ③ Rotate [DIAL] to select the desired DTMF memory channel.
- ④ Push [VFO] to exit DTMF memory.
- ⑤ While pushing [PTT], push [SQL] to transmit the selected DTMF code.

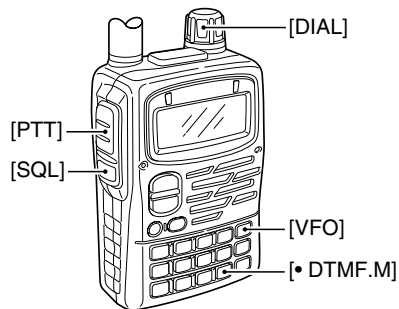

DTMF code is displayed
6 digits at a time.



◇ Transmitting a DTMF code directly

DTMF code can be transmitted via keypad directly while transmitting.

- ① Set the desired frequency.
- ② While pushing [PTT], push the desired keys to transmit the DTMF code.
 - [VFO] transmits "A," [MR] transmits "B," [CALL/TV] transmits "C," [BAND] transmits "D," [•] transmits "E" (*) and [MODE] transmits "F" (#).

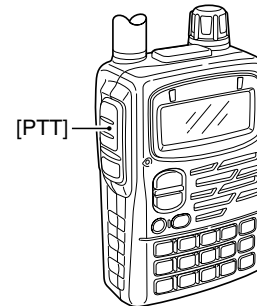

DTMF code is not displayed.

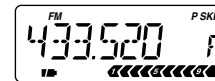

■ Clearing a DTMF memory

An unwanted DTMF memory can be cleared (erased).

- ① Push [**• DTMF.M**] for 1 sec. to enter DTMF memory mode.
- ② Rotate [**DIAL**] to select the desired DTMF memory channel to be cleared.
- ③ Push [**• DTMF.M**] for 1 sec. to enter programming mode and clear the selected DTMF memory channel.
 - The DTMF memory channel is cleared.
- ④ Push [**SQL**] or [**PTT**] to exit programming mode.

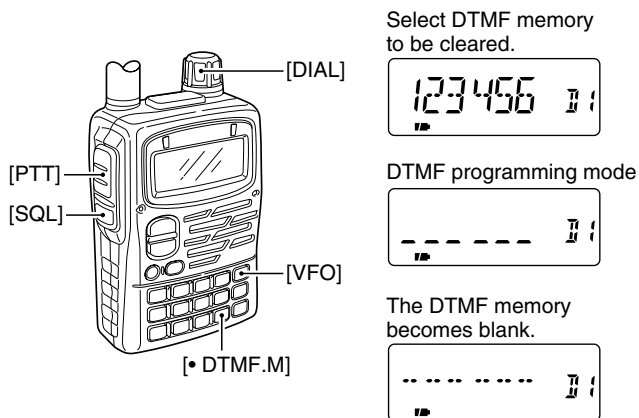

■ Confirming a DTMF memory

The DTMF memory can be confirmed with a DTMF tone.

- ① Push [**• DTMF.M**] for 1 sec. to enter DTMF memory mode.
- ② Rotate [**DIAL**] to select the desired DTMF memory channel.
- ③ Push [**SQL**] to confirm the DTMF memory contents.
 - The display returns to frequency indication after confirmation.

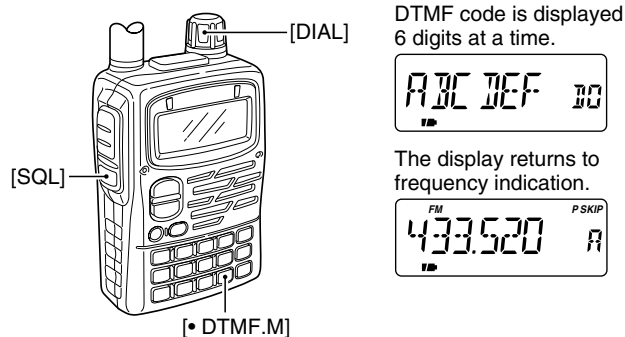

■ Tone frequency and DTCS code

•Subaudible (repeater) tone

Some repeaters require subaudible tones to be accessed. Subaudible tones are superimposed over your normal signal and must be set in advance.

•Tone and DTCS squelches

The tone squelch (CTCSS) or DTCS squelch opens only when receiving a signal containing a matching subaudible tone or DTCS code, respectively. You can silently wait for calls from group members using the same tone or code. Separate tone frequencies and tone squelch/pocket beep operation.

•Pocket and DTCS beep

These functions use subaudible tones or DTCS codes for calling and can be used as a “common pager” to inform you that someone has called while you were away from the transceiver. The same code is used for DTCS squelch and beep.

◇ Setting subaudible tones for repeater or tone squelch

- ① Push [8 SET] for 1 sec. to enter set mode.
- ② Rotate [DIAL] until “R TONE” (repeater tone) or “C TONE” (CTCSS tone) appears.



- ③ Push [8 SET].
- ④ Rotate [DIAL] to select the desired repeater or CTCSS tone.
 - Each operating band and each memory channel have independent settings.

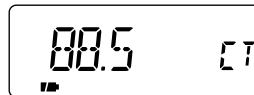

- ⑤ Push [VFO] to exit set mode.

◇ Setting DTCS code for DTCS squelch or beep

- ① Push [8 SET] for 1 sec. to enter set mode.
- ② Rotate [DIAL] until “CODE” appears.

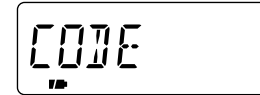

- ③ Push [8 SET].
- ④ Rotate [DIAL] to select the desired DTCS code.
 - Each operating band and each memory channel have independent settings.

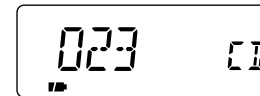

- ⑤ Push [VFO] to exit set mode.

▨ DTCS phase mode can be selected in expanded set mode 2. (p. 65)

9 OTHER FUNCTIONS

■ Tone/DTCS squelch

- ① Set the desired operating frequency, CTCSS tone and DTCS code.
- ② Push [2 TONE] for 1 sec. one or more times to activate the tone or DTCS squelch. (T SQL or DTCS)
 - Subaudible tone encoder “T,” tone squelch “T SQL,” pocket beep “T SQL ((•)),” DTCS squelch “DTCS,” DTCS beep “((•)) DTCS” and no tone operation are activated in order.
 - Rotating [DIAL] while pushing [2 TONE] also selects the tone functions.
- ③ Operate the transceiver in the normal way.
- ④ When the received signal includes a matching tone, the squelch opens and the signal can be heard.
 - When the received signal’s tone does not match, tone squelch does not open, however, the S-indicator shows signal strength.
 - To open the squelch manually, push and hold [SQL].

No tone operation

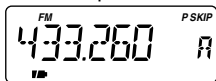

Pocket beep

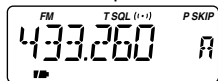

Subaudible tone encoder

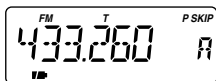

DTCS squelch

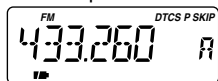

Tone squelch

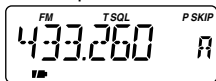

DTCS beep

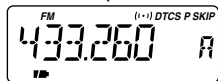

■ Pocket beep function

- ① Set the desired operating frequency.
- ② Set the desired CTCSS tone or DTCS code.
- ③ Push [2 TONE] for 1 sec. one or more times to activate the pocket beep or DTCS beep. (T SQL ((•)) or ((•)) DTCS)
 - Rotating [DIAL] while pushing [2 TONE] also selects the tone functions.

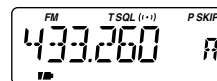

Pocket beep
by CTCSS code

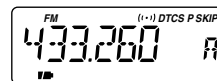

Pocket beep
by DTCS code

- ④ When a signal with the correct tone or code is received, the transceiver emits beep tones for 30 sec. and blinks “((•))”.
- ⑤ Push [PTT] to answer or push [SQL] to stop the beeps and blinking.

▷ CONVENIENT

Store subaudible tone frequencies, DTCS code, DTCS phase mode and tone/DTCS squelch ON/OFF settings in memories (call) for easy recall.

■ Available tone frequencies

The transceiver has 50 tone frequencies for repeater and tone squelch (CTCSS)/pocket beep operation. Separate tone frequencies can be set for repeater and tone squelch/pocket beep operation.

(unit: Hz)

67.0	82.5	100.0	123.0	151.4	171.3	189.9	210.7	250.3
69.3	85.4	103.5	127.3	156.7	173.8	192.8	218.1	254.1
71.9	88.5	107.2	131.8	159.8	177.3	196.6	225.7	
74.4	91.5	110.9	136.5	162.2	179.9	199.5	229.1	
77.0	94.8	114.8	141.3	165.5	183.5	203.5	233.6	
79.7	97.4	118.8	146.2	167.9	186.2	206.5	241.8	

/// The transceiver has 50 tone frequencies and consequently their spacing is narrow compared with units having 38 tones. Therefore, some tone frequencies may receive interference from adjacent tone frequencies.

■ Available DTCS codes

The transceiver has 104 DTCS codes for DTCS squelch and DTCS beep.

023	071	143	225	266	356	452	532	703
025	072	145	226	271	364	454	546	712
026	073	152	243	274	365	455	565	723
031	074	155	244	306	371	462	606	731
032	114	156	245	311	411	464	612	732
036	115	162	246	315	412	465	624	734
043	116	165	251	325	413	466	627	743
047	122	172	252	331	423	503	631	754
051	125	174	255	332	431	506	632	
053	131	205	261	343	432	516	654	
054	132	212	263	346	445	523	662	
065	134	223	265	351	446	526	664	

9 OTHER FUNCTIONS

■ Tone scan

The transceiver can detect the subaudible tone frequency and DTCS code in a received signal. By monitoring a signal that is being transmitted on a repeater input frequency, you can determine the tone frequency required to access the repeater.

- ① Set the desired frequency or memory channel to be checked for a tone frequency or DTCS code.
- ② Push [2 TONE] for 1 sec. one or more times to activate the repeater tone, tone squelch or DTCS squelch. (T, T SQL or DTCS)
 - Rotating [DIAL] while pushing [2 TONE] also selects the tone functions.
- ③ Push [7 T.SCAN] for 1 sec. to start the tone scan.
 - To change the scanning direction, rotate [DIAL].
- ④ When the tone frequency or DTCS code is decoded, the set mode contents are programmed with the frequency or code.
 - The tone scan pauses approx. 10 sec. when a tone frequency or DTCS code is detected.
 - The decoded tone frequency is used for the repeater tone frequency when the tone squelch or DTCS squelch is OFF.
 - The decoded tone frequency is used for the tone squelch frequency when the tone squelch is ON.
 - The decoded DTCS code is used for the DTCS code when the DTCS squelch is ON.
 - “CT,” “rT” or “CD” appears according to the tone setting.

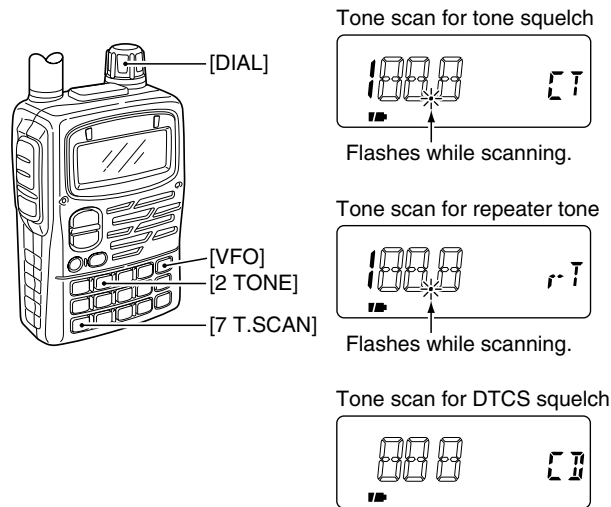

- ⑤ Push [VFO] to stop the scan.
 - If the scan is cancelled before the transceiver detects the tone or code, the set mode contents are not changed.

■ Beep tones

You can select to have confirmation beeps sound at the push of a switch. The output level can be adjusted within 32 levels or to the related level of the volume. (p. 58)

You can select silent operation by turning beep tones OFF. (p. 59)

These can be selected in set mode.

■ Dial speed acceleration

The dial speed acceleration automatically speeds up the tuning dial speed when rotating the [DIAL] rapidly.

This function can be turned ON and OFF in set mode. (p. 60)

■ Lock function

The lock function prevents accidental frequency changes and accidental function access.

- ➔ Push [CALL/TV LOCK] for 1 sec. to toggle the lock function ON and OFF.
 - [PWR], [VOL], [SQL] and [PTT] can still be accessed while the lock function is ON. (default)

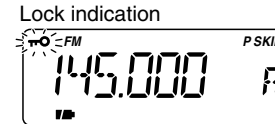

◇ Key lock effect

While the lock function is ON, [PWR], [VOL], [SQL] and [PTT] can still be accessed. Accessible switches can be set to 1 of 4 groups in expanded set mode 1. (p. 63)

- “NORMAL” : [PWR], [VOL], [SQL] and [PTT] are accessible.
- “NO SQL” : [PWR], [SQL] and [PTT] are accessible.
- “NO VOL” : [PWR], [VOL] and [PTT] are accessible.
- “ALL” : [PWR] and [PTT] are accessible.

9 OTHER FUNCTIONS

■ Morse code synthesizer

The transceiver announces the operating frequency or TV channel number in Morse code. The keying speed can be adjusted within 10 to 25 WPM in 5 WPM steps for your convenience. This can be selected in expanded set mode 2. (p. 66)

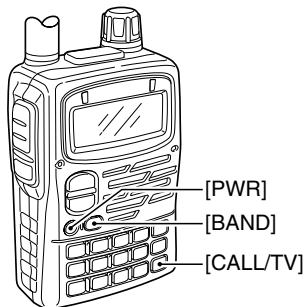

➔ Push [BAND] for 1 sec. for frequency announcement when the Morse code synthesizer is turned ON.

▨ Turning power ON while pushing [CALL/TV] also toggles the Morse code synthesizer ON or OFF.

■ Power save

The power save function reduces the current drain to conserve battery power.

The power save duty cycle, the ratio of receive circuit on to receive circuit off while standing by, can be set to automatic (default), 1:1, 1:4, 1:8, 1:16 or OFF in set mode. (p. 60)

•“AUTO” selects “1:4” duty ratio when receiving no signal for 5 sec., then “1:8” 60 sec. after that.

▨ When automatic is selected, the power save automatically turns OFF while operating with an external DC power supply. (11.0 V DC \pm 5%)

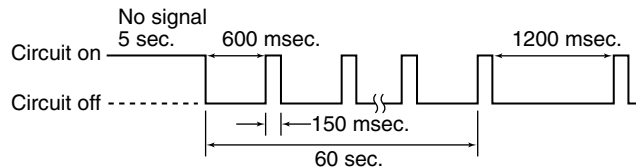

■ Time-out timer

To prevent accidental prolonged transmission, etc., the transceiver has a time-out timer. This timer cuts a transmission OFF after 1, 3, 5 or 10 min. of continuous transmission. This timer can be cancelled (default).

/// Approx. 10 sec. before the time-out timer is activated, the transceiver emits a beep tone as a warning.

This can be selected in expanded set mode 2. (p. 65)

■ PTT lock

To prevent accidental transmission, etc., the transceiver has a PTT lock function.

This can be selected in expanded set mode 1. (p. 64)

■ Auto power OFF

The transceiver can be set to automatically turn OFF after a specified period with a beep when no switch is pushed.

120 min., 90 min., 60 min., 30 min. and OFF can be specified. The specified period is retained even when the transceiver is turned OFF by the auto power-off function. To cancel the function, select "OFF" in the auto power-off item in set mode.

This can be selected in set mode. (p. 59)

■ Auto power ON

The transceiver can be set to automatically turn ON after a specified period. The timer can be selected within 30 min. to 24 hrs. in 30 min. steps.

This can be selected in expanded set mode 1. (p. 63)

/// When operating with battery pack or case and the battery is exhausted, auto power-on does not function.

9 OTHER FUNCTIONS

■ Weather channel operation

(USA version only)

There are 10 weather channels for monitoring weather channels from the NOAA (National Oceanographic and Atmospheric Administration) broadcasts.



◆ Weather channel selection

- ① Push [CALL/TV LOCK] one or two times to select weather channel mode.
 - “WX” and the weather channel number appear.
- ② Rotate [DIAL] to select the desired weather channel.
- ① Push [VFO] or [MR] to return to the previous frequency.

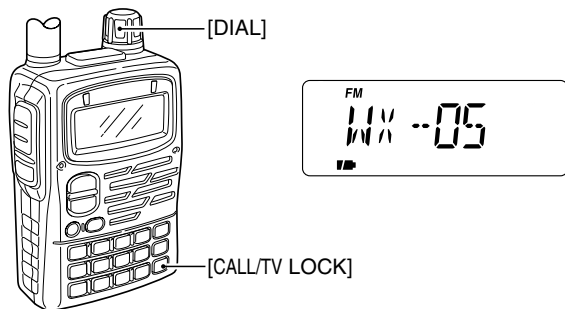

◆ Weather alert function

NOAA broadcast stations transmit weather alert tones before important weather announcements. When the weather alert function is turned ON, the selected weather channel is monitored every 5 sec. for the announcement. When the alert signal is detected, the “AL.T” and the WX channel are displayed alternately and sounds a beep tone until the transceiver is operated. The previously selected (used) weather channel is checked periodically during standby or while scanning.

- ① Select the desired weather channel.
- ② Turn the weather alert function ON in set mode.
 - Push [8 SET] for 1 sec. to enter set mode.
 - Rotate [DIAL] to select the [WX ALT] (weather alert function), then push [8 SET].
 - Rotate the [DIAL] to set ON.
 - Push [VFO] to exit set mode.
- ③ Set the desired stand-by condition.
 - Select VFO, memory or call channel.
 - Scan or priority watch operation can also be selected.
- ④ When the alert is detected, a beep sounds and the following indication will be displayed.

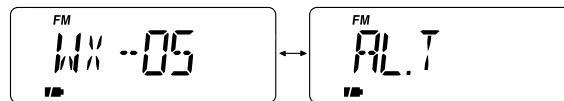

Shows above indications alternately.

- ⑤ Turn the weather alert function OFF in set mode.

NOTE: While receiving a signal (on a frequency other than the weather alert ON frequency), the receiving signal or audio will be interrupted momentarily every 5 sec. (approx.) in the case that the alert function is turned ON. This symptom is caused by the WX alert function. To cancel these symptoms, set the weather alert item OFF in set mode.

9 OTHER FUNCTIONS

■ Cloning function

The IC-T90A has transceiver-to-transceiver data cloning capability. This function is useful when you want to copy all of the programmed contents from one IC-T90A to another.

• An optional OPC-474 CLONING CABLE is required.

- 1 Connect an optional OPC-474 between both [SP] jacks.
- 2 While pushing [8 SET] and [MR], push [PWR] for 1 sec. to enter cloning mode.
 - “CLONE” appears.
- 3 Push [PTT] on the “master” transceiver.
 - “CL OUT” appears and the signal indicator shows that cloning is taking place.
- 4 Push [PWR] for 1 sec. to turn power OFF.

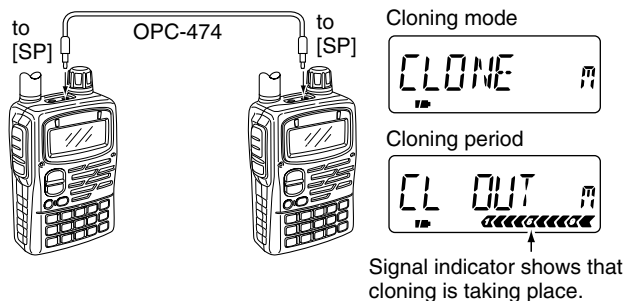

The optional CS-T90A CLONING SOFTWARE and the optional OPC-478 CLONING CABLE are available to clone and edit contents with a PC (for Microsoft® Windows® 95/98/ME).

Microsoft® and Windows® are registered trademarks of Microsoft Corporation in the U.S.A. and other countries.

■ [SP/MIC] jacks

To connect external equipment such as speaker, microphone, TNC, etc. refer to the diagram below.

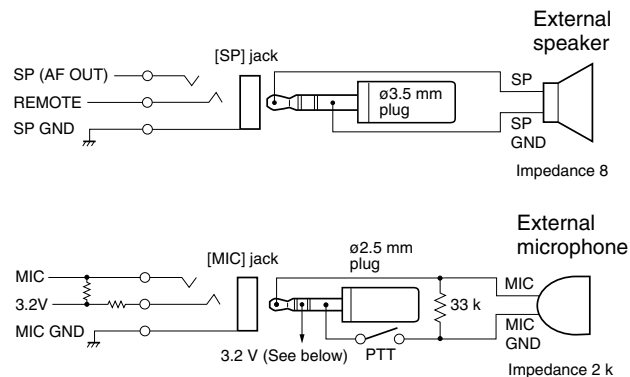

▨ The center terminal of [MIC] outputs 3.2 V DC via 330 register.

Resetting

The function display may occasionally display erroneous information (e.g. when first applying power). This may be caused externally by static electricity or by other factors.

If this problem occurs, turn power OFF. After waiting a few seconds, turn power ON again. If the problem persists, perform either or both procedures below.

• All reset

Reset the CPU before operating the transceiver for the first time, or when the internal CPU malfunctions to clear and return all programmed contents to their default settings.

• Partial reset

If you want to initialize the operating conditions (VFO frequency, VFO settings, set mode contents) without clearing the memory contents, a partial resetting function is available for the transceiver.

◇ All reset

- ① Push [POWER] for 2 sec. to turn power OFF.
 - ② While pushing [BAND], [VFO] and [MR], turn power ON to reset the CPU.
- “CLEAR” appears when resetting the CPU.

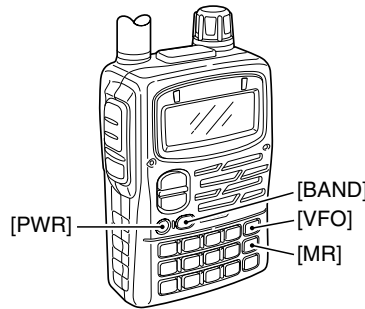

CAUTION: Resetting the CPU returns all programmed contents to their default settings.

◇ Partial reset

- ① Push [POWER] for 2 sec. to turn power OFF.
- ② While pushing [VFO], turn power ON to partially reset the transceiver.

• All resetting

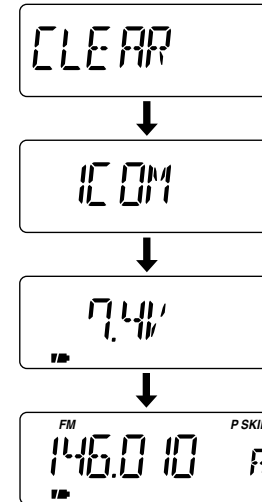

The optional HM-75A allows you to remotely select operating frequencies, memory channels, etc.

Remote control functions can be selected from 3 settings. These can be selected in set mode. (p. 61)

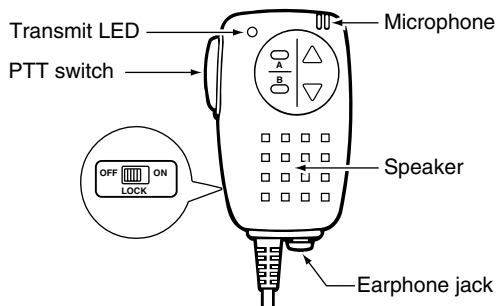

The HM-75A has a lock switch on the backside to prevent accidental frequency changes, etc.

Be sure to turn power OFF when plugging the HM-75A in the [SP/MIC] jacks.

•NORM-1: (default)

[A]	Selects band.
[B]	Toggles VFO and memory.
[▲]	[UP]
[▼]	[DOWN]

•NORM-2:

[A]	Toggles monitor function.
[B]	Toggles VFO and memory.
[▲]	[UP]
[▼]	[DOWN]

•SIMPLE:

[A]	Toggles monitor function.
[B]	Selects call channel C0.
[▲]	Selects memory Ch 000.
[▼]	Selects memory Ch 001.

VFO mode cannot be selected via the microphone when SIMPLE mode is selected.

SIMPLE mode can select only 3 channels and is useful for group operations during touring, etc.

TROUBLESHOOTING 11

If your transceiver seems to be malfunctioning, please check the following points before sending it to a service center.

PROBLEM	POSSIBLE CAUSE	SOLUTION	REF.
No power comes ON.	<ul style="list-style-type: none"> •The batteries are exhausted. •The battery polarity is reversed. 	<ul style="list-style-type: none"> •Replace the batteries or charge the battery pack. •Check the battery polarity. 	pgs. 1, 14 p. 1
No sound comes from the speaker.	<ul style="list-style-type: none"> •Volume level is too low. •Different tone is selected with tone/DTCS squelch. 	<ul style="list-style-type: none"> •Push [▲] to a suitable level. •Check the tone using tone/DTCS scan. 	p. 17 p. 70
Transmitting is impossible.	<ul style="list-style-type: none"> •The batteries are exhausted. •A frequency outside of the 50/144/440 MHz amateur bands is set. 	<ul style="list-style-type: none"> •Replace the batteries or charge the battery pack. •Reset the frequency within the 50/144/440 MHz amateur bands. 	pgs. 13, 14 p. 19
No contact possible with another station.	<ul style="list-style-type: none"> •Different tone is selected with tone/DTCS squelch. 	<ul style="list-style-type: none"> •Check the tone using tone scan. 	p. 70
Tuning dial or [▼]/[▲] function is strange.	<ul style="list-style-type: none"> •Tuning dial and [▼]/[▲] functions are exchanged. 	<ul style="list-style-type: none"> •Push [1 V↔D] for 1 sec. to cancel the function. 	p. 23
Frequency cannot be set.	<ul style="list-style-type: none"> •The lock function is activated. •Memory or call channel is selected. 	<ul style="list-style-type: none"> •Push [CALL/TV LOCK] for 1 sec. to cancel the function. •Push [VFO] to select VFO mode. 	p. 74 p. 20
No beeps sound.	<ul style="list-style-type: none"> •Beep tones are turned OFF or the beep tone level is low. 	<ul style="list-style-type: none"> •Turn beep tones ON or set the beep tone level to appropriate level in set mode. 	pgs. 58, 59
Receive audio is distorted.	<ul style="list-style-type: none"> •The operating mode is not selected correctly. 	<ul style="list-style-type: none"> •Select a suitable operating mode in set mode. 	p. 21
Desired set mode item cannot be selected.	<ul style="list-style-type: none"> •The desired set mode item is in expanded set mode 1 or 2. •Some set mode items can be selected from VFO or memory mode only. 	<ul style="list-style-type: none"> •Turn the expanded set mode 1 or 2 ON. •Enter set mode from appropriate operating mode. 	p. 55 pgs. 17, 18 22, 27



12 TV FREQUENCY TABLE

The following tables show the channels versus video and audio frequencies depending on each version.

■ U.S.A. channels

CH	Video	Audio	CH	Video	Audio
2	55.25	59.75	26	543.25	547.75
3	61.25	65.75	27	549.25	553.75
4	67.25	71.75	28	555.25	559.75
5	77.25	81.75	29	561.25	565.75
6	83.25	87.75	30	567.25	571.75
7	175.25	179.75	31	573.25	577.75
8	181.25	185.75	32	579.25	583.75
9	187.25	191.75	33	585.25	589.75
10	193.25	197.75	34	591.25	595.75
11	199.25	203.75	35	597.25	601.75
12	205.25	209.75	36	603.25	607.75
13	211.25	215.75	37	609.25	613.75
14	471.25	475.75	38	615.25	619.75
15	477.25	481.75	39	621.25	625.75
16	483.25	487.75	40	627.25	631.75
17	489.25	493.75	41	633.25	637.75
18	495.25	499.75	42	639.25	643.75
19	501.25	505.75	43	645.25	649.75
20	507.25	511.75	44	651.25	655.75
21	513.25	517.75	45	657.25	661.75
22	519.25	523.75	46	663.25	667.75
23	525.25	529.75	47	669.25	673.75
24	531.25	535.75	48	675.25	679.75
25	537.25	541.75	49	681.25	685.75

■ CCIR channels

CH	Video	Audio	CH	Video	Audio
1	41.25	46.75	31	551.25	556.75
2	48.25	53.75	32	559.25	564.75
3	55.25	60.75	33	567.25	572.75
4	62.25	67.75	34	575.25	580.75
5	175.25	180.75	35	583.25	588.75
6	182.25	187.75	36	591.25	596.75
7	189.25	194.75	37	599.25	604.75
8	196.25	201.75	38	607.25	612.75
9	203.25	208.75	39	615.25	620.75
10	210.25	215.75	40	623.25	628.75
11	217.25	222.75	41	631.25	636.75
12	224.25	229.75	42	639.25	644.75
21	471.25	476.75	43	647.25	652.75
22	479.25	484.75	44	655.25	660.75
23	487.25	492.75	45	663.25	668.75
24	495.25	500.75	46	671.25	676.75
25	503.25	508.75	47	679.25	684.75
26	511.25	516.75	48	687.25	692.75
27	519.25	524.75	49	695.25	700.75
28	527.25	532.75	50	703.25	708.75
29	535.25	540.75	51	711.25	716.75
30	543.25	548.75	52	719.25	724.75

■ Australian channels

CH	Video	Audio
53	727.25	732.75
54	735.25	740.75
55	743.25	748.75
56	751.25	756.75
57	759.25	764.75
58	767.25	772.75
59	775.25	780.75
60	783.25	788.75
61	791.25	796.75
62	799.25	804.75
63	807.25	812.75
64	815.25	820.75
65	823.25	828.75
66	831.25	836.75
67	839.25	844.75
68	847.25	852.75
69	855.25	860.75

CH	Video	Audio
0	46.25	51.75
1	57.25	62.75
2	64.25	69.75
3	86.25	91.75
4	95.25	100.75
5	102.25	107.75
5A	138.25	143.75
6	175.25	180.75
7	182.25	187.75
8	189.25	194.75
9	196.25	201.75
10	209.25	214.75
11	216.25	221.75
28	527.25	532.75
29	534.25	539.75
30	541.25	546.75
31	548.25	553.75
32	555.25	560.75
33	562.25	567.75
34	569.25	574.75
35	576.25	581.75
36	583.25	588.75
37	590.25	595.75
38	597.25	602.75

CH	Video	Audio
39	604.25	609.75
40	611.25	616.75
41	618.25	623.75
42	625.25	630.75
43	632.25	637.75
44	639.25	644.75
45	646.25	651.75
46	653.25	658.75
47	660.25	665.75
48	667.25	672.75
49	674.25	679.75
50	681.25	686.75
51	688.25	693.75
52	695.25	700.75
53	702.25	707.75
54	709.25	714.75
55	716.25	721.75
56	723.25	728.75
57	730.25	735.75
58	737.25	742.75
59	744.25	749.75
60	751.25	756.75
61	758.25	763.75
62	765.25	770.75

CH	Video	Audio
63	772.25	777.75
64	779.25	784.75
65	786.25	791.75
66	793.25	798.75
67	800.25	805.75
68	807.25	812.75
69	814.25	819.75

■ Taiwan channels

CH	Video	Audio
7	175.25	179.75
8	181.25	185.75
9	187.25	191.75
10	193.25	197.75
11	199.25	203.75
12	205.25	209.75

■ New Zealand channels

CH	Video	Audio
1	45.25	50.75
2	55.25	60.75
3	62.25	67.75
4	175.25	180.75
5	182.25	187.75
6	189.25	194.75
7	196.25	201.75
8	203.25	208.75
9	210.25	215.75
10	217.25	222.75
11	224.25	229.75

12 TV FREQUENCY TABLE

■ China channels

CH	Video	Audio	CH	Video	Audio
1	49.75	56.25	28	631.25	637.75
2	57.75	64.25	29	639.25	645.75
3	65.75	72.25	30	647.25	653.75
4	77.25	83.75	31	655.25	661.75
5	85.25	91.75	32	663.25	669.75
6	168.25	174.75	33	671.25	677.75
7	176.25	182.75	34	679.25	685.75
8	184.25	190.75	35	687.25	693.75
9	192.25	198.75	36	695.25	701.75
10	200.25	206.75	37	703.25	709.75
11	208.25	214.75	38	711.25	717.75
12	216.25	222.75	39	719.25	725.75
13	471.25	477.75	40	727.25	733.75
14	479.25	485.75	41	735.25	741.75
15	487.25	493.75	42	743.25	749.75
16	495.25	501.75	43	751.25	757.75
17	503.25	509.75	44	759.25	765.75
18	511.25	517.75	45	767.25	773.75
19	519.25	525.75	46	775.25	781.75
20	527.25	533.75	47	783.25	789.75
21	535.25	541.75	48	791.25	797.75
22	543.25	549.75	49	799.25	805.75
23	551.25	557.75	50	807.25	813.75
24	559.25	565.75	51	815.25	821.75
25	607.25	613.75	52	823.25	829.75
26	615.25	621.75	53	831.25	837.75
27	623.25	629.75	54	839.25	845.75

■ Indonesian channels

CH	Video	Audio	CH	Video	Audio
2	48.25	53.75	38	607.25	612.75
3	55.25	60.75	39	615.25	620.75
4	62.25	67.75	40	623.25	628.75
5	175.25	180.75	41	631.25	636.75
6	182.25	187.75	42	639.25	644.75
7	189.25	194.75	43	647.25	652.75
8	196.25	201.75	44	655.25	660.75
9	203.25	208.75	45	663.25	668.75
10	210.25	215.75	46	671.25	676.75
11	217.25	222.75	47	679.25	684.75
21	471.25	476.75	48	687.25	692.75
22	479.25	484.75	49	695.25	700.75
23	487.25	492.75	50	703.25	708.75
24	495.25	500.75	51	711.25	716.75
25	503.25	508.75	52	719.25	724.75
26	511.25	516.75	53	727.25	732.75
27	519.25	524.75	54	735.25	740.75
28	527.25	532.75	55	743.25	748.75
29	535.25	540.75	56	751.25	756.75
30	543.25	548.75	57	759.25	764.75
31	551.25	556.75	58	767.25	772.75
32	559.25	564.75	59	775.25	780.75
33	567.25	572.75	60	783.25	788.75
34	575.25	580.75	61	791.25	796.75
35	583.25	588.75	62	799.25	804.75
36	591.25	596.75	63	807.25	812.75
37	599.25	604.75	64	815.25	820.75

■ Italian channels

CH	Video	Audio
65	823.25	828.75
66	831.25	836.75
67	839.25	844.75
68	847.25	852.75
69	855.25	860.75

CH	Video	Audio
A	53.75	59.25
B	62.25	67.75
C	82.25	87.75
D	175.25	180.75
E	183.25	188.75
F	192.25	197.75
G	201.25	206.75
H	210.25	215.75
H1	217.25	222.75
H2	224.25	229.75
21	471.25	476.75
22	479.25	484.75
23	487.25	492.75
24	495.25	500.75
25	503.25	508.75
26	511.25	516.75
27	519.25	524.75
28	527.25	532.75
29	535.25	540.75
30	543.25	548.75
31	551.25	556.75
32	559.25	564.75
33	567.25	572.75
34	575.25	580.75
35	583.25	588.75
36	591.25	596.75
37	599.25	604.75

CH	Video	Audio
38	607.25	612.75
39	615.25	620.75
40	623.25	628.75
41	631.25	636.75
42	639.25	644.75
43	647.25	652.75
44	655.25	660.75
45	663.25	668.75
46	671.25	676.75
47	679.25	684.75
48	687.25	692.75
49	695.25	700.75
50	703.25	708.75
51	711.25	716.75
52	719.25	724.75
53	727.25	732.75
54	735.25	740.75
55	743.25	748.75
56	751.25	756.75
57	759.25	764.75
58	767.25	772.75
59	775.25	780.75
60	783.25	788.75
61	791.25	796.75
62	799.25	804.75
63	807.25	812.75
64	815.25	820.75

■ FOT channels

CH	Video	Audio
65	823.25	828.75
66	831.25	836.75
67	839.25	844.75
68	847.25	852.75
69	855.25	860.75

CH	Video	Audio
4	175.25	181.75
5	183.25	189.75
6	191.25	197.75
7	199.25	205.75
8	207.25	213.75
9	215.25	221.75

13 SPECIFICATIONS

◇ General

• Frequency coverage : (unit: MHz)

	Transmit	Receive
U.S.A	50–53.995,	0.495–824.000,
Canada	144–148, 430–450*1	849–869.000, 894–999.990
Asia	50–53.995, 144–148, 430–440	0.495–999.990
Australia	50–53.995, 144–148, 420–450*2	0.495–53.995, 108–135.995, 144–148, 420–450
Korea	50–53.995, 144–146, 430–440	0.495–29.995, 50–53.995, 88–107.995, 144–146, 430–440
Taiwan	50–50.2, 144–146, 430–432	50–50.2, 76–107.995, 144–146, 430–440
General	50–53.995, 144–148, 430–440	0.495–999.990

*1Guaranteed 440–450 MHz only

*2Guaranteed 430–440 MHz only

- Mode : FM, AM (Rx only),
WFM (Rx only)
- No. of memory channels : 555 (500 regular, 50 scan edges,
5 call)

- Usable temp. range : +14°F to +140°F;
–10°C to +60°C
- Tuning steps : 5, 6.25, 8.33, 9, 10, 12.5, 15, 20,
25, 30, 50, 100 and 200 kHz
- Frequency stability : ±6 ppm (+14°F to +140°F)
- Power supply : 5.5 to 11.5 V DC or specified
battery pack
- Current drain (at 8.0 V DC):
 - Tx High 50 MHz 2.0 A (typical)
 - 144, 430 MHz 2.0 A (typical)
 - Tx Low 50, 144 MHz 0.8 A (typical)
 - 430 MHz 1.2 A (typical)
 - Rx rated audio 220 mA (typical)
 - standby 100 mA (typical)
 - power save 65 mA (typical)
- Antenna connector : SMA (50)
- Dimensions : 2⁹/₃₂(W)×3⁷/₁₆(H)×1⁵/₃₂(D) in;
(projections not included) 58(W)×87(H)×29(D) mm
- Weight (approx.) : 9²⁹/₃₂ oz; 280 g
(with antenna and BP-217)

◇ Receiver

- Receive system : Double-conversion superheterodyne
- Intermediate frequencies : 1st 69.45 MHz (FM/AM)
13.35 MHz (WFM)
2nd 450 kHz
- Sensitivity (except spurious points; typical values):

FM	1.625–4.995 MHz	0.4 μ V
(at 12 dB SINAD)	5.000–49.995 MHz	0.18 μ V
	50.000–54.000 MHz	0.16 μ V
	54.005–143.995 MHz	0.18 μ V
	144.000–148.000 MHz	0.16 μ V
	148.005–221.995 MHz	0.4 μ V
	222.000–225.000 MHz	0.32 μ V
	225.005–246.995 MHz	0.4 μ V
	247.000–429.995 MHz	0.32 μ V
	430.000–450.000 MHz	0.16 μ V
	450.005–832.990 MHz	0.32 μ V
	833.000–999.990 MHz	1 μ V
WFM	40.000–108.0 MHz	1 μ V
(at 12 dB SINAD)	175–221.995 MHz	1.8 μ V
	470–770 MHz	3.2 μ V
AM	0.495–4.995 MHz	1.3 μ V
(at 10 dB S/N)	5.000–29.995 MHz	0.56 μ V
	118.000–136.000 MHz	0.5 μ V
	222.000–229.995 MHz	0.79 μ V
	320.000–329.995 MHz	1 μ V

- Selectivity (except WFM) : Less than 15 kHz/–9 dB
More than 30 kHz/–60 dB
- Spurious and image rejection ratio:

50, 144 MHz	Less than –60dB
430 (440) MHz	Less than –50dB

 (except half IF, 2nd image, 50 MHz band IF and WFM)
- Audio output power : 0.2 W typical at 10% distortion with an 8 Ω load
- Ext. speaker connector : 2-conductor 3.5(d) mm; $1/8$ "

◇ Transmitter

- Modulation system : Variable reactance frequency modulation
- Output power : High 5 W
(at 8.0 V DC) Low 0.5 W
- Spurious emissions : Less than –60 dB
- Max. frequency deviation: \pm 5.0 kHz
- Ext. MIC connector : 3-conductor 2.5(d) mm; $1/10$ " \sim 2 k

All stated specifications are subject to change without notice or obligation.

14 OPTIONS

AD-92SMA ANTENNA CONNECTOR ADAPTER

Allows you to connect an antenna with a BNC connector.
(SMA to BNC adapter)

BC-110AR/D/DR WALL CHARGER

Regularly charges BP-217 Li-ion battery pack in 15 hrs.

BC-139 DESKTOP CHARGER

Rapidly charges BP-217 Li-ion battery pack in 2 hrs. and 30 min.

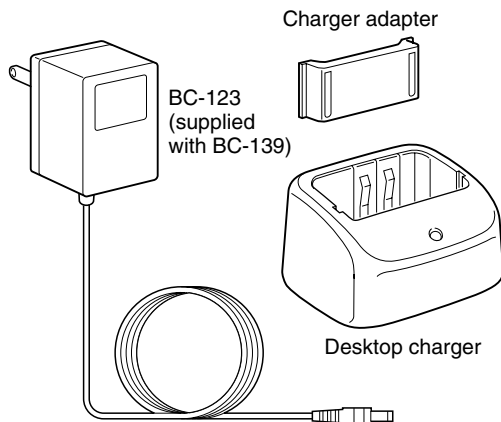

BP-216 BATTERY CASE

Battery case for R6 (AA) × 2 alkaline batteries.

BP-217 Li-Ion BATTERY PACK

7.4 V/1300 mAh Lithium Ion battery pack. Approx. 6 hrs. and 20 min. operating time in 50MHz band with high power, Tx : Rx : Standby = 1:1:8.

HM-54 SPEAKER-MICROPHONE

Slim dimensions. Equipped with an earphone jack and a transmit indicator.

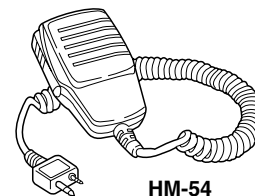

HM-75A REMOTE CONTROL MICROPHONE

Allows you to remotely select operating channels, etc.



HM-131 SPEAKER-MICROPHONE

For operation while conveniently hanging the transceiver from your belt, etc.

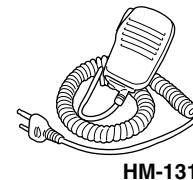

HM-128 EARPHONE-MICROPHONE

Ideal for hands-free operation by clipping the microphone with PTT switch to your lapel or breast pocket.

HS-94 EARHOOK HEADSET + **VS-1** VOX/PTT UNIT

Flexible boom microphone and rotating earpiece with a spring earhook.

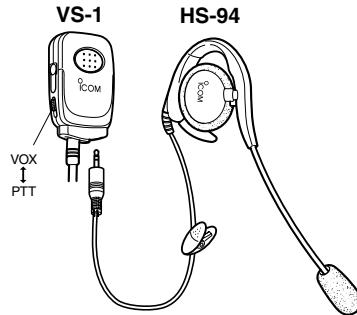

SP-13 EARPHONE

Provides clear receive audio in noisy environments.

LC-152A CARRYING CASE

Helps protect the transceiver from scratches, etc.

CP-19 CIGARETTE LIGHTER CABLE WITH NOISE FILTER

Used for operation and charging a battery pack connected to the transceiver via a DC power source. (11.5–16 V DC)

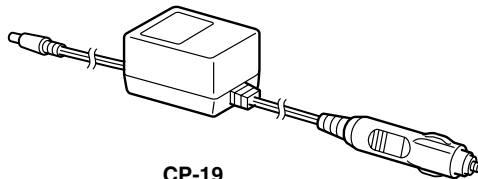

CP-19

CS-T90A CLONING SOFTWARE + OPC-478 CLONING CABLE

Allows you to transfer data from memories, etc. and quickly and easily edit and store data via a PC for Microsoft® Windows® 95/98 and ME. 1 RS-232C (COM) port is required.

OPC-474 CLONING CABLE

Used for handheld-to-handheld cloning.

Microsoft® and Windows® are registered trademarks of Microsoft Corporation in the U.S.A. and other countries.

Blank page

POCKET GUIDE

Important operating instructions are summed up in this and the following page for your simple reference.

By cutting along the line and folding on the dotted line, it will become a card sized operating guide which can easily be carried in a card case or wallet, etc.

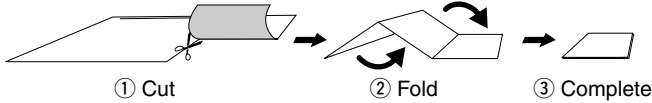

<CUT HERE>

- **Key lock function**
Push and hold [CALL/TV] for 1 sec. to turn the lock function ON and OFF.
- **SET mode operation**
 - ① Push and hold [8 SET] for 1 sec.
 - ② Rotate [DIAL] to select SET mode item.
 - ③ Push [8 SET] momentarily, then rotate [DIAL] to change the setting.
 - ④ Push [8 SET] momentarily to return to the condition of step ②.
 - ⑤ Push [VFO] to exit the SET mode.
- **CPU reset operation**
 - **ALL reset**
 - ① Turn power OFF.
 - ② While pushing and holding [BAND], [VFO] and [MR], turn power ON.
 - **Partial reset**
 - ① Turn power OFF.
 - ② While pushing and holding [VFO], turn power ON.

- **TV channel mode selection**
Push [CALL/TV] several times.
- **TV channel selection**
Rotate [DIAL].
- **TV channel skip setting**
 - ① Select TV channel mode.
 - ② Rotate [DIAL] to select desired channel.
 - ③ Push and hold [5 SKIP] for 1 sec.
- **Cancelling skip setting**
 - ① Select TV channel mode.
 - ② While pushing [BAND], rotate [DIAL] to select desired skip channel.
 - ③ Push and hold [SKIP] for 1 sec.
- **Exchange [DIAL] and [▲]/[▼] assignment**
Push and hold [1 V-D] for 1 sec.

POCKET GUIDE

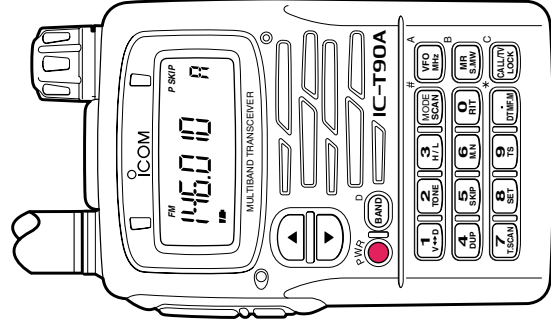

Icom Inc.

QUICK REFERENCE

■ **VFO/MEMORY MODE selection**
VFO mode : Push [VFO].
MEMORY mode : Push [MR].

■ **Changing frequency band**
Push [BAND].

■ **Frequency setting**

- ① Select VFO mode.
- ② Rotate [DIAL], or enter the desired frequency from the keypad.
[e.g. 1] 445,600 MHz
[4], [4], [5], [1], [6], [0], [0]
[e.g. 2] 0.684 MHz
[0], [.] , [6], [8], [4]

■ **Changing receiving mode**
Push [MODE].

■ **Adjusting audio output level**
Push [▲]/[▼] (continuously changes while holding).

■ **Adjusting squelch level**
While pushing [SQL] rotate [DIAL].

■ **MEMORY channel selection**
① Select MEMORY mode.
② Rotate [DIAL], or use keypad.

■ **MEMORY channel programming**
[e.g.] Program 445,600 MHz into MR CH 2

- ① Select VFO mode.
- ② Rotate [DIAL], or use keypad to set 445,600 MHz.
- ③ Push and hold [MR S.MW] for 1 sec. to indicate memory channels.
- ④ Rotate [DIAL] to select MR CH 2.
- ⑤ Push and hold [MR S.MW] for 1 sec. (VFO mode is selected after programming.)

■ **MEMORY channel clearing**

- ① Select the desired memory channel.
- ② Push and hold [MR S.MW] for 1 sec.
- ③ Push and hold [MR S.MW] for 1 sec. to clear the information.

■ **Scanning in VFO mode**

- ① Select VFO mode.
- ② While pushing and holding [MODE SCAN], rotate [DIAL] to select scan edge from (FULL), band (BAND) and program (PROG 0-24) scans.
- ③ Release [MODE SCAN] to start the scan.
- ④ Push [VFO] to stop the scan.

■ **Scanning in MEMORY mode**

- ① Select MEMORY mode.
- ② For the memory bank scan, push [MR] to select memory bank mode and push [BAND] to select the desired memory bank.
- ③ While pushing and holding [MODE SCAN], rotate [DIAL] to select scan mode from memory (ALL) and bank (BANK) scans.
- ④ Release [MODE SCAN] to start the scan.
- ⑤ Push [VFO] to stop the scan.

Count on us!

A-6134H-1EX
Printed in Japan
© 2002 Icom Inc.

Icom Inc.
1-1-32 Kamiminami, Hirano-ku, Osaka 547-0003 Japan