



RAILROAD PRODUCTS CATALOG

4TH EDITION

PRIMUS

RAILROAD DIVISION



Primus Electronics is proud to offer you the 2006 edition of our railroad catalog. For many years, Primus has been specializing in providing equipment and service to the railroad industry. Primus serves Class 1, Regional and Short Line Railroads through direct contact with end users, engineering and purchasing personnel.

Since 1998 Jack McNutt, Railroad Division Manager, has led Primus' Railroad efforts. Jack is extremely well versed in radio communications having served the industry for 39 years. He has held an Extra Class Amateur Radio License for almost 50 years with call sign K9OTB. Jack is also a certified Locomotive Engineer and Conductor. He currently works part-time for a south-central Indiana short line railroad. Jack brings a unique blend of radio system knowledge and a background in the workings of our customers that allows Primus to offer a level of service that is unmatched anywhere else in the railroad industry. Jack is an example of the commitment we make to our customers to provide the best quality and service available anywhere in the industry.

We hope that you find our 2006 Railroad Division Catalog to be as helpful as it is intended to be. In addition to these products, we supply many other types of equipment related to the railroad industry. Please let us know what your requirements are and we will find the appropriate equipment for your needs.

RAILROAD DIVISION CONTACTS			
Contact:	Jack McNutt	Gerry Fritzke	Corporate Office
Title:	Railroad Division Manager	NW Regional Sales Manager	18424 Northwest Frontage Road
Mobile:	(317) 796-0301	(360) 921-5945	Joliet, Illinois 60431
Office:	(888) 303-7245	(800) 279-8306	(800) 435-1636
Fax:	(317) 933-9197	(360) 892-3147	(800) 767-7605
Email:	jack@emr.net	gerryfritzke@comcast.net	sales@primuselectronics.com



PROUD MEMBERS OF:
ASLRRA is a non-profit trade association that represents the interests of its 425 short line and regional railroad members in legislative and regulatory matters. Phone: (202) 628-4500
NATE is a non-profit trade association dedicated to improving safety and promoting uniform standards throughout the tower construction and maintenance industry. Phone: (888) 882-5865
RSSI is a trade association serving the communication and signal segment of the rail transportation industry. Phone: (502) 327-7774

For additional copies of this catalog on CD-ROM or in print contact us at (800) 435-1636 or sales@primuselectronics.com

Toll-Free (800) 435-1636 • Fax (800) 767-7605

TABLE OF CONTENTS

Digital Video Recording Systems	4-5	Lantern Battery (Rechargeable)	21
Railroad Products	6-20	LOBO Trading ETD Parts	21
AEI Reader Replacement Parts	6	End of Train Antennas	22
Antenna Mount with Cable	6	Mobile Antennas	22
ATCS Parts	6	Communications Service Monitor	23
Axle Alternator Cable / Pulse Wabtec.....	6	Inflatable Lighting	23
Base Station Antenna Harness.....	6	Harger Railroad Products	24-48
Charger Extension and Replacement Cables.....	7	Signal Bonds (Welded)	24-30
Computer Wireless Accessories	7	Signal Hut Grounding.....	31
Conductance and Battery Testers	7	Ultraweld Connections	32-39
Defect Detector Interface Cables.....	7	Copper Lugs	40-41
Dummy Receptacles	7	Grounding and Bonding	42-43
ETD Battery Cable	8	Communications Site Equipment	44-48
ETD Battery Chargers.....	8	MSOA Vehicle Laptop Mounting Systems	49
ETD Battery Charger Replacement Cables.....	8	Memorylink Wireless Equipment	50
ETD Battery Pack Replacement Electronics Modules	8	BackTalk Locomotive Radio Tester	51
ETD Battery Pack Replacement Electronics.....	9	Battery Maintenance / Analyzer / Conditioner ..	52-53
ETD Battery Pack Replacement Parts.....	9	Adaptors	54
ETD Parts	9	Batteries	55
ETD Wiring Harness	10	Replacement Batteries	56-57
ETD RF Cables.....	10	Portable Replacement Antennas	58
ETD / HTD Bench Cables.....	11	Radio Manufacturer Cross Reference	59
Handset Adapter Cables	12	Motorola Aftermarket Products	60
HTD Adapter Cables.....	12	Converters / Power Systems / Battery Chargers	61
HTD Cables	12	Power Supplies	62-66
HTD Parts	12	Coaxial Protectors	67
HTD / ETD Parts	12	Locomotive Antennas	68
HTD Power Cables.....	13	Locomotive Antenna Footprint	69
HTD Power Cables / Pulse Wabtec.....	13	VHF Radio Antennas	69
HTD RF Cables	13	Base Station Antennas	70-71
HTD Specialized Adapter Cables	13	Land Mobile Antennas	72-73
HTD / ETD Bench Cables.....	14	Cable and Accessories	74-81
HTD / ETD Replacement Parts.....	15	Tool Bags and Accessories	82
HTD / ETD RF Cables	15	Communication Speakers	83
HTD / ETD Test Equipment	15	Mobile PA Amplifiers	84
Kenwood Radio Cables	15	Atlas Sound Horns and Speakers	84
LAN RF Cable	15	Microphone Covers	84
Locomotive Antennas	15	Railroad Handset Replacement Parts	85
Locomotive Cables.....	16	Chestpacks and Speaker / Microphone Holder ..	86
Locomotive Parts	16	Safety Vests and Breakaway Straps	87
Locomotive Radio Parts	16	Belts and Ballistic Nylon Pouches	88
Locomotive Radio Power Cables.....	16	2-Way Radio Cases—Leather	89-92
Locomotive Radio Replacement Parts.....	16	AAR Frequency Assignment Plan	93
Locomotive Radio RF Cables	17	Terms and Conditions	94
MCP Cables (Wabtec).....	17	Index by Description	95-99
Repair Adapter and Test Cables	17	Index by Product No.	
RF Bench Cables	17	Line Card	
Servo Head Control Cables.....	18		
Servo Hot Box Cables	18		
VLCC Specialized Cables	19		
NGEN ATX / Wabtec Specialized Items	20		
ETD Batteries—Sealed Lead Acid	21		
ETD Battery Charger—NiCAD	21		
Rear End Marker Batteries	21		

DIGITAL VIDEO RECORDING SYSTEMS

WatchDog Digital Video Recording System Optimized for Locomotives:

- Each Digital Video Recorder (DVR) can record the maximum number of cameras at up to 30 images per second per camera without degradation of quality
- Fully automated operation, the operator simply attaches the unit to a power outlet and attaches the camera (s). Recording is then automatic
- System status LED's provide a quick, easy and clear visual confirmation that the device is operational.
- Designed to offer a clear streaming video of train operation; recordings are fully indexed by date and time
- Hard drives are easily exchanged for data preservation. Included RAS software can lock and encrypt any portion of a recording making it tamper-proof. This preserves its value as evidence in an administrative or legal proceeding



SPECIFICATIONS:

- Electrical:* Std Vdc in: 12V, isolated. Other voltages available
- Mechanical:* Case is weatherized and lockable
Std Color: High Visibility Orange
Nom Dim: 8”H x 19.25”W x 16” D



- The DVR is initially configured to offer a continuous loop of recording. The locked, but easily exchanged hard drive can be removed quickly by authorized personnel for review
- The camera housing is powder-coated cast aluminum with a durable “Lexan” window
- Camera is designed to be mounted in the cab to provide an accurate representation of the engineer’s range of vision. An optional outdoor mount and camera with heater is available

COMPLETE WATCHDOG SYSTEMS

RR-5204/160/P1 Complete 2 camera DVR system, weatherized, 160 GB HDD

System includes RAS software, power/data interface box, 2 microphones, 2 camera mounts, heated camera enclosures and all necessary cabling for 2 camera system operation. Standard DVR can support up to 4 cameras and has video out jack. Additional camera (s) and camera cabling are sold separately.

WATCHDOG DVR

RR-5204/160 Weatherized, heated DVR unit for up to 4 cameras and 2 microphones.

System includes RAS software, power/data interface box. Standard DVR can support up to 4 cameras and has video out jack. Microphones, camera (s) and cabling are sold separately.

MICROPHONE OPTIONS

RR-5600 Weatherized microphone with integral mount

**Please contact Jack McNutt for a quote.
Phone: (888) 303-7245 or Email: jack@emr.net**

Toll-Free (800) 435-1636 • Fax (800) 767-7605

DIGITAL VIDEO RECORDING SYSTEMS

CAMERA OPTIONS

RR-5700	Weatherized camera enclosure and mount, w/o heater
RR-5700H	Weatherized camera enclosure and mount, w/heater
RR-5701	Replacement lens shield
RR-5702	HD weldable, 3/16" thick, CRS, mount plate



Camera in housing (mount not shown)

CABLE ASSEMBLIES

RR-5220/*	HD Camera-to-DVR cable assembly. Straight connectors both ends (specify length).
RR-5220C/*x*	HD Armored Camera-to-DVR cable assembly. Straight connector both ends (specify 'conduit length' x 'overall length').
RR-5222/*	HD Microphone-to-DVR cable assembly. Straight connector one end to RA connector (specify length).
RR-5222C/*x*	HD Armored Microphone-to-DVR cable assembly. Straight connector one end to RA connector (specify 'conduit length' x 'overall length').
RR-5312/*	Data interface box-to-DVR cable assembly (specify length).

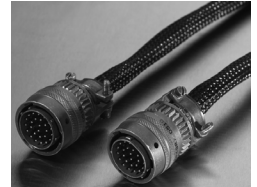

Data/Power Box Cable Assembly



Camera-to-DVR Cable Assembly

REPLACEMENT PARTS AND ACCESSORIES

RR-5225	Splice kit for one camera / microphone cable
RR-5227	Splice terminal box for up to 4 cameras and 2 microphones
RR-5310	Data / Power interface box, 10 ft leads, 12V/72V
RR-5000HDD/160	160GB HDD w/removable drive carrier
RR-5000HDD/250	250GB HDD w/removable drive carrier
RR-5000HDD/400	400GB HDD w/removable drive carrier
RR-5325	5.6" high resolution LCD monitor, NTSC, cables and case
RR-5450	GPS Module
RR-5500	Hard drive docking station w/software
RR-5705	Connector weather-seal kit



Digital Video Recorder Case



Data/Power Box

DC TO DC CONVERTER: 72VDC TO 12VDC

72-12-6ISP	Optional. Offers the benefits of an isolated converter plus protection against line transients and voltage spikes. A special circuit clamps input spikes to a safe level protecting both the converter and the powered equipment. Input Voltage: 42-90, Output Voltage: 13.6; Output Amps: Intermittent—6, Continuous—6.	\$404.25
------------	--------------------------------------------------------------------------------------------------------------------------------------------------------------------------------------------------------------------------------------------------------------------------------------------------------------------------	----------

RAILROAD PRODUCTS

AEI READER REPLACEMENT PARTS

Product #	Description	Price
RR-176	AEL Reader Connector Kit #1, w/10' power cable	\$35.04
RR-176NPC	AEI Reader Connector Kit #1, no power cable	\$28.06
RR-176PC	10' power cable for AEI Reader Connector Kit #1	\$8.56
RR-177	AEI Reader Connector Kit #2	\$26.20

ANTENNA MOUNT WITH CABLE

Product #	Description	Price
RR-067	03LP-04 Equiv., RG58A, Brass 3/4 mount to BNC/m; Length: 30'	\$28.47
RR-167	Weatherproof NMO mount, RG58, Length: 17'	\$23.26

ATCS PARTS

Product #	Description	Price
RR-179/030	ATCS, Monitor 9000 Series MCP setup cable, metal shells; Length: 30'	\$52.01

AXLE ALTERNATOR CABLE/PULSE WABTEC



RR-095CA

Product #	Description	Price
RR-095CA/078	Axle Alternator Cable, 60 PPR, Bayonet Type Connector; Length: 78"	\$91.69
RR-095CA/102	Axle Alternator Cable, 60 PPR, Bayonet Type Connector; Length: 102"	\$99.37
RR-095CA-20PPR/102	Axle Alternator Cable, 20 PPR, Bayonet Type Connector; Length: 102"	\$99.37
RR-095MS/078	Axle Alternator Cable, 60 PPR, Thread Type Connector; Length: 78"	\$38.20
RR-098R/078	Axle Alternator Cable, Wabtec/Pulse, (Odometer Cable), Right Angle Connector; Length: 78"	\$38.28
RR-098S/078	Axle Alternator Cable, Wabtec/Pulse, (Odometer Cable), Straight Connector; Length: 78"	\$32.54

BASE STATION ANTENNA HARNESS

Product #	Description	Price
RR-160/160MHZ	2 Bay Stacking Harness, Tuned 160 MHz, N/m connectors (Ant), N/f center feed	\$48.68
RR-160/450MHZ	2 Bay Stacking Harness, Tuned 450 MHz, N/m connectors (Ant), N/f center feed	\$43.17

Toll-Free (800) 435-1636 • Fax (800) 767-7605

RAILROAD PRODUCTS

CHARGER EXTENSION AND REPLACEMENT CABLES

Product #	Description	Price
P-11202-10FT	Extension cable for Pulse charger& Battery Extender Cable. Length 10'. (11202)	\$105.98
P-11202-3FT	Extension cable for Pulse charger & Battery Extender Cable. Length 3'. (11202)	\$91.34
P-11202R-10FT	Replacement cable for Pulse charger. Length 10' (11122)	\$59.87
P-11202R-3FT	Replacement cable for Pulse charger. Length 3' (11122)	\$46.27
RR-097	ETD - NiCad Battery Extension Cable; (4) Banana/jack + (4) Banana/plug; Length - 4 ft	\$40.71



P-11202



P-11202R

COMPUTER WIRELESS ACCESSORIES

RR-184/012	Sierra Wireless adapter cable, SSMB Nano right angle + FME/m; Length: 12"	\$20.72
------------	---------------------------------------------------------------------------	---------

CONDUCTANCE AND BATTERY TESTERS

RRP-216	EOT Conductance and battery tester. For direct readout of voltage and conductance in batteries A & B. For use with both Hi Cap and Lo Cap Smartpacks. LCD readout plus green LED "GO" and two red LED's "NO GO"	CALL
RRP-217	EOT Conductance and battery tester. A smaller version of RRP-216 with no LCD readout	CALL
RRP-218	EOT Conductance and battery tester. For EOT NiCAD batteries. Direct readout of battery voltage and conductance. LCD readout plus green LED "GO" and two red LED's "NO GO"	CALL
RRP-219	EOT Conductance and battery tester. A smaller version of RRP-218 with no LCD readout	CALL

DEFECT DETECTOR INTERFACE CABLES

RR-091/010	TK-762G Kenwood Wayside Radio Interface to STC cable; Length: 10'	\$27.18
RR-091	TK-762G Kenwood Wayside Radio Interface to STC cable; Length: 3'	\$20.71
RR-102	TK-762G Kenwood Wayside Radio Interface to open; Length: 5'	\$17.12
RR-093/010	MaxTrac 300, NG HBD Radio Interface to STC cable; Length: 5'	\$36.02



RR-091/010



RR-093/010

DUMMY RECEPTACLES

+CIRDUM/1	Dummy Receptacle for the E.O.T. or radio power connector. Four hole flush mount. Used for storing connectors when not in use.	\$11.25
P-019	Dummy Receptacle for the Locomotive Radio Cable or the E.O.T. Cable flush mount. Four hole flange, UHF/female. Used for storing antenna connector when not in use.	\$8.55
RR-043	Dummy Receptacle, 4 Hole Flange to hold HTD / Clean Cab Radio Control cords during maintenance.	\$13.44
RR-044	Flush Mount 4-Hole Flange UHF/f, Dummy Receptacle to hold antenna connection during maintenance.	\$2.05

For product updates visit www.railroadpc.com

RAILROAD PRODUCTS**ETD BATTERY CABLES**

Product #	Description	Price
RR-075	EOT Smartpack Jumper Cable, +12V Red, -12V Black; Length: 3'. Standard connector + un-terminated ends	\$37.62
RR-076	EOT Battery pack to HTD adapter cable; Length: 3'	\$70.71

ETD BATTERY CHARGERS

Product #	Description	Price
RRP-330	Single Output, 24 V Bench Charger w/test port for Next-Gen EOT	\$432.64
RRP-331	Single Output, 24 V Charger for Next-Gen EOT	\$406.36
RRP-332	Dual Output, 24 V Charger for Next-Gen EOT	\$534.86
RRP-334	Quad Output, 24 V Charger for Next-Gen EOT	\$1,027.56
RRP-336	Single Port Charger w/ conductance tester for RediPack/SmartPack Batteries	\$470.00
RRP-338	Dual Port Combined Charger w/ conductance tester for RediPack/SmartPack and Next Gen EOT	\$856.66

ETD BATTERY CHARGER REPLACEMENT CABLES

Product #	Description	Price
RRP-330.1/36	Replacement Next-Gen Charge cable for RRP-330, RRP-331, RRP-334, RRP-338 Series Charger; Length: 3'	\$78.94
RRP-330.1/72	Replacement Next-Gen Charge cable for RRP-330, RRP-331, RRP-334, RRP-338 Series Charger; Length: 6'	\$84.23
RRP-330.2/72	Replacement Serial cable for RRP-330 series charger; Length: 6'	\$10.20
RRP-330.3/36	Replacement AC power cord for RRP-330 thru RRP-388 series chargers; Length: 3'	\$6.50
RRP-336.1/120	Replacement RediPack charge cable for RRP-336 thru RRP-338 series chargers; Length: 10'	\$101.18

ETD BATTERY PACK REPLACEMENT ELECTRONICS MODULES

Product #	Description	Price
RRP-201	Redipack, Hi-Cap 5Ah battery pack for Wabtec EOT devices, Grey	CALL
RRP-201BN	Redipack, Hi-Cap 5Ah battery pack for Wabtec EOT devices, Orange, Stamped BNSF	CALL
RRP-201NS	Redipack, Hi-Cap 5Ah battery pack for Wabtec EOT devices, Grey, NS Stamp	CALL
RRP-202	Redipack, Lo-Cap 3.4Ah battery pack for Wabtec EOT devices, Grey	CALL

RAILROAD PRODUCTS

ETD BATTERY PACK REPLACEMENT ELECTRONICS

Product #	Description	Price
RRP-203	Replacement Electronics Module for Smartpack / RediPack Hi-Cap Battery Pack	\$113.33
RRP-204	Replacement Electronics Module for Smartpack / RediPack Lo-Cap Battery Pack	\$155.00

ETD BATTERY PACK REPLACEMENT PARTS

Product #	Description	Price
RR-052	ETD Harness Plate Replacement Connector, mates with Smart Pack III Battery Pack	\$54.26
RR-072	Replacement connector assembly for Hi-Cap Smartpack, 18 gauge wire, Potted. Includes 3" heat shrink w/ hot melt glue	\$31.44
RR-073	Replacement connector assembly for Lo-Cap Smartpack, 18 gauge wire, Potted. Includes 3" heat shrink w/ hot melt glue	\$26.61
RRP-205	TrainLink II Hi Cap Replacement Lid, Grey, Includes Reflective Tape	\$57.03
RRP-205BN	TrainLink II Hi Cap Replacement Lid, Orange, Stamped BNSF, Includes Reflective Tape	\$57.03
RRP-205UP	TrainLink II Hi Cap Replacement Lid, Yellow, Stamped UP, Includes Reflective Tape	\$57.03
RRP-205WC	TrainLink II Hi Cap Replacement Lid, Grey, Stamped WC, Includes Reflective Tape	\$57.03
RRP-206	TrainLink II Lo Cap Replacement Lid, Grey, Includes Reflective Tape	\$44.40
RRP-206BN	TrainLink II Lo Cap Replacement Lid, Orange, Stamped BNSF, Includes Reflective Tape	\$44.17
RRP-207	TrainLink II Hi Cap Replacement Battery Housing, Grey, Includes Reflective Tape	\$77.23
RRP-208	TrainLink II Lo Cap Replacement Battery Housing, Grey, Includes Reflective Tape	\$77.23
RRP-209	Battery Lid Gasket	\$11.92
RRP-210	Hi Cap Packing Material, 4 pcs, for Wabtec Trainlink II / RediPak Battery Housings	\$20.26
RRP-211	Lo Cap Packing Material, 4 pcs, for Wabtec Trainlink II / RediPak Battery Housings	\$20.26
RRP-225	Reflective Tape for HI-CAP EOT Battery	\$6.96
RRP-226	Reflective Tape for LOW-CAP EOT Battery	\$6.96
97-50-150-15	ETD Battery Latch. (3516 South Co.) No minimum order. In Stock.	\$6.00

ETD PARTS

Product #	Description	Price
RR-047	ETD - ES, Trainlink II, ATX, Replacement Connector w/Shroud P/N 3162. 5 per Pack	\$20.05
RR-047.1	ETD - ES, Trainlink II, ATX, P/N 3162 replacement pins. 170 / pack	\$12.92

For product updates visit www.railroadpc.com

RAILROAD PRODUCTS



RR-005



RR-006

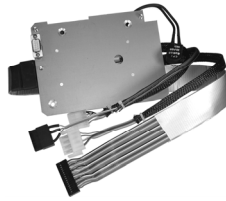

RR-007

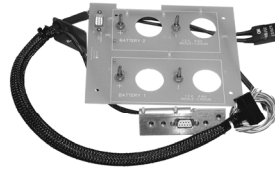

RR-033

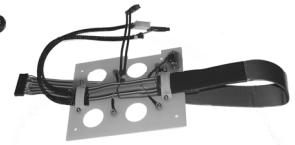

RR-040

ETD WIRING HARNESS

Product #	Description	Price
RR-005	ES EOT wiring harness. Complete. (11169)	\$186.31
RR-033	EOT Harness and board assy. Convert EOT-07 from Smartpack to NiCad batteries. Replacement for EOT-08 + EOT-09. (11132)	\$238.08
RR-033.1	EOT Harness and board assy. Convert EOT-07 from Smartpack to NiCad batteries. CNIC Harness	\$235.49
RR-040	EOT Harness for EN-EOT Complete. (Original # 11159. New # 10870)	\$227.95
RR-006	Trainlink II wiring harness. Complete. (11162)	\$233.03
RR-006.1	Trainlink II Battery Plate w/Battery Connector and 8 inch leads	\$62.77
RR-007	ATX wiring harness. Complete. (22171)	\$167.06
RRP-240	LED Display Board for Trainlink II	\$96.37
RRP-089	ETD Display Replacement Ribbon Cable, Length - 2 inches	\$9.05



P-6MMSQ



P-13MQSQ

ETD RF CABLES

Product #	Description	Price
P-6MMSQ	TRAINLINK II RF cable; Length: 6.25". RG-58A/U Belden, Mini-UHF/Male; SMA/Male/right angle, strain relief on both ends. (4722)	\$19.50
P-13MQSQ	ES/ATX RF cable; Length: 13". RG-58A/U Belden, Mini-UHF/Male/right angle; SMA/Male/right angle, strain relief on both ends. (11160)	\$22.89
RR-010	EOT -07, ES ATX RF cable; Length: 8.75". RG316T, Mini-UHF Male +SMA/Male, right angle; 3/4" strain relief on each end. (22978)	\$20.27
RR-113	Replacement lead for Wabtec Antenna, RG316, Mini-UHF/m; Length: 9"	\$27.35
RR-186	ES/ATX RF cable: Length: 7.5"	\$22.70

RAILROAD PRODUCTS



RR-008

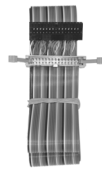

RR-009



RR-041



RR-045

ETD / HTD BENCH CABLES

RR-008	Trainlink II extender cable; Length: 52". (20894)	\$67.23
RR-009	ES/ATX extender ribbon cable; Length: 52". (20895)	\$61.80
RR-035	ETD Bench test cable. TS8XBNC18.3K, 18" BNC Male to Mini-UHF Male cable assembly, RG8/X. Swept from 100 MHz-3000 MHz.	\$20.27
RR-036	ETD Bench test cable. TS8XBNC30.3K, 30" BNC Male to Mini-UHF Male cable assembly, RG8/X. Swept from 100 MHz-3000 MHz.	\$19.76
RR-041	ETD Ext Cable, 50 Cond. 28 AWG Ribbon, Length 36". Microprocessor to Aux. Board. Used on ES, ATX, CSX-EN.	\$64.78
RR-045	ETD Download/Pressure Calibrator. Incl. Box and all Cables. (17184).	\$97.42
RR-051	HTD Software Download Cable, 6 Pos. Circular Plug, D Sub 9/f; Length: 6'.	\$33.16
RR-077	US&S DIGITAIR 6696 HTD, Internal Test Extension Cable; Length: 12"	\$29.39
RR-080	Octopus' Extender cable for repair of NGEN ATX. Allows removal of electronics cage; Length: 4'	\$65.76
RR-088A-1.825	TLK-HOYXCVR-8TXCN Equiv, Coax Jumper, Style A; Length: 1.825"	\$12.37
RR-088A-3.125	TLK-HOYXCVR-8TXCN Equiv, Coax Jumper, Style A; Length: 3.125"	\$12.42
RR-088B-3.10	TLK-HOYXCVR-8TXCN Equiv, Coax Jumper, Style B; Length: 3.100"	\$12.42
RR-088B-4.10	TLK-HOYXCVR-8TXCN Equiv, Coax Jumper, Style B; Length: 4.100"	\$12.47
RR-108	Serial Connector Cable for Wabtec 15622 & 15623 Radios, w/RSSI Test Point (BNC/f); Length: 4'	\$28.29
RR-110	RF to Processor Board Extender Cable for Wabtec 15622 & 15623 Radios; Length: 12"	\$85.09
RR-115	Power Supply to ETD, Bench Cable; Length: 4'	\$61.57
RR-119	Pony Programmer for Synthesized Digital Radio Cable; Length: 4'	\$71.08
RR-127	CA3108E14S-6PB; 6 Position Receptacle, Right Angle, Pin, Bayonet Style, Cannon	\$100.15
RR-128	CA3106E14S-5SB; 5 Position Receptacle, Straight, Socket, Bayonet Style, Cannon	\$82.00
RR-129	CA3106E14S-6SB; 6 Position Receptacle, Straight, Socket, Bayonet Style, Cannon	\$87.96
RR-130	TrainLink ES07 Programming Cable; Length: 6'	\$126.71
RR-149	Wabtec Interface Cable; Length: 48"	\$31.78
RRD-001	Quantum 3481 ETD Radio Module to Processor Module Breakout Cable w/Rx test port; Length: 18"	\$117.56
RRD-002	Quantum Cellular 3484 ETD Radio Module to Processor Module Breakout Cable w/Rx test port; Length: 18"	\$124.52
RRD-1001	Processor Board to RRP-D1000 Radio Replacement Cable w/test port for Wabtec Trainlink II HTD	\$32.60

For product updates visit www.railroadpc.com

RAILROAD PRODUCTS**HANDSET ADAPTER CABLES**

Product #	Description	Price
RR-074	Locomotive Handset Extension Cable, 18 AWG, 6 position plug to spade lug; Length: 36"	\$31.41

HTD ADAPTER CABLES

Product #	Description	Price
RR-071	HTD US&S 4 pin to 5 pin Power Adapter Cable; Length: 10"	\$76.52
RR-145	HTD US&S 5 pin to 4 pin Power Adapter Cable; Length: 10"	\$136.15

HTD CABLES

Product #	Description	Price
PRIMUS2IL-008	HTD Internal Interface Cable; Length: 3"	\$217.15
PRIMUS2IL-044	Integrated HTD RF Cable Assy, RG58, N Female Bulkhead, UHF Male; Length 10.5".	\$27.96

HTD PARTS

Product #	Description	Price
RR-004	ETD - ES, Trainlink II, ATX, Replacement Shroud portion only of P/N 3162 (68756-024)	\$7.33
RR-004.1	ETD - ES, Trainlink II, ATX, Replacement Housing, 2x13, .100x.100 (65043-024)	\$0.24
RR-004.2	ETD - ES, Trainlink II, ATX, Replacement .100 Centerline Crimp-to-wire receptacle	\$0.23
RR-013	Pulse HTD 6 position replacement connector, Pin Extensions Attached.	\$25.03
RR-048	Replacement Emergency Switch. HTD. (3467)	\$42.18
RR-049	Replacement Switch Guard. HTD. (3463)	\$20.28
RR-069	Replacement Switch Guard. HTD. Eaton 9628, 8497K2, MS25224-2, EATON	\$44.81

HTD / ETD PARTS

Product #	Description	Price
RR-135	DMS3106A-18-1P; Strt Angle, Plug, DDK	\$19.11
RR-161/100	Lacing Cord, .085 width, White, 100 ft	\$14.32
RR-164	ES, Trainlink II, ATX, Replacement Shroud & Header (2713162)	\$7.09
RR-173	Rubberized Test / Arm Switch for ES, Trainlink II, and ATX EOT	\$30.19

**We have many new products in development.
Please contact us with your special requests!**

Toll-Free (800) 435-1636 • Fax (800) 767-7605

RAILROAD PRODUCTS

HTD POWER CABLES

Product #	Description	Price
P-006	HTD Power Cable for US & S; 78". 4C, 4 pin Amphenol Strt conn w/ srlf. Pin A +72V, Pin C-72V, Pin B+12V, PinD-12V	\$44.71
P-007	HTD Power Cable for Pulse; length 15 Ft, 10 conductor, 18 gauge, Amphenol Strt Conn w/ strain relief.	\$82.77
P-007RA	HTD Power Cable for Pulse; length 15 Ft, 10 conductor, 18 gauge, Amphenol RA Conn w/ strain relief.	\$87.32
P-007RA/240	HTD Power Cable for Pulse; length 20 Ft, 10 conductor, 18 gauge, Amphenol RA Conn w/ strain relief.	\$97.67
P-007RA/78	HTD Power Cable for Pulse; length 78", 10 conductor, 18 gauge, Amphenol RA Conn w/ strain relief.	\$74.91
RR-034	HTD. Power Cable for US & S; 78". 4C, 4 pin Amphenol RA conn w/ srlf. Pin A +72V, Pin C-72V, Pin B+12V, PinD-12V.	\$78.28
RR-037	12V Power Cable for Pulse & Quantum HDT. Amphenol conn w/ sr, 60" of 18 awg cable, Red +12V, Black -12V, fused plug.	\$55.42
RR-168	HTD Power Cable, PTO8E-14-5S, Right Angle Connector; Length: 78"	\$129.75

HTD POWER CABLES/PULSE WABTEC

Product #	Description	Price
RR-094/078	5 pin, HTD Power Cable; Length: 78"	\$76.30
RR-094/102	5 pin, HTD Power Cable; Length: 102"	\$77.58



RR-094

HTD RF CABLES

Product #	Description	Price
RR-003	Integrated HTD RF Cable Assy, N Female Bulkhead, UHF Male; Length 15". Equiv to Pulse P/N 11236	\$20.95
RR-031	Integrated HTD RF Cable Assy, RG58, N Female Bulkhead, UHF Male; Length: 10.5".	\$20.71
RR-105/14	83284 Belden; RG316, SMB/plug-ra+N/m; Length: 14"	\$24.31
RR-105/36	83284 Belden; RG316, SMB/plug-ra+N/m; Length: 36"	\$27.65
RR-105/48	83284 Belden; RG316, SMB/plug-ra+N/m; Length: 48"	\$27.04
RFU-603	Mini-UHF bulkhead connector; Female 4-hole panel mount die-cast. (6081)	\$2.23



RR-003



RR-105

HTD SPECIALIZED ADAPTER CABLES

Product #	Description	Price
RR-117	Adaptor Cable to Allow use of a CN RDU on "ES" Equipped Locomotives. See RR-154 for the opposite.	\$420.00
RR-154	Adaptor Cable to Allow use of a ES RDU on "CN" Equipped Locomotives. See RR-117 for the opposite.	\$369.09

For product updates visit www.railroadpc.com

RAILROAD PRODUCTS



RR-108



RR-115



RR-119

HTD / ETD BENCH CABLES

RR-008	Trainlink II extender cable; Length: 52". (20894)	\$67.23
RR-009	ES/ATX extender ribbon cable; Length: 52". (20895)	\$61.80
RR-035	ETD Bench test cable. TS8XBNC18.3K, 18" BNC Male to Mini-UHF Male cable assembly, RG8/X. Swept from 100 MHz-3000 MHz.	\$20.27
RR-036	ETD Bench test cable. TS8XBNC30.3K, 30" BNC Male to Mini-UHF Male cable assembly, RG8/X. Swept from 100 MHz-3000 MHz.	\$19.76
RR-041	ETD Ext Cable, 50 Cond. 28 AWG Ribbon, Length 36". Microprocessor to Aux. Board. Used on ES, ATX, CSX-EN.	\$64.78
RR-045	ETD Download/Pressure Calibrator. Incl. Box and all Cables. (17184).	\$97.42
RR-051	HTD Software Download Cable, 6 Pos. Circular Plug, D Sub 9/f; Length: 6'.	\$33.16
RR-077	US&S DIGITAIR 6696 HTD, Internal Test Extension Cable; Length: 12"	\$29.39
RR-080	Octopus' Extender cable for repair of NGEN ATX. Allows removal of electronics cage; Length: 4'	\$65.76
RR-088A-1.825	TLK-HOYXCVR-8TXCN Equiv, Coax Jumper, Style A; Length: 1.825"	\$12.37
RR-088A-3.125	TLK-HOYXCVR-8TXCN Equiv, Coax Jumper, Style A; Length: 3.125"	\$12.42
RR-088B-3.10	TLK-HOYXCVR-8TXCN Equiv, Coax Jumper, Style B; Length: 3.100"	\$12.42
RR-088B-4.10	TLK-HOYXCVR-8TXCN Equiv, Coax Jumper, Style B; Length: 4.100"	\$12.47
RR-108	Serial Connector Cable for Wabtec 15622 & 15623 Radios, w/RSSI Test Point (BNC/f); Length: 4'	\$28.29
RR-110	RF to Processor Board Extender Cable for Wabtec 15622 & 15623 Radios; Length: 12"	\$85.09
RR-115	Power Supply to ETD, Bench Cable; Length: 4'	\$61.57
RR-119	Pony Programmer for Synthesized Digital Radio Cable; Length: 4'	\$71.08
RR-127	CA3108E14S-6PB; 6 Position Receptacle, Right Angle, Pin, Bayonet Style, Cannon	\$100.15
RR-128	CA3106E14S-5SB; 5 Position Receptacle, Straight, Socket, Bayonet Style, Cannon	\$82.00
RR-129	CA3106E14S-6SB; 6 Position Receptacle, Straight, Socket, Bayonet Style, Cannon	\$87.96
RR-130	TrainLink ES07 Programming Cable; Length: 6'	\$126.71
RR-149	Wabtec Interface Cable; Length: 48"	\$31.78
RRD-001	Quantum 3481 ETD Radio Module to Processor Module Breakout Cable w/Rx test port; Length: 18"	\$117.56
RRD-002	Quantum Cellular 3484 ETD Radio Module to Processor Module Breakout Cable w/Rx test port; Length: 18"	\$124.52
RRD-1001	Processor Board to RRP-D1000 Radio Replacement Cable w/test port for Wabtec Trainlink II HTD	\$32.60

RAILROAD PRODUCTS

HTD / ETD REPLACEMENT PARTS

Product #	Description	Price
RR-089	ETD Display Replacement Ribbon Cable; Length: 2"	\$9.05
RRP-240	LED Display Board for Trainlink II	\$96.37

HTD / ETD RF CABLE

Product #	Description	Price
RR-147	Adapter Cable for WABTEC23660. Fits RR-107, RR-137	\$24.60

HTD / ETD TEST EQUIPMENT

Product #	Description	Price
RR-107	Break Out Box for Wabtec NGEN Radio Transceiver	\$172.37
RR-112	ETD Charger Simple Test Set	\$88.96
RR-137	Universal ETD Transceiver Test Box; connects to Data radio JSLM, Wabtec 15572, 15623, (23660 XCVR with Primus Adapter)	\$83.73
RR-138	JSLM, Ritron, EOT Transceiver programming cable; RNET15 pin compatible transceivers, requires mfr. software	\$82.99



RR-112

KENWOOD RADIO CABLES

Product #	Description	Price
RR-079	TKR 740 Kenwood Dispatch Console Cable, D15M+D25M; Length - 36 inch	\$21.16
RR-092	TK 790 Kenwood Dispatch Console Cable, D15M + D25M; Length: 36"	\$33.79
RR-092/72	TK 790 Kenwood Dispatch Console Cable, D15M + D25M; Length: 72"	\$39.75
RR-121	GTC 400 to Kenwood TK790 Cable; Length - 3 Feet	\$24.11

LAN RF CABLE

Product #	Description	Price
RR-148	LMR195, N/f + RPTNC/plug; Length - 36 inches	\$16.75

LOCOMOTIVE ANTENNAS

Product #	Description	Price
RR-085	1/4 wave antenna, 166 MHz, PL259 base, .042 stainless whip	\$17.82
RR-086	Locomotive 1/4 wave Antenna, Custom Base, 161 MHz	\$55.75

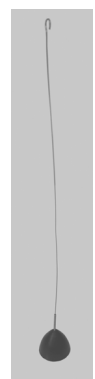

RR-086

For product updates visit www.railroadpc.com

RAILROAD PRODUCTS**LOCOMOTIVE CABLES**

Product #	Description	Price
RR-062	Cable, 12 Pin Aux, Clean Cab Radio, PH-12+67-02E14-12S; Length: 26"	\$202.44
RR-109	Heavy Duty, 6 pin plug to Rt Angle 6 pin Plug; Microphone Coiled Cable, 2.5/10 Ft. Telex Headset Cable	\$99.52
RR-126	Locomotive Event Recorder Download Cable	\$157.73

LOCOMOTIVE PARTS

Product #	Description	Price
RR-043	Dummy Receptacle, 4 Hole Flange to hold HTD / Clean Cab Radio Control cords during maintenance.	\$13.44
RR-044	Flush Mount 4-Hole Flange UHF/f, Dummy Receptacle to Hold Antenna connection during maintenance.	\$2.05
RR-131	Replacement AAR Standard Plug assembly for Locomotive Radio Handset	\$14.28
RR-131SR	Strain Relief for AAR Standard Plug assembly for Locomotive Radio Handset	\$5.46
RR-132	Replacement AAR Standard 4-Hole Box Mount Receptacle for Locomotive Radio Handset	\$19.80

LOCOMOTIVE RADIO PARTS

Product #	Description	Price
P-015RA	Replacement Connector for Clean Cab Radio Power Cord, R/A.	\$61.26
RR-169	Locomotive Radio Second Handset Control Kit; Length: 25'	\$348.86

LOCOMOTIVE RADIO POWER CABLES

P-005	Clean Cab Radio Power Cable, 72V Only, Straight Circular Connector + Open; Length: 78". USE RR-165	\$40.72
P-005RA	Clean Cab Radio Power Cable, 72V Only, Right Angle Circular Conn. to Open; Length: 78". USE RR-070	\$45.89
RR-070	Clean Cab Radio Power Cable, 72V Only, Right Angle Circular Conn. to Open; Length: 78"	\$45.89
RR-165	Clean Cab Radio Power Cable, 72V Only, Straight Circular Connector + Open; Length: 78" Same as P-005	\$41.04
RR-174	Loco Radio Power Cable; 78". Right Angle Conn. Pin A +72V, Pin C-72V, Pin B+12V, Pin - D-12V	\$52.43
RR-175	Loco Radio Power Cable; 78". Straight Conn. Pin A +72V, Pin C-72V, Pin B+12V, Pin - D-12V	\$44.71

LOCOMOTIVE RADIO REPLACEMENT PARTS

RR-039	HKN9088 Equiv. RG142, Mini-UHF/m + UHF/m; Length: 96"	\$50.92
RR-064	67-06C14-12P ; Clean Cab Radio Replacement Connector, 12 Pin.	\$243.30
RR-153	67-02E14-12S, 4-Hole Flange, Replacement Connector for Clean Cab Radio.	\$185.17

Toll-Free (800) 435-1636 • Fax (800) 767-7605

RAILROAD PRODUCTS

LOCOMOTIVE RADIO RF CABLES

Product #	Description	Price
RR-103	Clean Cab Radio Internal RF Cable, RG316, UHF/f 2 hole Flange w/hood + Open w/ solder terminal; Length: 15"	\$22.44
RR-104	Clean Cab Radio Internal RF Cable, RG58A/U; UHF/m+UHF/f-2 hole flange w/ hood; Length: 7"	\$23.76



RR-103

MCP CABLES (WABTEC)

Product #	Description	Price
RR-155	Power Supply to Processor Cable for WABTEC MCP, RDR-900; Length: 3.25"	\$16.42
RR-156	Processor to Interconnect for WABTEC MCP, RDR-900, 2x30 Recept. to 2x30 Header; Length: 2"	\$22.81
RR-157	Microprocessor to RF Board Cable for WABTEC MCP, RDR-900	\$24.00
RR-158	RF Cable for WABTEC MCP RDR-900; RG316, N/f-bh to Open; Length: 2.5"	\$13.90

REPAIR ADAPTER AND TEST CABLES

RR-082	4-Hole Flange Mount, N/f+N/f, Pass Thru Panel Adapter.	\$15.25
RR-120	316 DS Thermax; N/f+N/m, Flexible RF Test Cables; Length: 60"	\$26.57

RF BENCH CABLES

RR-081	LMR195; N/m-ra + SMA/m-ra; Length: 14"	\$26.62
RR-087/0240	213, N/m + N/m; Length: 20"	\$44.63
RR-087/0300	213, N/m + N/m; Length: 25"	\$51.48
RR-122	RG8U; N/f + N/m; Length: 15"	\$33.36
RR-123/018RA	174 Belden; SMB/plug- ra + BNC/m; Length: 18"	\$19.40
RR-123/036	174 Belden; SMB/plug + BNC/m; Length: 36"	\$18.16
RR-123/36RA	174 Belden; SMB/plug-ra + BNC/m; Length: 36"	\$20.27
RR-124/36	58A/U; N/m + SMA/f; Length: 36"	\$16.39
RR-124/48	58A/U; N/m + SMA/f; Length: 48"	\$16.83
RR-125/36	58A/U; N/m + SMA/m; Length: 36"	\$16.37
RR-133/012	RG8, N/f-bh + UHF/m; Length: 12"	\$20.51
RR-133/013	RG8, N/f-bh + UHF/m; Length: 13"	\$20.61
RR-136/036	RG8, N/m + N/m; Length: 36"	\$19.35
RR-141/036	RG8U, N/m + UHF/m; Length: 36"	\$18.50



RR-124

For product updates visit www.railroadpc.com

RAILROAD PRODUCTS

SERVO HEAD CONTROL CABLES

Product #	Description	Price
RR-050	SERVO Cyberscan/ACS Defect Detector, Head Control Cable	\$22.04



RR-012



RR-055



RR-083

SERVO HOT BOX CABLES

Product #	Description	Price
RR-012	Servo 8909 Equip Hot Box Cable; Length: 14.25 Armor, 17 ft - 9 in Cable	\$480.39
RR-055/015X116	4000-7946 Equip., Servo ACS type Defect Detector (Hot Box) Cable; Overall Length: 116 ft; first 15 ft Armored.	\$1,255.68
RR-055/017X065	4000-7946 Equip., Servo ACS type Defect Detector (Hot Box) Cable; Overall Length: 65 ft; first 17 ft Armored.	\$985.88
RR-055/017X085	4000-7946 Equip., Servo ACS type Defect Detector (Hot Box) Cable; Overall Length: 85 ft; first 17 ft Armored.	\$1,037.75
RR-055/017X100	4000-7946 Equip., Servo ACS type Defect Detector (Hot Box) Cable; Overall Length: 100 ft; first 17 ft Armored.	\$1,114.72
RR-055/053X065	4000-7946 Equip., Servo ACS type Defect Detector (Hot Box) Cable Overall Length: 65 ft; first 53 ft Armored.	\$1,022.36
RR-055/057X065	4000-7946 Equip., Servo ACS type Defect Detector (Hot Box) Cable Overall Length: 65 ft; first 57 ft Armored.	\$1,031.56
RR-056/017X065	Servo CyberScan type Defect Detector (Hot Box) Cable; Overall Length: 65 ft; first 17 ft Armored.	\$897.30
RR-056/017X085	Servo CyberScan type Defect Detector (Hot Box) Cable; Overall Length: 85 ft; first 17 ft Armored.	\$999.93
RR-056/017X100	Servo CyberScan type Defect Detector (Hot Box) Cable; Overall Length: 100 ft; first 17 ft Armored.	\$1,076.90
RR-063/015X016.5	4000-7554-2 Equip., Servo ACS type Defect Detector (Hot Box) Cable; Length - 15 ft Armor, 16.5 Ft Cable	\$725.36
RR-063/053X065	4000-7554-2 Equip., Servo ACS type Defect Detector (Hot Box) Cable; Length - 53 ft Armor, 65 Ft Cable	\$994.16
RR-063/057X065	4000-7554-2 Equip., Servo ACS type Defect Detector (Hot Box) Cable; Length - 57 ft Armor, 65 Ft Cable	\$1,003.38
RR-063/063X065	4000-7554-2 Equip., Servo ACS type Defect Detector (Hot Box) Cable; Length - 63 ft Armor, 65 Ft Cable	\$1,072.43

RAILROAD PRODUCTS



RR-099



RR-100



RR-101

SERVO HOT BOX CABLES

Product #	Description	Price
RR-083	Defect Detector Controller Module External Antenna RF Cable, BNC/m + UHF/m; Length: 48"	\$16.19
RR-084	Defect Detector Controller Module External Antenna RF Cable, RG142, N/m + UHF/m Length: 36"	\$9.36
RR-090/015X116	Servo ACS type Defect Detector (Hot Box) Cable, Open one End, Overall Length: 116 ft; first 15 ft Armored.	\$1,176.73
RR-099/010	4000-6838 Equiv. Servo ACS Type Defect Detector Scanner Pyro Adaptor Cable, 200V -12/24V; Length: 10"	\$141.23
RR-100/068	4000-56, 4000-76 Equiv.; Controller Module to Junction Box Scanner Cable; Length: 68'	\$401.65
RR-100/100	4000-56, 4000-76 Equiv.; Controller Module to Junction Box Scanner Cable; Length: 100'	\$424.71
RR-101/100	4000-16 Equiv.; Controller Module to Junction Box Transducer Cable; Length: 100'	\$377.53
RR-134	Hot Box Cable, 18 AWG, Stranded, 5 Cond. to Soft Shell 15 pos connector; Length: 60"	\$16.16
RR-142/1440	Bungalo to Chopper Cable; Length: 120'	\$293.23
BNSF6KS-002	Hot Box Cable, 18 AWG Stranded, 5 Cond. To soft shell 15 pos connector; Length—60"	\$12.06

VLCC SPECIALIZED CABLES

Product #	Description	Price
RR-057	11-11310-oE, VGPIO Cable, 16AWG; 20 FT. (Vital Harmon Logic Controller Cable: VLCC)	CALL
RR-058	11-11362-oE, NVIO Cable, 16AWG, 20 Ft. (Vital Harmon Logic Controller Cable: VLCC)	CALL
RR-059	11-11308-oE, VSD Cable, 16AWG; 20 FT. (Vital Harmon Logic Controller Cable: VLCC)	CALL
RR-060	11-11313-oE, VGPI Cable, 16AWG; 20 FT. (Vital Harmon Logic Controller Cable: VLCC)	CALL
RR-061	11-113150-oE CCI Cable, Length - 6 Ft. (Vital Harmon Logic Controller Cable: VLCC)	CALL



RR-057

NEXT GENERATION (NGEN) ATX

WABTEC SPECIALIZED ITEMS

Product #	Description	Price
RR-080	Multi-port Extender Test Cable for NGEN ATX. Length 4 foot. a/k/a Octopus. Radio/Processor Assembly Extender Cable. Will also function with the RRP-330 Bench Charger with data test port. (See below).	\$65.76
RR-107	<p>Breakout Box for NGEN Transceiver. The RR-107 includes radio models 15623 (the -07,-09, ES, ATX First Generation ETDs), Model 15622 (Wabtec LCU-07), and the 23660 (NGEN) when using a RR-147 adapter.</p> <p>The RR-107 allows a repair technician to bench test and troubleshoot the Wabtec 11937 RF Board, 11980 and 11956 microprocessor boards used in Wabtec End of Train and Head of Train units. These boards are used in the following radio models: Wabtec 15623 and 23660 EOT radio transceivers and the 15622 HTD radio transceivers including both stand-alone and integrated models.</p> <p>The RR-107 box breaks out DC power connections, input/output audio signals for testing, includes the 2W/8W power control switch, the F1/F2 channel select switch, and provides a properly filtered sinad test point. Accessories include the RR-108 Serial Cable, the RR-110 board extender cable, and the RR147 adapter cable.</p>	\$172.37
RR-108	Serial Connector Cable for Wabtec 15622, 15623 & 23660 Radios with RSSI Test Point (BNC/f). Length 4 foot. Needed to connect your pc to the micro control board to set soft adjustments.	\$28.29
RR-110	RF to Processor Board Extender Cable for Wabtec 23660, 15622 & 15623 Radios. Length 12 inches.	\$85.09
RR-123/036RA	3174 Belden; SMB/plug-right angle+BNC/male. Length 36 inches.	\$16.08
RR-137	<p>Universal ETD Transceiver Test Box 7.5V/13.6V. Older TrainLink II Radios 15572. Connects to US & S Data radio, JSLM, Quantum DTX-442,Wabtec 15572, 15623, (23660 XCVR with Primus adapter) See RR-147. (Not HTD Radios.)</p> <p>The RR-137 will allow quick access to all of the Wabtec ETD radios for Sinad Test (FRA Calibration) by simply sliding the electronics up from the housing (about 3 inches) while the ETD is still connected to the battery and connecting the RR-137 box to the radio connector.</p>	\$83.73
RR-138	<p>Programming Cable. The programming cable will allow you to perform configuration programming and testing of a US & S ETD radio (the Data radio JSLM model series). This adapter interfaces the Data radio (JSLM) to a personal computer thru a RS232 serial port. Radio programming and radio control is performed through a PC running the Data radio JSLM programming application available free of charge from the Data radio web site.</p> <p>An advantage using the RR-138 the user does not have to purchase the expensive JSLM radio through US & S. This will allow the purchase of the same radio directly from Data radio and save cost by programming and quality check their work.</p>	\$82.99
RR-147/012	Adapter Cable for NGEN ATX Wabtec 23660 Radios to the RR-107 Breakout Box. HDB15/m + 6 pos. 1 row header. Fits RR-107 & RR137. Length – 12 inches.	\$19.52
RR-147/004	Adapter Cable for NGEN ATX Wabtec 23660 Radios to the RR-107 Breakout Box. HDB15/m + 6 pos. 1 row header. Fits RR-107 & RR137. Length – 4 inches.	\$15.86
<p><i>NOTE: To bench test the 15660 NGEN radio use the RR-147 adapter and the RR-137 Box.</i></p>		
RR-185	Use RR-147/004	
RRP-330	NGEN ATX Bench Charger. 110V to 24VDC. Single output. With Data Test Port.	\$432.64

ETD BATTERIES, CHARGERS, REAR END MARKER AND LANTERN BATTERIES**ETD BATTERIES —SEALED LEAD ACID**

Product #	Description	Price
LCR12V3.4P	Sealed lead acid. Original P/N LC-R123R4PU. Lo-Cap (Panasonic).	\$22.33
UB1250	Sealed lead acid. Original P/N LC-R125P is no longer available. Hi-Cap (Universal).	\$15.00
LC-R121R3PU	Sealed lead acid. Replacement for the ATX EOT (Panasonic).	\$17.75
UB1213	Sealed lead acid. Original P/N LC-R123R3PU. ATX EOT (Universal).	\$10.00
UB1280	Sealed lead acid. Original Pulse battery pack (Universal). Formerly UB1270.	\$11.08

ETD BATTERY CHARGER—NICAD

Product #	Description	Price
BC3603QC-EOT	iTech EOT NiCAD battery charger. Three unit, analyzer, conditioner and discharge modes. For use with US & S Nicad batteries. See also page 52.	\$760.00

REAR END MARKER BATTERIES

Product #	Description	Price
LCR12V17CP	Panasonic (original # LCR12V17CP Panasonic). Sealed lead acid, 12V, 17 AH, 20 HR	\$49.95
UB 12180	Universal Battery (original #LCR12V17CP Panasonic). Sealed lead acid, 12V, 17AH, 20 HR	\$30.00

LANTERN BATTERY (RECHARGEABLE)

Product #	Description	Price
UB650	Universal Battery with Spring Terminal. Sealed lead acid, 6V, 5.0 AH	\$9.75

LOBO TRADING ETD PARTS

Product #	Description	Price	Product #	Description	Price
5023V	Large Window Lexan	\$14.53	5761V	Small Window Lens Plate	\$12.21
5079V	Mary Plate	\$38.86	5788V	Stud Plate Long HVM	\$8.53
5079S	Stud for Mary Plate	\$3.65	5911V	Small Window Lexan	\$11.80
5519V	Gasket Battery	\$4.05	6468V	Antenna Donut	\$1.45
5608V	Gasket Antenna Lid	\$2.95	6587V	Bleed Valve	\$5.17

ETD AND MOBILE ANTENNAS

END OF TRAIN ANTENNAS

Product #	Description	Price
TTA450ES-2	COMPLETE ANTENNA FOR ES UNITS. Base, Antenna, Complete w/SMA Connector. Fits TRAINLINK ES series EOT.	\$137.50
TTA450II-2	COMPLETE ANTENNA FOR TRAINLINK II. Fits TRAINLINK II.	\$137.50
TTASPNR-2C	TOOLS NEEDED: Spanner Wrench	\$32.65
TTABIT	TOOLS NEEDED: Stepbit (For drilling lid hole 5/8")	\$35.65
TTARFA	OPTIONAL ITEM: RF ADAPTER. Test RX & TX measurements via NMO mount.	\$43.25
TTABASEES	REPLACEMENT PARTS FOR ES SERIES: Base only.	\$92.50
TTANUT	REPLACEMENT PARTS FOR ES SERIES: Hex nut only (nickel plated)	\$4.50
TTACOIL-ES/II	REPLACEMENT PARTS FOR ES SERIES: EOT Antenna coil replacement for "ES"; EOT antenna coil replacement for "TRAINLINK II"	\$56.25

MOBILE ANTENNA



The new Premier Series UHF mobile antenna is a premium quality mobile antenna engineered and built for the most discriminating end user.



PMUA-4252

While most use a helical wound format, Premier Antennas chose to be different. This Antenna is designed to be absolutely the best in bandwidth, tops in sensitivity, unmatched swr across the entire band, and above all, reliable.

Features include a dc short circuit for superior radio protection and ultra low noise performance.

Minimum bandwidth of 100 MHz covering 420-520 MHz is sure to cover most communication needs utilizing one model of antenna instead of several.

High impact radome and watertight housing will protect the antenna even in the harshest environments.

Utilizing state-of-the-art technology and providing broadband performance, the Premier UHF mobile antenna is the best choice for low profile applications.

Automobiles, buses, trucks, construction equipment, trains, agriculture, telemetry, and vending are just a few of the examples of where the Premier series antenna will feel right at home.

Compare Premier on different ground planes with other low profile antennas and you will see where Premiers' broadband stability outperforms the competition.

MOBILE ANTENNA

Product #	Description	Price
PMUA-4252	420-520 MHz (100 MHz Broadband) Low Profile Antenna	\$38.75

COMMUNICATIONS SERVICE MONITOR—RAMSEY COM3010



Service Monitor—Fully Loaded Duplex at a Sensible Price

The COM3010 is a full featured communications service monitor engineered and designed to provide highly accurate measurement and monitoring of communications equipment from 100kHz to 1.0GHz with 0.1ppm accuracy. Full duplex design enables independent and separate measurement and testing of transmitter and receiver circuits simultaneously making it the ideal service monitor for the radio technology of today...and tomorrow!

VALUE PACKED BUILT-IN FEATURES!

- ✓100kHz to 1.0GHz, Full Duplex
- ✓Built-in Power Meter & Dummy Load
- ✓Built-In Frequency Counter
- ✓Built-In Sweep Generator
- ✓Built-In SINAD Meter
- ✓Built-In Calibrated RSSI Meter
- ✓Built-In RS232 Control
- ✓Built-In Lithium Ion Battery Pack

SERVICE MONITOR

Product #	Description	Price
COM3010	Full Duplex Communications Service Monitor, 100kHz—1.0GHz, with one 1-hour Li-ion battery pack.	\$3995.00
BP3010	Additional Li-Ion Battery Pack, extends battery operation by one hour (Maximum 3 packs)	\$59.95
CC3010	Matching black padded Cordura® carrying case with strap	\$129.95

INFLATABLE LIGHTING

Primus offers Inflatable Lighting by Prism Lighting Services



Inflatable Lighting by Prism Lighting Services is now available at Primus. In just 30 seconds, you can inflate this portable lighting system and in as little as 3 minutes the best illuminating level is achieved.

Inflatable Lighting by Prism is light weight, foldable and portable. It can be carried in the back of a minivan or SUV and can be easily operated by an individual.

The PIL 1000 inflates to a maximum height of 15 feet from ground level and lights up an area of approximately 12,000 sq. yards, slightly under the size of two football fields.

The lighting system deflates and folds back easily in just 4 minutes. Multiple towers can be used to light up a large area. Can be used for a wide range of applications, including emergency lighting.

Base Dimensions: 27" x 25" x 27"; Weight: 55 lbs.; Lamp: Metal Halide 1000W; Brightness: 95000 Lumens



INFLATABLE LIGHT

Product #	Description	Price
PIL 1000	Prism Inflatable Light with 1000W Metal Halide Bulb	\$3,200.00

Visit us online at www.primuselectronics.com

SIGNAL BONDS (WELDED)

Joint Head Bonds, Welders and Molds

Joint Head Bonds are fabricated from cadmium bronze signal bond strand conductor. Conductor consists of flexible stranded conductors (133 wires) made in rope lay construction consisting of one center strand of 19 wires surrounded by 6 strands of 19 wires each, diameter as specified with commercial tolerances allowed. Makeup of finished bond strand is nominal 3/16" or 5/16" diameter.

- | | |
|-----------------------------------------------------------------------------------------------------------------------------------------------------------------------------------------------------------------------------------------------------------------------------------------------------------------------------------------------------------------------------------------------------------------------------------------------------------|--------------------------------------------------------------------------------------------------------------------------------------------------------------------------------------------------------------------------------|
| <ul style="list-style-type: none"> • 3/16" cadmium bronze bonds consist of strands of nominal 0.0125" diameter wire and 5/16" bonds consist of strands of nominal 0.0201" diameter wire • Cadmium bronze bond strand has a minimal tensile strength of 55 KSI. • Bonds manufactured from other types of conductors are available • Bonds are available in kits or separately • Call for Pricing | <p>Bond Kit Includes:</p> <ul style="list-style-type: none"> • (100) Bonds • (2) Replacement molds (left and right hand) • (200) Cartridges of weld metal • (1) Flint Igniter |
|-----------------------------------------------------------------------------------------------------------------------------------------------------------------------------------------------------------------------------------------------------------------------------------------------------------------------------------------------------------------------------------------------------------------------------------------------------------|--------------------------------------------------------------------------------------------------------------------------------------------------------------------------------------------------------------------------------|

JOINT HEAD BONDS—3/16" DIAMETER

3/16" Diameter Bonds: Bond Style	6-1/2" Part No.	7-1/2" Part No.	9-3/4" Part No.
XS Style			
Bond Kit	RBJHXS3/166.5KT	RBJHXS3/167.5KT	RBJHXS3/169.75KT
• Bond Only	RBJHXS3/166.5	RBJHXS3/167.5	RBJHXS3/169.75
• Molds Only (LH & RH)	RMJHXS3/16X	RMJHXS3/16X	RMJHXS3/16X
• Weld Metal	UWM25R	UWM25R	UWM25R
Head Free Rail			
Bond Kit	RBJHFR3/166.5KT	RBJHFR3/167.5KT	RBJHFR3/169.75KT
• Bond Only	RBJHFR3/166.5	RBJHFR3/167.5	RBJHFR3/169.75
• Molds Only (LH & RH)	RMJHFR3/16X	RMJHFR3/16X	RMJHFR3/16X
• Weld Metal	UWM25R	UWM25R	UWM25R
Tab Style (3/4")			
Bond Kit	RBJHTS3/166.5.KT	RBJHTS3/167.5KT	RBJHTS3/169.75KT
• Bond Only	RBJHTS3/166.5	RBJHTS3/167.5	RBJHTS3/169.75
• Molds Only (LH & RH)	RMJHTS3/16X	RMJHTS3/16X	RMJHTS3/16X
• Weld Metal	UWM25R	UWM25R	UWM25R
AREMA Reference No.	8130-1A	8130-1B	8130-1C

- RMJHXS3/16X includes RMJHXS3/16LHX AND RMJHXS3/16RHX
- Joint Head Bonds meet requirements of AREMA 8.1.30
- Ultraweld exothermic materials meet requirements of AREMA 8.1.34
- Tinned electroplated bond strand available

SIGNAL BONDS (WELDED)

JOINT HEAD BONDS—5/16” DIAMETER

5/16” Diameter Bonds: Bond Style	7” Part No.	9-3/4” Part No.	
Head Free Rail			<ul style="list-style-type: none"> Joint Head Bonds meet requirements of AREMA 8.1.30 Ultraweld exothermic materials meet requirements of AREMA 8.1.34 Tinned electroplated bond strand available
Bond Kit	RBJHFR5/167KT	RBJHFR5/169.75KT	
• Bond Only	RBJHFR5/167	RBJHFR5/169.75	
• Molds Only (LH & RH)	RMJHFR5/16X	RMJHFR5/16X	
• Weld Metal	UWM32R	UWM32R	
Tab Style (1”)			
Bond Kit	RBJHTS5/167KT	RBJHTS5/169.75KT	
• Bond Only	RBJHTS5/167	RBJHTS5/169.75	
• Molds Only (LH & RH)	RMJHTS5/16X	RMJHTS5/16X	
• Weld Metal	UWM32R	UWM32R	
AREMA Reference No.	8130-1D	8130-1E	

RAIL HEAD “DOUBLE” WELDERS—3/16” DIAMETER

3/16” Diameter Bonds: Bond Style	6-1/2” Part No.	7-1/2” Part No.	9-3/4” Part No.
XS Style			
Welder Only (molds & frame)	RMJHXS3/166.5T6	RMJHXS3/167.5T6	RMJHXS3/169.75T6
• Frame Only	RMJH6.5T6FRM	RMJH7.5T6FRM	RMJH9.75T6FRM
• Molds Only (LH & RH)	RMJHXS3/16X	RMJHXS3/16X	RMJHXS3/16X
• Bond Clips	BCLIP3/16	BCLIP3/16	BCLIP3/16
Head Free Rail			
Welder Only (molds & frame)	RMJHFR3/166.5T6	RMJHFR3/167.5T6	RMJHFR3/169.75T6
• Frame Only	RMJH6.5T6FRM	RMJH7.5T6FRM	RMJH9.75T6FRM
• Molds Only (LH & RH)	RMJHFR3/16X	RMJHFR3/16X	RMJHFRE/16X
• Bond Clips	BCLIP3/16	BCLIP3/16	BCLIP3/16
Tab Style (3/4”)			
Welder Only (molds & frame)	RMJHTS3/166.5T6	RMJHTS3/167.5T6	RMJHTS3/169.75T6
• Frame Only	RMJH6.5T6FRM	RMJH7.5T6FRM	RMJH9.75T6FRM
• Molds Only (LH & RH)	RMJHTS3/16X	RMJHTS3/16X	RMJHTS3/16X
• Bond Clips	BCLIP3/16	BCLIP3/16	BCLIP3/16
AREMA Reference No.	8130-1A	8130-1B	8130-1C

- Double welders provide a simple and portable means by which to install joint head bonds
- Ultraweld exothermic materials meet requirements of AREMA 8.1.34

Visit us online at www.primuselectronics.com

SIGNAL BONDS (WELDED)

RAIL HEAD “DOUBLE” WELDERS—5/16”

5/16” Diameter Bonds: Bond Style	7” Part No.	9-3/4” Part No.
Head Free Rail		
Welder Only (molds & frame)	RMJHFR5/167T6	RMJHFR5/169.75T6
• Frame Only	RMJH7T6FRM	RMJH9.75T6FRM
• Molds Only (LH & RH)	RMJHFR5/16X	RMJHFR5/16X
• Bond Clips	BCLIP5/16	BCLIP5/16
Tab Style (1”)		
Welder Only (molds & frame)	RMJHTS5/167T6	RMJHTS5/169.75T6
• Frame Only	RMJH7T6FRM	RMJH9.75T6FRM
• Molds Only (LH & RH)	RMJHTS5/16X	RMJHTS5/16X
• Bond Clips	BCLIP5/16	BCLIP5/16
AREMA Reference No.	8130-1D	8130-1E

- Ultraweld exothermic materials meet requirements of AREMA 8.1.34

RAIL HEAD “DOUBLE” WELDER COMPONENTS

Welder Component	Part No.
Frame only w/o Extension Bar	RMJHT6FNEB
Mold Mounts	RMJHT6MMKT
6-1/2” Extension Bar	RMJHT6EB6.5
7” Extension Bar	RMJHT6EB7
7-1/2” Extension Bar	RMJHT6EB7.5
9-3/4” Extension Bar	RMJHT6EB9.75

- Welder components can be purchased separately and are completely interchangeable. A given Welder can be configured for bonds of a different length by the use of a corresponding Extension Bar

**The complete line of Harger products is available from Primus Electronics.
Please call for availability and pricing.**

SIGNAL BONDS (WELDED)

RAIL HEAD “SINGLE” WELDERS

Bond Terminal Style	3/16” Part No.	5/16” Part No.
Head Free Rail		
Welder Pair (LH & RH molds & frames)	RMJHFR3/16T7	RMJHFR5/16T7
• Frame Only (LH & RH Pair)	RMJHT7FRM	RMJHT7FRM
• Molds Only (LH & RH Pair)	RMJHFR3/16X	RMJHFR5/16X
Tab Style (1”)		
Welder Pair (LH & RH molds & frames)	RMJHTS1-3/16T7	RMJHTS5/16T7
• Frame Only (LH & RH Pair)	RMJHT7FRM	RMJHT7FRM
• Molds Only (LH & RH Pair)	RMJHTS1-3/16X	RMJHTS5/16X
Tab Style (3/4”)		
Welder Pair (LH & RH molds & frames)	RMJHTS3/16T7	N/A
• Frame Only (LH & RH Pair)	RMJHT7FRM	N/A
• Molds Only (LH & RH Pair)	RMJHTS3/16X	N/A
XS Style (3/4”)		
Welder Pair (LH & RH molds & frames)	RMJHXS3/16T7	N/A
• Frame Only (LH & RH Pair)	RMJHT7FRM	N/A
• Molds Only (LH & RH Pair)	RMJHXS3/16X	N/A

- Rail Head “Single” Welders provide a means of attaching joint head bonds to the head of the rail when it is not convenient or possible to use a “Double” welder such as transposed rail and compromise joints
- Ultraweld exothermic materials meet requirements of AREMA 8.1.34

Track Circuit Connectors (Web)

Track Connectors are used when a compression connection is required, but the benefits of an exothermically welded connection are desired. Manufactured from 3/16” diameter cadmium bronze bond strand. Resists fatigue due to vibration and provides maximum flexibility. Track Connectors are available in kits or separately.

Call for pricing.

Track Connector Kit Includes:

- (100) Track Connector Bonds
 - (2) Replacement molds (left and right hand)
 - (100) Cartridges of weld metal
 - (1) Flint Igniter
-
- Track Circuit Connectors meet requirements of AREMA 8.1.32
 - Ultraweld exothermic materials meet requirements of AREMA 8.1.34
 - Track Connectors require a Web Welder for welding to the rail web and compression tool MCT81/0
 - Tinned electroplated bond strand available

3/16” DIAMETER TRACK CONNECTORS

Product No.	Description	Box Qty	Approx Box Wt. (lbs)
RBTC3/164KT	1” Tab x 4” Long Bootleg (Kit)	100	54
RBTC3/164	1” Tab x 4” Long Bootleg (Track Connector only)	50	17
RBTC3/1612KT	1” Tab x 12” Long Bootleg (Kit)	100	106
RBTC3/1612	1” Tab x 12” Long Bootleg (Track Connector only)	50	44

SIGNAL BONDS (WELDED)

COMPRESSION TOOL

Product No.	Description	Length	Approx. Wt. (lbs)
MCT81/0	Handy compression tool terminates copper compression connectors in wire sizes #8 through 1/0. Handle length facilitates two-handed crimps when necessary. Dies included.	10.5"	3

Jumper Bootleg and Switch Bonds (Web)

Bonds manufactured from 3/16" diameter cadmium bronze bond strand. Bonds are available in kits or separately. Mold (s) sold separately.

Call for pricing.

Bond Kit Includes:

- (100) Bonds
- (200) Cartridges of weld metal for Switch and Jumper Bonds
- (200) Cartridges of weld metal for Bootleg Bonds
- (1) Flint Igniter

3/16" DIAMETER BONDS

End Style	Jumper Part No.	Bond Type Bootleg Part No.	Switch Part No.
XS Style (3/4")			
• Bond Kit	RBJPXS3/16KT"L"	RBBLXS3/16KT"L"	RBSWXS3/16KT"L"
• Bond Only	RBJPXS3/16"L"	RBBLXS3/16"L"	RBSWXS3/16"L"
Tab Style (3/4")			
• Bond Kit	RBJPTS.75-3/16KT"L"	RBBLTS.75-3/16KT"L"	RBSWTS.75-3/16KT"L"
• Bond Only	RBJPTS.75-3/16"L"	RBBLTS.75-3/16"L"	RBSWTS.75-3/16"L"
Tab Style (1")			
• Bond Kit	RBJPTS1-3/16KT"L"	RBBLTS1-3/16KT"L"	RBSWTS1-3/16KT"L"
• Bond Only	RBJPTS1-3/16"L"	RBBLTS1-3/16"L"	RBSWTS1-3/16"L"
Tab Style (1-1/2")			
• Bond Kit	RBJPTS1.5-3/16KT"L"	RBBLTS1.5-3/16KT"L"	RBSWTS1.5-3/16KT"L"
• Bond Only	RBJPTS1.5-3/16"L"	RBBLTS1.5-3/16"L"	RBSWTS1.5-3/16"L"

5/16" DIAMETER BONDS

End Style	Jumper Part No.	Bond Type Bootleg Part No.	Switch Part No.
Tab Style (1")			
• Bond Kit	RBJPTS1-5/16KT"L"	RBBLTS1-5/16KT"L"	RBSWTS1-5/16KT"L"
• Bond Only	RBJPTS1-5/16"L"	RBBLTS1-5/16"L"	RBSWTS1-5/16"L"

- Substitute desired bond length in inches for "L"
- Bonds meet requirements of AREMA 8.1.32
- Tinned electroplated bond strand available

SIGNAL BONDS (WELDED)

FIELD MADE TAB STYLE BONDS

Bond Conductor	Tab Length	Sleeves Part No.	Box Qty.	Hammer Die Part No.	Weld Metal	Box Qty.
#6 Solid	1"	BSLV6X1	100	N/A	UWM25R	25
3/16" Bond Strand	3/4"	BSLV3/16X.75	100	HMDIE3/16	UWM25R	25
3/16" Bond Strand	1"	BSLV3/16X1	100	HMDIE3/16	UWM25R	25
3/16" Bond Strand	1-1/2"	BSLV3/16X1.5	100	HMDIE3/16	UWM25R	25
5/16" Bond Strand	1"	BSLV5/16X1	100	HMDIE5/16	UWM25R	25

- Bonds can be fabricated in the field by using Harger's easy to use Hammer Dies
- Bond conductor is available

WEB BOND WELDERS & MOLDS

Bond Terminal Style	3/16" Part No.	5/16" Part No.
Tab Style (3/4")		
Welder Pair (LH & RH molds & frames)	RMWTS.75-3/16T21	N/A
• Frame Only	RMWT21FRM	
• Mold Only (LH & RH Pair)	RMWTS.75-3/16X	
Tab Style (1")		
Welder Pair (LH & RH molds & frames)	RMWTS1-3/16T21	RMWTS1-5/16T21
• Frame Only	RMWT21FRM	RMWT21FRM
• Mold Only (LH & RH Pair)	RMWTS1-3/16X	RMWTS1-5/16X
Tab Style (1-1/2")		
Welder Pair (LH & RH molds & frames)	RMWTS1.5-3/16T21	N/A
• Frame Only	RMWT21FRM	
• Mold Only (LH & RH Pair)	RMWTS1.5-3/16X	
XS Style (3/4")		
Welder Pair (LH & RH molds & frames)	RMWS3/16T21	N/A
• Frame Only	RMWT21FRM	
• Mold Only (LH & RH Pair)	RMWXS3/16X	

- Web Welders are used for factory or field made bonds including Track Connectors, Jumper, Bootleg and Switch Bonds
- For track circuits and jumper bonds welded to the neutral axis of the rail
- Welders and Molds are only supplied in pairs
- Frame only is a single unit
- Ultraweld exothermic materials meet requirements of AREMA 8.1.34

Visit us online at www.primuselectronics.com

SIGNAL BONDS (WELDED)

BOND STRAND

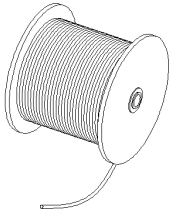

Product No.	Description	Unit of Measure
3/16CBWB	3/16 Cadmium Bronze Wire, Bare, 7 x 19 x 0.0125 Alloy 162	Ft.
3/16TCBWB	3/16 Tinned Cadmium Bronze Wire, Bare, 7 x 19 x 0.0125 Alloy 162	Ft.
5/16CBWB	5/16 Cadmium Bronze Wire, Bare, 7 x 19 x 0.0201 Alloy 162	Ft.
5/16TCBWB	5/16 Tinned Cadmium Bronze Wire, Bare, 7 x 19 x 0.0201 Alloy 162	Ft.

CABLE GUARDS

Product No.	Color	Approx. Wt. Each (lbs)	Box Qty.	Approx. Wt. Box (lbs)
321B	Black	1	5	6-1/2
321G	Gray	1	5	6-1/2

- 1/2" x 8' extruded thermo plastic cable guard with flanges provides concealment and protection for cables and down conductors

The complete line of Harger products is available from Primus Electronics. In addition to Harger, we also offer products from over 100 manufacturers. For a complete listing of manufacturers, please refer to the inside back cover of this catalog. We are always adding quality lines to our line card.

This catalog represents some of the most popular Railroad products available through Primus. If you can not find the item you are looking for, please contact one of our sales representatives at (800) 435-1636 or the Railroad Division Manager, Jack McNutt at (888) 303-7245 or jack@emr.net

SIGNAL HUT GROUNDING

ALUMINUM TO COPPER GROUND STUDS

Product No.	Description	Approx. Wt. (lbs)
ASCACGS6SX36	ASC Al-Cu Ground Stud w/ #6 sol x 3' lg.	0.8
ASCACGS6SX48	ASC Al-Cu Ground Stud w/ #6 sol x 4' lg.	0.9
ASCACGS6SX60	ASC Al-Cu Ground Stud w/ #6 sol x 5' lg.	1.0
ASCACGS6SX72	ASC Al-Cu Ground Stud w/ #6 sol x 6' lg.	1.1

- Aluminum to Copper Bond Stud provides a permanent ground connection to aluminum signal bungalows and eliminates corrosion between copper and aluminum
- Aluminum plate of the ground stud is GTAW or MGAW welded to the aluminum structure and the copper pigtail wire is exothermically welded to the ground electrode system

STEEL SIGNAL CASE GROUND PLATES

Product No.	Description	Steel	Approx. Wt. (lbs)
SSCGP6SX36	Steel Signal Case Ground Plate w/ #6 sol 3' lg.	Mild Carbon	0.9
SSCGP6SX48	Steel Signal Case Ground Plate w/ #6 sol 4' lg.	Mild Carbon	1.0
SSCGP6SX60	Steel Signal Case Ground Plate w/ #6 sol 5' lg.	Mild Carbon	1.1
SSCGP6SX72	Steel Signal Case Ground Plate w/ #6 sol 6' lg.	Mild Carbon	1.2
SSCGP6SX36SS	Steel Signal Case SS Ground Plate w/ #6 sol 3' lg.	300 Series SS	0.9
SSCGP6SX48SS	Steel Signal Case SS Ground Plate w/ #6 sol 4' lg.	300 Series SS	1.0
SSCGP6SX60SS	Steel Signal Case SS Ground Plate w/ #6 sol 5' lg.	300 Series SS	1.1
SSCGP6SX72SS	Steel Signal Case SS Ground Plate w/ #6 sol 6' lg.	300 Series SS	1.2

- For grounding steel signal huts and enclosures
- Steel plates measure 1/4" x 2" x 2"

FEEDTHROUGH STUD

Product No.	Description	Approx. Wt. (lbs)
ASCFS72	ASC Feedthrough Stud w/ #6 sol x 6' lg.	0.8

- Feedthrough Stud provides a convenient and permanent path for a ground conductor to pass through the wall of a structure
- Stainless steel and tinned materials ensure resistance to corrosion
- Protruding stud is used to either exothermically weld a ground conductor using Ultraweld mold HRCAD1/46SB (UWM45) or make a bolted lug connection

Visit us online at www.primuselectronics.com

ULTRAWELD CONNECTIONS

Ultraweld Process

The Ultraweld process is an effective and safe method of welding copper to copper or copper to steel for the purpose of producing permanent electrical connections. Ultraweld exothermically welded connections are produced from the energy and molten copper metal liberated from an exothermic reaction between powdered copper oxide and aluminum. The reaction takes place at a theoretical temperature of 4600°F and as a result, molten copper alloy is created and used to melt the conductors and cast the finished connection.

The exothermic reaction takes place in a semi-permanent graphite mold that will last 50 or more welds if properly cared for. The process is simple and easy to implement providing an on-site means to make welded electrical connections without requiring external power, equipment or the special training usually required for brazing and welding.

The process will provide a finished connection that will never corrode, loosen or increase in resistance. The finished connection also provides an ampacity that exceeds that of the conductors being joined.

Mold Numbering System

The part number give, in code, the complete information of the mold.

- Type of connection, conductor size (s) and mold price key

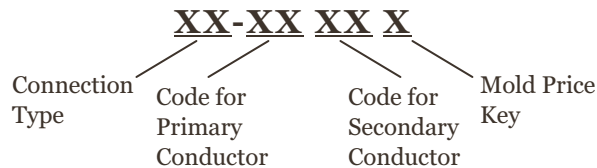

Examples

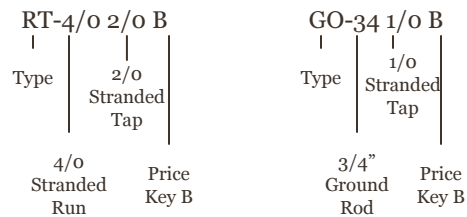

CABLE TO CABLE ULTRAWELD CONNECTIONS

Mold Information:

- Molds listed are for stranded cable. For solid conductor, add suffix "S" after conductor number (i.e. 4S = 4 AWG solid conductor)
- Price Key is the **bold letter** in the Mold Part No.
- Molds with Price Key "L", "A", or "M" are sold with handles. If handles not required, add suffix "-X" after the Mold Part No.
- Handles for "L", "A", and "M" Price Key molds do not include flint igniters
- For mold Ware Plates, add suffix "WP" to the end of the Mold Part No.

Required Tools & Accessories:

MH1—Handle for "B" and "K" Price Key Molds

MH2—Handle for "C" and "D" Price Key Molds

FLTIG—Flint Igniter when Price Key is "L", "A", or "M"

Recommended Tools & Accessories:

CCBRSH1—Card Cloth Brush

MCBRSH1—Mold Cleaning Brush

PB (PARALLEL BUTT) CONNECTION TYPE

Cable Size Run	Cable Size Tap	Mold Part No.	Weld Metal
	#6 Sol	PB-6S6SB	UWM25
#6 Sol	3/16	PB-6S3/16B	UWM25
	5/16	PB-6S5/16B	UWM32
3/16	#6 Sol	PB-3/166SB	UWM25
	3/16	PB-3/163/16B	UWM25
	#8 Sol	PB-48SB	UWM32
#4	#6 Sol	PB-46SB	UWM32
	#6	PB-46B	UWM32
	#4	PB-44B	UWM32
#2 Sol	#2 Sol	PB-2S2SB	UWM65
	#8 Sol	PB-28SB	UWM32
	#6 Sol	PB-26SB	UWM32
#2	#6	PB-26B	UWM32
	#4	PB-24B	UWM45
	#2	PB-22B	UWM65

CABLE TO CABLE ULTRAWELD CONNECTIONS

BS (BUTT SPLICE) CABLE CONNECTION TYPE

Cable Size	Mold Part No.	Weld Metal
#6 Sol	BS-6SL	UWM25
#6	BS-6L	UWM25
3/16	BS-3/16L	UWM25
#4	BS-4L	UWM25
#3	BS-3L	UWM32
#2	BS-2L	UWM32
#1	BS-1L	UWM32
1/0	BS-1/0B	UWM45
2/0	BS-2/0B	UWM65
3/0	BS-3/0B	UWM90
4/0	BS-4/0B	UWM90
250 MCM	BS-25CMB	UWM115
300 MCM	BS-3CMB	UWM115
350 MCM	BS-35CMB	UWM150
500 MCM	BS-5CMB	UWM200
750 MCM	BS-75CMC	2-UWM150
1000 MCM	BS-1MMC	2-UWM200

PS (PARALLEL SPLICE) CONNECTION TYPE

Cable Size Run/ Tap	Mold Part No.	Weld Metal
#8 Sol	PS-8S8SL	UWM15
#8	PS-88L	UWM15
#6 Sol	PS-6S6SL	UWM25
#6	PS-66L	UWM25
3/16	PS-3/163/16L	UWM25

Please call for availability and pricing.

PT (PARALLEL THRU) CABLE CONNECTION TYPE

Cable Size Run	Cable Size Tap	Mold Part No.	Weld Metal
#6 Sol	#6 Sol	PT-6S6SB	UWM25
	3/16	PT-6S3/16B	UWM25
#6	#6	PT-66B	UWM25
3/16	#6 Sol	PT-3/166SB	UWM25
	3/16	PT-3/163/16B	UWM25
	#8 Sol	PT-48SB	UWM32
	#8	PT-48B	UWM32
#4	#6 Sol	PT-46SB	UWM32
	#6	PT-46B	UWM32
	#4	PT-44B	UWM32
#2 Sol	#2 Sol	PT-2S2SB	UWM65
	#8 Sol	PT-28SB	UWM45
	#8	PT-28B	UWM45
#2	#6 Sol	PT-26SB	UWM45
	#6	PT-26B	UWM45
	#4	PT-24B	UWM65
	#2	PT-22B	UWM65
	#8 Sol	PT-2/08SB	UWM65
	#8	PT-2/08B	UWM65
	#6 Sol	PT-2/06SB	UWM90
	#6	PT-2/06B	UWM90
2/0	#4	PT-2/04B	UWM90
	#2	PT-2/02B	UWM90
	#1	PT-2/01B	UWM90
	1/0	PT-2/01/0B	UWM115
	2/0	PT-2/02/0B	UWM115
	#8 Sol	PT-4/08SB	UWM90
	#8	PT-4/08B	UWM90
	#6 Sol	PT-4/06SB	UWM90
	#6	PT-4/06B	UWM90
	#4	PT-4/04B	UWM150
4/0	#2	PT-4/02B	UWM150
	#1	PT-4/01B	UWM150
	1/0	PT-4/01/0B	UWM150
	2/0	PT-4/02/0B	UWM150
	3/0	PT-4/03/0B	UWM200
	4/0	PT-4/04/0B	UWM200

CABLE TO CABLE ULTRAWELD CONNECTIONS

RT (RUN & TAP) CONNECTION TYPE

Cable Size Run	Cable Size Tap	Mold Part No.	Weld Metal
#6 Sol	#6 Sol	RT-6S6SB	UWM32
	3/16	RT-6S3/16B	UWM32
#6	#6	RT-66B	UWM32
3/16	#6 Sol	RT-3/166SB	UWM32
	3/16	RT-3/163/16B	UWM32
#4	#4	RT-44B	UWM32
#2 Sol	#2 Sol	RT-2S2SB	UWM45
#2	#4	RT-24B	UWM45
	#2	RT-22B	UWM45
#1	#4	RT-14B	UWM45
	#2	RT-12B	UWM45
	#1	RT-11B	UWM45
1/0	#4	RT-1/04B	UWM45
	#2	RT-1/02B	UWM45
	#1	RT-1/01B	UWM45
	1/0	RT-1/01/0B	UWM90
2/0	#4	RT-2/04B	UWM45
	#2	RT-2/02B	UWM45
	#1	RT-2/01B	UWM45
	1/0	RT-2/01/0B	UWM90
	2/0	RT-2/02/0B	UWM90
3/0	#4	RT-3/04B	UWM45
	#2	RT-3/02B	UWM45
	#1	RT-3/01B	UWM45
	1/0	RT-3/01/0B	UWM90
	2/0	RT-3/02/0B	UWM90
4/0	3/0	RT-3/03/0B	UWM115
	#4	RT-4/04B	UWM90
	#2	RT-4/02B	UWM90
	#1	RT-4/01B	UWM90
4/0	1/0	RT-4/01/0B	UWM90
	2/0	RT-4/02/0B	UWM90
	3/0	RT-4/03/0B	UWM115
	4/0	RT-4/04/0B	UWM150

Mold Information:

- Molds listed are for stranded cable. For solid conductor, add suffix “S” after conductor number (i.e. 4S = 4 AWG solid conductor)
- Price Key is the **bold letter** in the Mold Part No.
- Molds with Price Key “L”, “A”, or “M” are sold with handles. If handles not required, add suffix “-X” after the Mold Part No.
- Handles for “L”, “A”, and “M” Price Key molds do not include flint igniters
- For mold Ware Plates, add suffix “WP” to the end of the Mold Part No.

Required Tools & Accessories:

MH1—Handle for “B” and “K” Price Key Molds

MH2—Handle for “C” and “D” Price Key Molds

FLTIG—Flint Igniter when Price Key is “L”, “A”, or “M”

Recommended Tools & Accessories:

CCBRSH1—Card Cloth Brush

MCBRSH1—Mold Cleaning Brush

**Primus Electronics is a Full Line
Harger Distributor.**

**For product information, pricing
and availability please contact a
Primus Sales Representative at
(800) 435-1635**

CABLE TO GROUND ROD ULTRAWELD CONNECTIONS

**GD (GROUND ROD TO DEAD END)
CABLE CONNECTION TYPE**

Ground Rod Size	Cable Size	Mold Part No.	Weld Metal
1/2"	#6	GD-126L	UWM25
	#4	GD-124L	UWM25
	#2	GD-122B	UWM65
	2/0	GD-122/0B	UWM90
	4/0	GD-124/0B	UWM90
5/8"	#6	GD-586L	UWM32
	#4	GD-584L	UWM32
	#2 Sol	GD-582SB	UWM32
	#2	GD-582B	UWM65
	1/0	GD-581/0B	UWM90
	2/0	GD-582/0B	UWM90
	4/0	GD-584-0/B	UWM90
	250 MCM	GD-5825CMB	UWM90
3/4"	#6	GD-346L	UWM32
	#4	GD-344L	UWM45
	#2 Sol	GD-342SB	UWM90
	#2	GD-342B	UWM90
	1/0	GD-341/0B	UWM90
	2/0	GD-342/0B	UWM90
	4/0	GD-344/0B	UWM90
	250 MCM	GD-3425CMB	UWM90
1"	2/0	GD-102/0B	UWM150
	4/0	GD-104/0B	UWM150
	250 MCM	GD-1025CMB	UWM150

**GO (GROUND ROD TO CABLE OVER
TOP) CONNECTION TYPE**

Ground Rod Size	Cable Size	Mold Part No.	Weld Metal
1/2"	#6	GO-126L	UWM32
	#4	GO-124L	UWM32
	#2	GO-122B	UWM90
	2/0	GO-122/0B	UWM90
	4/0	GO-124/0B	UWM115
5/8"	#6	GO-586L	UWM32
	#4	GO-584L	UWM32
	#2 Sol	GO-582SB	UWM90
	#2	GO-582B	UWM90
	1/0	GO-581/0B	UWM90
	2/0	GO-582/0B	UWM115
	4/0	GO-584-0/B	UWM115
	250 MCM	GO-5825CMB	UWM150
3/4"	#6	GO-346M	UWM45
	#4	GO-344M	UWM65
	#2 Sol	GO-342SB	UWM90
	#2	GO-342B	UWM90
	1/0	GO-341/0B	UWM115
	2/0	GO-342/0B	UWM115
	4/0	GO-344/0B	UWM115
	250 MCM	GO-3425CMB	UWM150
1"	2/0	GO-102/0B	UWM150
	4/0	GO-104/0B	UWM150
	250 MCM	GO-1025CMB	UWM200

- Molds listed are for copper-clad steel ground rods
- For welding to full size copper-clad steel, stainless steel, galvanized steel or solid copper ground rods, add letter "F" to ground rod size

UNI-SHOTS ULTRAWELD CONNECTIONS

UNI-SHOTS G11, G21, G31

Type	Mold	Ground Rod Size	Cable Size Solid	Cable Size Stranded
G11	G11-588	5/8"	#6, #8	#8
G11	G11-584	5/8"	#3, #4	#4, #6
G11	G11-582	5/8"	#1, #2	#2, #3
G11	G11-581/0	5/8"	2/0, 1/0	1/0, #1
G11	G11-582/0	5/8"	-	2/0
G11	G11-348	3/4"	#6, #8	#8
G11	G11-344	3/4"	#3, #4	#4, #6
G11	G11-342	3/4"	#1, #2	#2, #3
G11	G11-341/0	3/4"	2/0, 1/0	1/0, #1
G11	G11-342/0	3/4"	-	2/0
G21	G21-588	5/8"	#6, #8	#8
G21	G21-584	5/8"	#3, #4	#4, #6
G21	G21-582	5/8"	#1, #2	#2, #3
G21	G21-581/0	5/8"	2/0, 1/0	1/0, #1
G21	G21-348	3/4"	#6, #8	#8
G21	G21-344	3/4"	#3, #4	#4, #6
G21	G21-342	3/4"	#1, #2	#2, #3
G21	G21-341/0	3/4"	2/0, 1/0	1/0, #1
G31	G31-588	5/8"	#6, #8	#8
G31	G31-584	5/8"	#3, #4	#4, #6
G31	G31-582	5/8"	#1, #2	#2, #3
G31	G31-581/0	5/8"	2/0, 1/0	1/0, #1
G31	G31-348	3/4"	#6, #8	#8
G31	G31-344	3/4"	#3, #4	#4, #6
G31	G31-342	3/4"	#1, #2	#2, #3
G31	G31-341/0	3/4"	2/0, 1/0	1/0, #1

- Disposable single use ceramic mold provides convenience and ease of use
- Packaged 12 per box
- Requires only a Flint Igniter (FLTIG) to make a connection
- No frames or handle clamps are required

CABLE TO STEEL SURFACE / PIPE ULTRAWELD CONNECTIONS

HB (HORIZONTAL BUTT OFF SURFACE) CONNECTION TYPE

Cable Size	Mold Part No.	Weld Metal
#2 Sol	HB-2SB	UWM65
#2	HB-2B	UWM65
2/0	HB-2/0B	UWM90
4/0	HB-4/0B	UWM115
250 MCM	HB-25CMB	UWM115

HD (HORIZONTAL BUTT DOWN ON SURFACE) CONNECTION TYPE

Cable Size	Mold Part No.	Weld Metal
#6 Sol	HD-6SA	UWM45
#6	HD-6A	UWM65
#4	HD-4A	UWM45
#2 Sol	HD-2SA	UWM45
#2	HD-2A	UWM45
2/0	HD-2/0B	UWM90

HB (HORIZONTAL BUTT OFF SURFACE) PIPE CONNECTION TYPE

Cable Size	Mold Part No.	Weld Metal
2/0	HB-2/0**B	UWM90
3/0	HB-3/0**B	UWM115
4/0	HB-4/0**B	UWM115
250 MCM	HB-25CM**B	UWM115

** Add pipe size to Mold Part No. (see chart below)

HD (HORIZONTAL BUTT DOWN ON SURFACE) PIPE CONNECTION TYPE

Cable Size	Mold Part No.	Weld Metal
#6	HD-6**A	UWM45
#4	HD-4**A	UWM45
#2	HD-2**A	UWM45
#1	HD-1**A	UWM65

** Add pipe size to Mold Part No. (see chart below)

CABLE TO HORIZONTAL STEEL PIPE (HB & HD)

Cable	Nominal Pipe Size	Pipe Size Indicator
#1 and Smaller	12" and Smaller	Nominal Pipe Size*
#1 and Smaller	14" and Larger	None
1/0 thru 250	28" and Smaller	Nominal Pipe Size*
1/0 thru 250	30" and Larger	None

Use Mold Part No. with Pipe Size (**) Indicator — Example: #6 cable to 2-1/2" pipe = HB-62.5B

For product information, pricing and availability please contact a Primus Sales Representative at (800) 435-1635 or sales@primuselectronics.com

Visit us online at www.primuselectronics.com

CABLE TO STEEL SURFACE / PIPE ULTRAWELD CONNECTIONS

VA (VERTICAL ANGLE 45°) CONNECTION TYPE

Cable Size	Mold Part No.	Weld Metal
#6	VA-6 B	UWM45
#4	VA-4 B	UWM45
#2 Sol	VA-2 SB	UWM45
#2	VA-2 B	UWM45
2/0	VA-2/0 B	UWM90
4/0	VA-4/0 B	UWM115
250 MCM	VA-25 CMB	UWM115

When welding to pipe use CSKIT chain support for mounting

VD (VERTICAL DOWN) CONNECTION TYPE

Cable Size	Mold Part No.	Weld Metal
#6	VD-6 B	UWM45
#4	VD-4 B	UWM65
#2 Sol	VD-2 SB	UWM65
#2	VD-2 B	UWM65
2/0	VD-2/0 B	UWM115
4/0	VD-4/0 B	UWM150
250 MCM	VD-25 CMB	UWM200

When welding to pipe use CSKIT chain support for mounting

VA (VERTICAL ANGLE 45°) PIPE CONNECTION TYPE

Cable Size	Mold Part No.	Weld Metal
#6	VA-6** B	UWM45
#4	VA-4** B	UWM45
#2 Sol	VA-2S** B	UWM45
#2	VA-2** B	UWM45
2/0	VA-2/0** B	UWM90
4/0	VA-4/0** B	UWM115

** Add Horizontal or Vertical pipe orientation and pipe size indicator (see chart below)

VD (VERTICAL DOWN) PIPE CONNECTION TYPE

Cable Size	Mold Part No.	Weld Metal
#6	VD-6** B	UWM45
#4	VD-4** B	UWM65
#2 Sol	VD-2S** B	UWM65
#2	VD-2** B	UWM65
2/0	VD-2/0** B	UWM115
4/0	VD-4/0** B	UWM150
250 MCM	VD-25CM** B	UWM200

** Add Horizontal or Vertical pipe orientation and pipe size indicator (see chart below)

CABLE TO VERTICAL STEEL PIPE

Cable	Nominal Pipe Size	Pipe Size Indicator
#6 thru 250	30" and Smaller	Nominal Pipe Size*
#6 thru 250	32" and Larger	None

Use Mold Part No.; add "V" and Pipe Size (**) Indicator—
Example: #2 cable to 2-1/2" pipe = VA-2V2.5**B**

CABLE TO HORIZONTAL STEEL PIPE

Use Mold Part No.; add "H" and Pipe Size (**) Indicator—
Example: #2/0 cable to 6" pipe = VA-2/0H6**B**

Mold Information:

- Molds listed are for stranded cable. For solid conductor, add suffix "S" after conductor number (i.e. 4S = 4 AWG solid conductor)
- Price Key is the **bold letter** in the Mold Part No.

Required Tools & Accessories:

CSH1—Chain Support Handle Clamp for "B" Price Key Molds **OR**

MH1—Mold Handle for "B" Price Key Molds **AND**

CSKIT—Chain Support Kit

Recommended Tools & Accessories:

CCBRSH1—Card Cloth Brush

MCBRSH1—Mold Cleaning Brush

CABLE TO STEEL SURFACE ULTRAWELD CONNECTIONS

VH (VERTICAL SURFACE HORIZONTAL) CABLE CONNECTION TYPE

Cable Size	Mold Part No.	Weld Metal
#6	VH-6B	UWM65
#4	VH-4B	UWM65
#2 Sol	VH-2SB	UWM65
#2	VH-2B	UWM65
2/0	VH-2/0B	UWM115
4/0	VH-4/0B	UWM150
250 MCM	VH-25CMB	UWM150

VT (VERTICAL THRU ON VERTICAL SURFACE) CONNECTION TYPE

Cable Size	Mold Part No.	Weld Metal
#6	VT-6B	UWM90
#4	VT-4B	UWM90
#2 Sol	VT-2SB	UWM115
#2	VT-2B	UWM115
2/0	VT-2/0K	UWM200
4/0	VT-4/0K	UWM250
250 MCM	VT-25CMB	UWM250

CABLE TO LUG OR BUS BAR ULTRAWELD CONNECTION

LE (LUG END) CONNECTION TYPE

Cable Size	Lug Size	Mold Part No.	Weld Metal
#6	1/8 x 1	LE-6181B	UWM45
#4	1/8 x 1	LE-4181B	UWM45
#2	1/8 x 1	LE-2181B	UWM45
2/0	1/8 x 1	LE-2/0181B	UWM65
	1/4 x 1	LE-2/0141B	UWM65
4/0	3/16 x 1	LE-4/03161B	UWM90
	1/4 x 1	LE-4/0141B	UWM90
250 MCM	1/4 x 1-1/2	LE-4/0141.5B	UWM90
	1/4 x 1	LE-25CM141B	UWM90
300 MCM	1/4 x 1-1/2	LE-25CM141.5B	UWM90
	1/4 x 1	LE-3CM141B	UWM90
400 MCM	1/4 x 1-1/2	LE-3CM141.5B	UWM90
	1/4 x 1	LE-400CM141B	UWM90
500 MCM	1/4 x 1-1/2	LE-400CM141.5B	UWM90
	1/4 x 1	LE-500CM141B	UWM90
750 MCM	1/4 x 1-1/2	LE-500CM141.5B	UWM90
	1/4 x 1	LE-750CM141B	UWM90
1000 MCM	1/4 x 1-1/2	LE-750CM141.5B	UWM90
	1/4 x 1	LE-1000CM141B	UWM90

LE (LUG END) CONNECTION TYPE

Cable Size	Lug Size	Mold Part No.	Weld Metal
500 MCM	1/4 x 1-1/2	LE-5CM141.5B	UWM200
	1/4 x 2	LE-5CM142B	UWM200
750 MCM	3/8 x 1-1/2	LE-5CM381.5B	UWM200
	3/8 x 2	LE-5CM382C	2-UWM150
1000 MCM	1/4 x 2	LE-75CM142C	2-UWM150
	3/8 x 1-1/2	LE-75CM381.5C	2-UWM150
1500 MCM	3/8 x 2	LE-75CM382C	2-UWM150
	1/2 x 2	LE-1MM382C	2-UWM200
2000 MCM	1/2 x 2	LE-1MM122C	UWM500

For Lugs, see following page.

**Looking for a product not listed in
the catalog? No problem!**

**Just call Primus at (800) 435-1636
with your specific need and we will
be glad to help!**

COPPER LUGS

For use with LE Style Molds

COPPER LUGS—STRAIGHT AND OFFSET

Lug Size	Straight Part No.	Offset Part No.	# of Holes	Hole Size	O.C. Dimension	T	W	A	B
1/8 x 1	SXL-181	OXL-181	1	3/8	—	1/8	1	1/2	7/8
	SXL-1812C3/8	OXL-1812C3/8	2	3/8	1	1/8	1	5/8	3
	SXL-1812B	OXL-1812B	2	1/2	.75	1/8	1	5/8	3
	SXL-1812C	OXL-1812C	2	1/2	1	1/8	1	5/8	3
	SXL-1812D	OXL-1812D	2	1/2	1.75	1/8	1	5/8	3
3/16 x 1	SXL-3161	OXL-3161	1	3/8	—	3/16	1	9/16	1-1/8
	SXL-31612C3/8	OXL-31612C3/8	2	3/8	1	3/16	1	5/8	3
	SXL-31612B	OXL-31612B	2	1/2	.75	3/16	1	5/8	3
	SXL-31612C	OXL-31612C	2	1/2	1	3/16	1	5/8	3
	SXL-31612D	OXL-31612D	2	1/2	1.75	3/16	1	5/8	3
1/4 x 1	SXL-141	OXL-141	1	1/2	—	1/4	1	5/8	1-1/8
	SXL-1412B	OXL-1412B	2	1/2	.75	1/4	1	5/8	3
	SXL-1412C	OXL-1412C	2	1/2	1	1/4	1	5/8	3
	SXL-1412D	OXL-1412D	2	1/2	1.75	1/4	1	5/8	3
1/4 x 1-1/2	SXL-141.5	OXL-141.5	1	5/8	—	1/4	1-1/2	3/4	1-1/2
	SXL-141.52B	OXL-141.52B	2	1/2	.75	1/4	1-1/2	5/8	3
	SXL-141.52C	OXL-141.52C	2	1/2	1	1/4	1-1/2	5/8	3
	SXL-141.52D	OXL-141.52D	2	1/2	1.75	1/4	1-1/2	5/8	3
1/4 x 2	SXL-1422B	OXL-1422B	2	1/2	.75	1/4	2	5/8	3
	SXL-1422C	OXL-1422C	2	1/2	1	1/4	2	5/8	3
	SXL-1422D	OXL-1422D	2	1/2	1.75	1/4	2	5/8	3
3/8 x 1-1/2	SXL-381.5	OXL-381.5	1	5/8	—	3/8	1-1/2	3/4	1-1/2
	SXL-381.52B	OXL-381.52B	2	1/2	.75	3/8	1-1/2	5/8	3
	SXL-381.52C	OXL-381.52C	2	1/2	1	3/8	1-1/2	5/8	3
	SXL-381.52D	OXL-381.52D	2	1/2	1.75	3/8	1-1/2	5/8	3
3/8 x 2	SXL-382	OXL-382	1	5/8	—	3/8	2	1	2-1/8
	SXL-3822B	OXL-3822B	2	1/2	.75	3/8	2	5/8	3
	SXL-3822C	OXL-3822C	2	1/2	1	3/8	2	5/8	3
	SXL-3822D	OXL-3822D	2	1/2	1.75	3/8	2	5/8	3

COPPER LUGS

For use with LE Style Molds

COPPER LUGS—BENT

Lug Size	Bent Part No.	# of Holes	Hole Size	O.C. Dimension	T	W	A	B
1/8 x 1	BXL-181	1	3/8	—	1/8	1	7/16	7/8
	BXL-1812B	2	1/2	.75	1/8	1	5/8	3
	BXL-1812C	2	1/2	1	1/8	1	5/8	3
	BXL-1812D	2	1/2	1.75	1/8	1	5/8	3
3/16 x 1	BXL-3161	1	1/2	—	3/16	1	5/8	1-1/4
	BXL-31612B	2	1/2	.75	3/16	1	5/8	3
	BXL-31612C	2	1/2	1	3/16	1	5/8	3
	BXL-31612D	2	1/2	1.75	3/16	1	5/8	3
1/4 x 1	BXL-141	1	1/2	—	1/4	1	5/8	1-1/4
	BXL-1412B	2	1/2	.75	1/4	1	5/8	3
	BXL-1412C	2	1/2	1	1/4	1	5/8	3
	BXL-1412D	2	1/2	1.75	1/4	1	5/8	3
1/4 x 1-1/2	BXL-141.5	1	5/8	—	1/4	1-1/2	3/4	1-1/2
	BXL-141.52B	2	1/2	.75	1/4	1-1/2	5/8	3
	BXL-141.52C	2	1/2	1	1/4	1-1/2	5/8	3
	BXL-141.52D	2	1/2	1.75	1/4	1-1/2	5/8	3
3/8 x 1-1/2	BXL-381.5	1	5/8	—	3/8	1-1/2	3/4	1-1/2
	BXL-381.52B	2	1/2	.75	3/8	1-1/2	5/8	3
	BXL-381.52C	2	1/2	1	3/8	1-1/2	5/8	3
	BXL-381.52D	2	1/2	1.75	3/8	1-1/2	5/8	3
3/8 x 2	BXL-382	1	5/8	—	3/8	2	3/4	1-1/2
	BXL-3822B	2	1/2	.75	3/8	2	5/8	3
	BXL-3822C	2	1/2	1	3/8	2	5/8	3
	BXL-3822D	2	1/2	1.75	3/8	2	5/8	3

Primus Electronics is a Full Line Harger Distributor. If you can't find a product you are looking for, please call us at (800) 435-1636 or email sales@primuselectronics.com

Visit us online at www.primuselectronics.com

GROUNDING AND BONDING

Copper Clad Steel Ground Rods—Application Notes:

AREMA 11.3.4 (Summarized) - Signal Systems

- Copper clad steel rods shall conform to UL467 and shall have a minimum nominal diameter of 5/8"

AREMA 19.1.14 (Summarized) - Communications Facilities

- Ground rods shall be a minimum of 1/2" in diameter and 5' long

NEC 2002 Article 250.53 (G) (Summarized)

- The electrode shall be installed so that 8' of length is in contact with the soil. It shall be driven to a depth of not less than 8' except where rock bottom is encountered. In the case of bedrock, the electrode shall be driven at an angle not to exceed 45 degrees from the vertical or shall be buried in a trench that is at least 2-1/2" deep

UL 467 9.2.1 (Summarized)

- A solid rod electrode of copper or other suitable non-ferrous metal, or a solid rod electrode of iron or steel with a copper or other suitable non-ferrous metal or stainless steel jacket, shall have a diameter not less than 1/2" thick

UL 467 9.2.3 (Summarized)

- The copper jacket mentioned in 9.2.1 shall not be less than .010" thick at any point

COPPER CLAD STEEL GROUND RODS

Product No.	Size	Approx. Wt. each (lbs)	Standard Bundle	Approx. Wt. bundle (lbs)	AREMA 11.3.4	AREMA 19.1.14
1210	1/2" x 10'	7	10	70	No	Yes
588	5/8" x 8'	7	10	70	Yes	Yes
5810	5/8" x 10'	9	10	90	Yes	Yes
348	3/4" x 8'	11	3	33	Yes	Yes
3410	3/4" x 10'	13	3	39	Yes	Yes
110	1" x 10'	23	3	66	Yes	Yes

GALVANIZED STEEL GROUND RODS

Product No.	Size	Approx. Wt. each (lbs)	Standard Bundle	Approx. Wt. bundle (lbs)
588G	5/8" x 8'	8	5	40
5810G	5/8" x 10'	10	5	50
348G	3/4" x 8'	12	5	36
3410G	3/4" x 10'	15	3	15

Galvanized Steel Ground Rods—Application Notes:

- Manufactured from zinc coated high strength steel
- Meets requirements of NEMA GR-1
- Preferred electrode when primary concern is cathodic protection to structure
- Non-UL listed

- Galvanized ground rods listed meet the requirements of AREMA 19.1.14 for communication facilities

GROUNDING AND BONDING

Stainless Steel Ground Rods—Application Notes:

UL 467 9.2.1 (Summarized)

- A solid rod electrode of copper or other suitable non-ferrous metal, or a solid rod electrode of iron or steel with a copper or other suitable non-ferrous metal or stainless steel jacket, shall have a diameter not less than 1/2" thick

UL 467 9.2.2 (Summarized)

- The copper jacket mentioned in 9.2.1 shall not be less than .015" thick at any point

UL 467 9.2.6 (Summarized)

- The stainless steel jacket mentioned above on a stainless steel rod, shall be formed of an austenitic stainless steel of the 18% chromium, 8% nickel type
- Stainless steel ground rods are used in corrosive soil conditions

STAINLESS STEEL GROUND RODS

Product No.	Size	Approx. Wt. each (lbs)	Standard Bundle	Approx. Wt. bundle (lbs)
1210SS3	1/2" x 10'	7	5	35
588SS3	5/8" x 8'	9	5	45
5810SS3	5/8" x 10'	11	5	55
3410SS3	3/4" x 10'	15	5	75

- Stainless steel ground rods listed meet the requirements of AREMA 19.1.14 for communication facilities

Sectional Stainless Steel Ground Rods—Application Notes:

- Sectional ground rods are used to help reduce ground resistance in poor soils such as sand and gravel
- Doubling ground rod length theoretically reduces resistance 40%

SECTIONAL STAINLESS STEEL GROUND RODS

Product No.	Size	Approx. Wt. each (lbs)	Standard Bundle	Approx. Wt. bundle (lbs)
S585SS3	5/8" x 5'	6	5	30
S588SS3	5/8" x 8'	9	5	45
S5810SS3	5/8" x 10'	11	5	55
S3410SS3	3/4" x 10'	15	5	75

- Sectional stainless steel ground rods listed meet the requirements of AREMA 19.1.14 for communication facilities
- SS-3 = Type 304 Stainless Steel—Non-ferrous, UL listed
- Other sizes are available, contact Primus for details

COMMUNICATIONS SITE EQUIPMENT

Halo Standoff Clamps

- Used for mounting interior halo ground rings
- Supplied with two anchors for mounting to both masonry and stud walls

HALO STANDOFF CLAMPS

Product No.	Clip Style	Conductor Range	Notes	Box Qty.	Approx. Wt. box (lbs)
HSC100	Stainless steel w/insulating rubber grommet	#6 AWG insulated to 1/0 AWG bare	Will hold halo 1" off the wall	1	1/4
HSC100C	Bare copper	#6 AWG insulated to 2/0 AWG bare	Will hold halo 1" off the wall	1	1/4
HSC150	Stainless steel w/insulating rubber grommet	#6 AWG insulated to 1/0 AWG bare	Will hold halo 1-1/2" off the wall	1	1/4
HSC150C	Bare copper	#6 AWG insulated to 2/0 AWG bare	Will hold halo 1-1/2" off the wall	1	1/4

STAINLESS STEEL CLIP

Product No.	Description	Conductor Range	Box Qty.	Approx. Wt. box (lbs)
CC5	5/16" 304 SS clip with insulating rubber grommet	#6 AWG insulated to 1/0 AWG bare	100	1-1/2

Tower Air Terminals

- 5/8" diameter x 5' long air terminal made from copper clad steel (10 mil)
- Air terminal features 2" of 5/8" - 11 UNC coarse threads and comes complete with mounting hardware
- Other sizes are available, please contact Primus for details

TOWER AIR TERMINALS

Product No.	Qty.	Notes	Approx. Wt. Ea. (lbs)
585CCat	EA	Copper clad steel provides superior strength and is less susceptible to wind shear than solid copper air terminals	4-1/4
585CCAT-2/0	EA	25' of 2/0 AWG 19 strand copper conductor exothermically welded to air terminal; tail can be exothermically welded to steel tower, ground bar or connected to a down conductor	14-1/2

COMMUNICATIONS SITE EQUIPMENT

Pipe Mount Air Terminal Kits Include:

- (1) 1224CUAT (1/2" x 24") copper air terminal
- (1) Universal pipe clamp with air terminal adapter
- (1) N518S 5/16–18 stainless steel hex nut
- (1) LW5S 5/16 stainless steel lock washer
- (1) W5S 5/16 stainless steel flat washer
- (1) 5' factory exothermically welded pigtail conductor

Note: Other styles are available, please contact Primus for details

PIPE MOUNT AIR TERMINAL KITS				
Product No.	Pipe Range	Conductor Type	Qty.	Approx. Wt. Ea (lbs)
PMATKT2.5/32T	2.5" - 3"	5' x #2 AWG solid tinned	EA	6-3/4
PMATKT3.5/42/0T	3.5" - 4"	5' x 2/0 AWG 19 strand tinned	EA	7-3/4

Guy Wire Clamps

- Can be used for connecting 2 dissimilar conductors such as copper and galvanized steel
- One bolt stainless steel clamp comes with stainless steel hardware
- Accommodates up to 7/8" guy wire and 4/0 AWG conductor

GUY WIRE CLAMPS		
Product No.	Box Qty.	Approx. Wt. Box (lbs)
SSC25/875	10	3-1/4

Weather Proofing Kits

- Used to weatherproof electrical connector junctions and grounds
- Includes 2" x 20' premium all weather vinyl electrical tape
- Includes 2-1/2" x 2' Butyl Mastic

WEATHER PROOFING KITS				
Product No.	Rolls of Mastic	Rolls of Tape	Qty.	Approx. Wt. Ea (lbs)
WP1KIT	1	1	EA	1/2
WP3KIT	3	2	EA	1-1/2
WP5KIT	5	3	EA	2-1/2

Primus Electronics is a Full Line Harger Distributor.

If you can't find a product you are looking for, please call us at (800) 435-1636 or email sales@primuselectronics.com

Visit us online at www.primuselectronics.com

COMMUNICATIONS SITE EQUIPMENT

Coax Ground Kits

- 2-bolt coax ground kit featuring captive hardware design allows greater ease of installation while providing a functional, high quality ground
- Designed to eliminate over tightening and damaging the coax shield
- Complies with MIL-STD-188-124B
- Other sizes and configurations are available, please contact Primus for details

Kit Includes:

- (1) Preformed copper ground strap complete with “captive” hardware
- (1) 5’ of #6-7 strand AWG THW ground conductor
- (1) “Universal” style ground lug which accommodates 3/4” to 1” spaced holes
- (2) Sets of stainless steel hardware to attach ground lug to ground bar
- (1) Butyl Mastic (2-1/2” x 24”)
- (1) Black electrical tape (2” x 20’)

COAX GROUND KITS

Product No.	Coax Style	Approx. Wt. Ea (lbs)
CGKBB3/8-5	3/8 Corrugated	1-1/2
CGKBB1/2-5	1/2 Corrugated	1-1/2
CGKBB5/8-5	5/8 Corrugated	1-1/2
CGKBB7/8-5	7/8 Corrugated	1-1/2
CGKBB1-1/4-5	1-1/4 Corrugated	1-1/2
CGKBB1-5/8-5	1-5/8 Corrugated	1-1/2
CGKBB2-1/4-5	2-1/4 Corrugated	1-1/2

Universal Ground Kit

- Accommodates Transmission line sizes 1/2” through 2-1/4”
- 5’ of #6 AWG ground lead provided with special factory attached ground lugs
- “Universal” style ground lug accommodates 3/4” to 1” spaced holes on ground bar
- Stainless steel hardware and waterproofing materials included
- Complies with MIL-STD-188-124B

UNIVERSAL GROUND KIT

Product No.	Qty.	Approx. Wt. Ea (lbs)
UGK-5	EA	1-3/4

For product information, pricing and availability please contact a Primus Sales Representative at (800) 435-1635 or sales@primuselectronics.com

COMMUNICATIONS SITE EQUIPMENT

Tower Standoff for Round Members TSO Series

- The fast, easy and economical way to make quality attachments of ground bars and other components to round tower members
- Manufactured from 300 series stainless steel for optimum compatibility
- 3/8—16 x 5/8" stainless steel hex head cap screw and lock washer included
- Available with or without stainless steel hose clamps in a variety of sizes

TOWER STANDOFF WITH HOSE CLAMP

Product No.	Round Member Size OD	Box Qty.	Approx. Wt. Box (lbs)
TSOC.75/1.75	.75" - 1.75"	10	2-1/2
TSOC2/2.75	2" - 2.75"	10	3-1/2
TSOC3/3.75	3" - 3.75"	10	3-1/2
TSOC4/4.75	4" - 4.75"	10	4
TSOC5/5.75	5" - 5.75"	10	4
TSOC6/6.75	6" - 6.75"	10	4

Tower Standoff for Snap-Ins TSOSI Series

- The fast, easy and economical way to provide snap-in mounting of coaxial cables to round tower members
- Manufactured from 300 series stainless steel for optimum compatibility
- 3/4" hole for snap-in
- Available with or without stainless steel hose clamps in a variety of sizes
- Snap-in not included

TOWER STANDOFF FOR SNAP-INS WITH HOSE CLAMP

Product No.	Round Member Size OD	Box Qty.	Approx. Wt. Box (lbs)
TSOCSI1.25/1.75	1.25" - 1.75"	10	3-1/4
TSOCSI2/2.75	2" - 2.75"	10	3-1/2
TSOCSI3//3.75	3" - 3.75"	10	3-1/2
TSOCSI4/4.75	4" - 4.75"	10	3-3/4
TSOCSI5/5.75	5" - 5.75"	10	3-3/4
TSOCSI6/6.75	6" - 6.75"	10	4

Stainless Steel Coax Hangers

- For mounting coax cable tower
- Innovative snap-on design replaces butterfly style coax hanger
- Available with or without hardware kit—kit consists of 3/8" x 3/4" fillister bolts, star washers and nuts
- Provides approximately double the holding strength of a clip style hanger
- Patent Pending
- Double Coax Hangers also available

SINGLE SS COAX HANGERS

Product No.	Description	Box Qty.	Approx. Wt. Box (lbs)
SSCH7/8	7/8" Snap-on Coax Hanger	25	1-1/4
SSCH7/8KIT	7/8" with mounting hardware kit	25	3-3/4
SSCH15/8	1-5/8" Snap-on Coax Hanger	25	2
SSCH15/8KIT	1-5/8" with mounting hardware kit	25	6

COMMUNICATIONS SITE EQUIPMENT

Double Stainless Steel Coax Hangers

- For mounting a coax cable to an existing coax cable
- Innovative pre-assembled double snap-on coax hangers manufactured from high tensile stainless steel
- Requires no hardware
- Single Coax Hangers also available

DOUBLE SS COAX HANGERS

Product No.	Description	Box Qty.	Approx. Wt. Box (lbs)
SSDCH7/8	7/8" Double Snap-on Coax Hanger	25	4
SSDCH15/8	1-5/8" Double Snap-on Coax Hanger	25	6-1/2

Stainless Steel Down Conductor Standoff

- Fast, easy and economical way to attach down conductors to round tower members
- Range taking down conductor cable clamp with tower standoff
- The small side of the clamp accommodates bare stranded conductors from #6 up to 2/0 AWG while the large side accommodates from 2/0 to 4/0 AWG
- The small side of the clamp accommodates insulated conductors from #8 up to 2/0 AWG while the large side accommodates from #1 up to 4/0 AWG
- Manufactured from stainless steel to allow use with any type of wire
- Available with stainless steel hose clamps in a variety of sizes, please contact Primus for more details

SS DOWN CONDUCTOR STANDOFF

Product No.	Box Qty.	Approx. Wt. Box (lbs)
SSDCSO	5	3-1/2

Stainless Steel Down Conductor Angle Adapter

- Fast, easy and economical way to attach down conductors to flat tower members
- Designed to attach to flat steel tower members
- Range taking down conductor cable clamp with tower standoff
- The small side of the clamp accommodates bare stranded conductors from #6 up to 2/0 AWG while the large side accommodates from 2/0 to 4/0 AWG
- The small side of the clamp accommodates insulated conductors from #8 up to 2/0 AWG while the large side accommodates from #1 up to 4/0 AWG
- Manufactured from stainless steel to allow use with any type of wire

SS DOWN CONDUCTOR ANGLE ADAPTER

Product No.	Box Qty.	Approx. Wt. Box (lbs)
SSDCAA	5	4

VEHICLE LAPTOP MOUNTING SYSTEMS

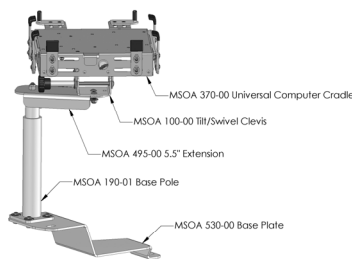

Fits:
Jeep Liberty (2002-Newer)

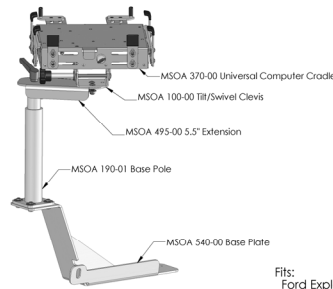

Fits:
Ford Explorer (2002-Newer)

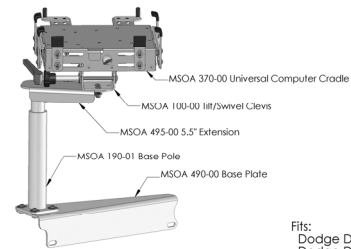

Fits:
Dodge Dakota (1997-Newer)
Dodge Durango (1997-2003)

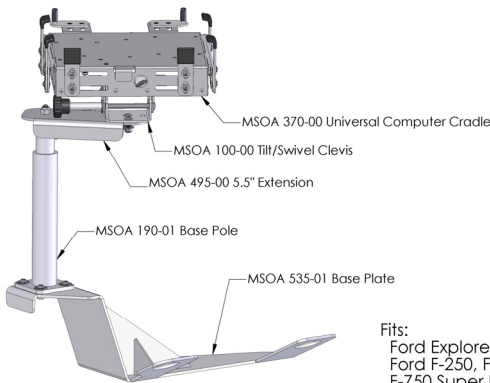

Fits:
Ford Explorer (2002-2005)
Ford F-250, F-350, F-450, F-550
F-750 Super Duty (1999-Newer)

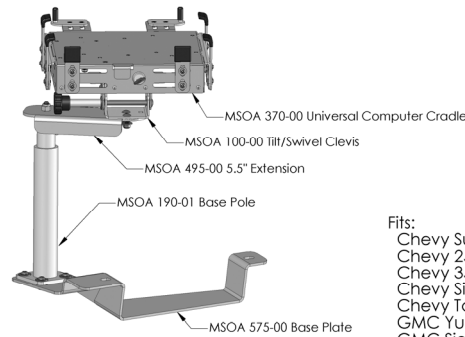

Fits:
Chevy Suburban (2000-Newer)
Chevy 2500 C/K (2000-Newer)
Chevy 3500 C/K (2000-Newer)
Chevy Silverado (1999-Newer)
Chevy Tahoe (2000-Newer)
GMC Yukon (2000-Newer)
GMC Sierra (2000-Newer)

VEHICLE LAPTOP MOUNTING SYSTEMS

All Computer Mounting Systems of America include a vehicle specific base, lower post, upper post with handle and collar, tilt and swivel bracket, a universal computer cradle and screen holder.

Mounting systems for all model vehicles. Call for quote.

Product No.	Description	Price
PRIMUS556	1997-2004 Dodge Dakota A/T Vehicle Laptop Mounting System	CALL
PRIMUS551	2003-2006 Jeep Liberty Vehicle Laptop Mounting System	CALL
PRIMUS552	1996-1998 Jeep Cherokee Vehicle Laptop Mounting System	CALL
PRIMUS553	2000-2006 Chevy Suburban Vehicle Laptop Mounting System	CALL
PRIMUS554	2004-2006 Ford Excursion Vehicle Laptop Mounting System	CALL
PRIMUS555	2002-2006 Ford Explorer Vehicle Laptop Mounting System	CALL
PRIMUS500	Replacement for Motorola VLM 4777 Clam Shell Mobile Radio Mount modified for the Spectra mobile and speaker or the Kenwood TK series mobiles and speaker	\$70.00

WIRELESS EQUIPMENT

Flanger™ T1 and E1 Transport Over Ethernet For Wireless Networks —

Flanger™ enables point-to-point multiplexing of T1 and E1 traffic across wired and wireless Ethernet devices. This small, simple-to-use unit provides seamless transport of T1 and E1 across an Ethernet link; allowing for dramatic cost savings compared to the cost of conventional leased lines.



Flanger can support one to four T1's or E1's per link. Flanger also allows multiplexing of LAN traffic along with the T1/E1

payload. The LAN traffic utilizes the available bandwidth in the connection to deliver even more value.

FLANGER APPLICATIONS

- Eliminate monthly leased line charges
- Ideal for PBX's in campus environments
- Cellular backhaul
- Disaster recovery and redundant T1/E1 links
- Protect legacy equipment investments
- Broadband for special events
- POTS line extension

FLANGER VALUE PROPOSITION

- Fast and easy to deliver T1 service
- Eliminate re-occurring monthly T1 charges
- Quick ROI

FLANGER LAN PORT

Product #	Description	Price
FL4001A	1 Port Unit (E1 or T1)	\$995
FL4002A	2 Port Unit (E1 or T1)	\$1,165
FL4003A	3 Port Unit (E1 or T1)	\$1,335
FL4004A	4 Port Unit (E1 or T1)	\$1,495

Strongbow™ Video Transport System —

The MemoryLink Strongbow Video Transport System provides a high quality, low latency, affordable solution for video compression and transport across wired and wireless Ethernet devices.

Strongbow's near DVD quality video and CD quality audio, coupled with a latency of only 100ms, delivers unparalleled video quality for the price point.

Memorylink Strongbow transport is IP-based, so it can be routed through your network.

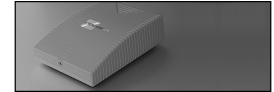

STRONGBOW FEATURES

- Very high quality video & audio with low delay
- 1-30 frames per second, up to 8.5 Mbps
- Power over CAT5 (input and output)
- Video transport over Ethernet radios
- Accepts composite video or S-video, stereo audio
- PC software for streaming, viewing, storing, & playback

STRONGBOW VALUE PROPOSITION

- Very high quality, low latency video & audio
- Alternative to expensive or impossible cabling
- Eliminate costly leased lines for video & audio delivery
- Cost effective wireless transport system
- Quick ROI

STRONGBOW

Product #	Description	Price
STP2000A	Pair of IP Level Strongbows	\$2,190

For additional wireless equipment products, please request our Broadband Products Catalog by calling (800) 435-1636

LOCOMOTIVE RADIO TESTER

“BackTalk” Automatic Locomotive Radio Tester Exclusive to Primus Electronics

Previously, Locomotive Radios were mounted and tested by Telecom personnel. Asking for a radio check from another unit around the yard was time consuming and prone to highly inaccurate results due to power and the distance of the responding unit.



The *BackTalk* solves this problem by providing a simple and accurate test of the Locomotive Radio. The *BackTalk* can be used by Mechanical, Telecom and any other personnel who are provided with the access code.

The Locomotive Radio is mounted and the power/antenna cables are attached. A specific DTMF code is entered from the pad on the Locomotive Radio and the radio tester speaks into a microphone. When the push to talk switch is released, the *BackTalk* will repeat back the testers voice allowing a determination of the health of the radio based on the quality of the rebroadcast signal.

The *BackTalk* accomplishes this by challenging the Locomotive Radio via adjustable attenuation of both the received and the transmitted signal. Only a “good” Locomotive Radio can complete the test successfully. The *BackTalk* confirms acceptable operation of the complete system, including the radio, DTMF pad, microphone, and locomotive antenna system.

The *BackTalk* allows automatic, unattended yard or remote right-of-way testing of Locomotive Radios.

Features include:

- Adjustable power from 1/2—25 watts, user specified
- Operates on VHF standard or narrow band frequency, user specified
- Up to 30 second digital record/repeat time (default set at 10 seconds)
- Complete antenna, surge projection and feed line available from Primus to complete the system install
- DC operation standard, AC optional
- DTMF access code, user specified
- Mount can be racked or used as a desktop unit

BACKTALK MODELS

Product #	Description	Price
PRIMUS150/DC	Primus <i>BackTalk</i> —Basic unit set up for DC power, no attenuator. Includes accessory kit.	\$1,021.73
PRIMUS150/DC-70	Primus <i>BackTalk</i> —Basic unit including 70dB adjustable attenuator. Includes accessory kit.	\$1,221.73
PRIMUS150/AC	Primus <i>BackTalk</i> —Basic unit set up to operate from AC 110V power, no attenuator. Includes accessory kit.	\$1,090.06
PRIMUS150/AC-70	Primus <i>BackTalk</i> —Basic unit set up to operate from AC 110V power including attenuator. Includes accessory kit.	\$1,290.06

SUGGESTED ANTENNA OPTIONS

Product #	Description	Price
SD210SF2P2SNM	138-174 MHz Exposed Dipole—fixed pattern antenna, 1/2”, N-Male conn	\$223.50
BS150U-161	Unity gain heavy duty fiberglass omni includes mounting clamps.	\$98.00

Visit us online at www.primuselectronics.com

BATTERY MAINTENANCE / ANALYZER / CONDITIONER

NiCAD End-of-Train Battery Maintenance/Charger

You need to know your batteries will work when the train leaves the terminal. You realize their performance can impact the on-time schedule to its destination. The iQ^{plus} gives you that confidence. The iQ^{plus} has become the cost effective end-of-train standard for those occasions when you need an easy-to-use, accurate and effective Battery Analysis/Conditioning product for NiCAD batteries.

- Analyze mode measures capacity and reports the results on an LCD.
- Condition mode restores capacity by recycling the battery through successive charge/discharge cycles.
- Discharge mode tests the capacity your charger delivers to your battery.
- For NiCAD and NiMH batteries (Not compatible with Li-Ion).



BC3603QC-EOT

IQ^{PLUS} END OF TRAIN BATTERY MAINTENANCE

Product #	Description	Price
BC3603QC-EOT	Three Station Analysis/Conditioner for End-of-Train. Does NOT require an adapter.	\$760.00



BC3501QC



BC3503QC

IQ^{PLUS} ANALYZER / CONDITIONER

Product #	Description	Price
BC3501QC	One Station - 115 VAC (NiCAD/NiMH @ 600mA)	\$365.00
BC3503QC	Three Station - 115 VAC (NiCAD/NiMH @ 600mA)	\$408.00
BC3603QC	Three Station - 115 VAC (NiCAD/NiMH @ 900mA)	\$469.00

iQpac Personal Analyzer Charger

The iQpac personal analyzer is for those who use a personal radio and rely on their batteries.

Features a tri-mode operation:

- Charge, Quick Analyze, to Analyze
- Condition while charging
- Spec analyze to test battery to specification standards for warranty returns

For all popular radio batteries; NiCAD, NiMH, Li-Ion. Selectable conditioning pulse or constant charge with three selectable rates. Personalized for your battery. 115 and 230/240VAC models. Breakthrough pricing makes iQpac accessible to everyone. Order adapter separately.

IQ^{PAC} PERSONAL ANALYZER CHARGER

BCIQPAC	One Station - 115 VAC (NiCAD/NiMH @ 500, 1000 or 1500mA). Order adapter separately.	\$160.00
---------	-------------------------------------------------------------------------------------	----------

Toll-Free (800) 435-1636 • Fax (800) 767-7605

BATTERY MAINTENANCE / ANALYZER / CONDITIONER

iQ^{five} Analyzer / Conditioner

The iQ^{five} is the most reliable and economic battery test and maintenance product in its class. Never go into the field without complete confidence in your battery's performance. The iQ^{five} allows you to focus on your job without worrying about your radio's capabilities.

- Analyze mode measures capacity and reports the results on a LCD
- Condition mode restores capacity by recycling the battery through 3 successive charge / discharge cycles
- Cycle Test mode "forms" new batteries to ensure best out-of-box performance
- Discharge mode tests the capacity your charge delivers to your battery

Battery adapters available for more than 600 wireless products. For all Radio batteries; NiCAD, NiMH, Li-Ion. Print test results for all battery stations on Star SP200 or compatible dot matrix printer.

IQ^{PLUS} END OF TRAIN BATTERY MAINTENANCE

Product #	Description	Price
BC3506QP-5	Six Station - 115 VAC (NiCAD/NiMH @ 600mA; Li-ion @ 900mA)	\$635.00



BC3506QP-5



BC3503PC

Charger^{plus} Analyzer / Conditioner

The Charger^{plus} is for people who need a battery charger with the capability to analyze and condition their batteries in a cost-effective package.

- Three or six powerful charge stations with one analyze / condition station
- Analyze mode measures the capacity and reports results on a LCD
- Condition mode restores capacity by recycling the battery through successive charge / discharge cycles
- Discharge mode tests the capacity your charger delivers to your battery (on analyzer station)
- Discharge mode option available before charge (on charger station)

For NiCAD and NiMH batteries; not compatible with Li-Ion.

CHARGER^{PLUS} ANALYZER / CONDITIONER

Product #	Description	Price
BC3503PC	Three Station (2+1) - 115 VAC (NiCAD/NiMH @ 600mA)	\$415.00
BC3506PC	Six Station (5+1) - 115 VAC (NiCAD/NiMH @ 600mA)	\$491.00

Visit us online at www.primuselectronics.com

ADAPTORS

KENWOOD ADAPTORS

Radio	Personal Chargers—BCIQPACxxxxxx	Price	Bank Chargers—BC35xxxxxx	Price
TK/250/350/353	PA1122	\$24.00	BA1122	\$31.25
TK260/270/360/370	PA1153	\$15.00	BA1153	\$31.25
TK260/270/360/370	PA1153	\$15.00	BA1153	\$31.25
TK290/390/480/481	PA4543	\$15.00	BA1179	\$31.25

MOTOROLA ADAPTORS

Product No.	Radio	Personal Chargers—BCIQPACxxxxxx	Price	Bank Chargers—BC35xxxxxx	Price
GP300	7.5v/1200 mAh	PA1055	\$15.00	BA1098	\$17.50
GP350	7.5v/1200 mAh			BA1142	\$31.25
HT50	7.5v/1200 mAh			BA1061	\$17.50
HT600/HT800	10.0V/1200 mAh	PA4545	\$15.00	BA1018	\$17.50
HT600/HT800	10.0V/1300 mAh	PA4545	\$15.00	BA1018	\$17.50
HT750/1250/1550	7.5V/1600 mAh	PA4014	\$15.00	BA4014	\$51.00
HT750/1250/1550	7.5V/2100 mAh	PA4014	\$15.00	BA4014	\$51.00
HT750/1250/1550	7.5V/2700/mAh	PA4014	\$15.00	BA4014	\$51.00
HT1000	7.5V/1200 mAh	PA4011	\$15.00	BA1105	\$24.00
JT1000		PA4011	\$15.00	BA4011	\$31.25
MT1000/MTX800	10.0V/1200 mAh	PA4545	\$15.00	BA1018	\$17.50
MT1000/MTX800	10.0V/1300 mAh	PA4545	\$15.00	BA1018	\$17.50
MT2000/HT1000	7.5v/1200mAh	PA4011	\$15.00	BA1105	\$24.00
MT2000/HT1000	7.5V/1500mAh	PA4011	\$15.00	BA1105	\$24.00
MT2000/HT1000	7.5V/2700 mAh	PA4011	\$15.00	BA1105	\$24.00
P10	11.25V/600 mAh	PA1022	\$24.00	BA1022	\$17.50
P10/50	7.5V/60 mAh	PA1022	\$24.00	BA1022	\$17.50
P110	7.5v/1200mAh			BA1098	\$17.50
P1225	7.5v/1200mAh	PA1155	\$15.00	BA1155	\$31.25
P200/P210	10.0V/1200 mAh	PA4545	\$15.00	BA1018	\$17.50
P200/P210	10.0V/1300 mAh	PA4545	\$15.00	BA1018	\$17.50

MISC. ADAPTORS

BP210—ICOM	7.2v/1650 mAh	PA1198	\$24.00	BA1198	\$24.00
FNBV-57—Yaesu/Vertex	7.2v/1450 mAh	PA1183	\$24.00	BA1183	\$17.50

Toll-Free (800) 435-1636 • Fax (800) 767-7605

BATTERIES**MOTOROLA BRANDED BATTERIES**

Product No.	Radio	Description	Price
NTN5414BR	HT600	1100 NiCad	\$55.72
NTN5447BR	MT1000	1100 NiCad	\$57.19
NTN7143CR	HT1000/MT2000	1200 NiCad	\$42.66
NTN7144CR	HT1000/MT2000	1500 NiCad	\$43.99
HNN8148B	P110	1100Mah NiCad	\$48.39
HNN9018AR	SP50	200 Mah NiCad	\$21.33
HNN9044AR	P10/SP50	550 Mah NiCad	\$17.33
HNN9049A	P1225	1200 Mah NiCad	\$39.99
HNN9008AR	HT750	1500 Mah NiCad	\$44.66
HNN9009AR	HT1250	1800 Mah NiCad	\$49.99
HNN9360B	GP350	1200 Mah NiCad	\$47.32
HNN9628B	GP300	1200 Mah NiCad	\$43.32
NNTN4496AR	CP150/200/PR400	1100 Mah Lion	\$43.32
NNTN4497BR	CP150/200/PR400	2250 Mah Lion	\$62.65
NNTN4970AR	CP150/200/PR400	1600 Mah Lion Slim	\$71.98
NNTN4851A	CP150/200/PR400	1400 Mah Nimh	\$43.32

Primus Electronics offers the complete line of Motorola Batteries.

If you don't see a product listed here, please contact us at (800) 435-1636.

Visit us online at www.primuselectronics.com

REPLACEMENT BATTERIES**MOTOROLA RADIO REPLACEMENT BATTERIES**

Product #	Radio	Volts / Cap	Price
AM-4496	CP200/PR400	7.5v/1100	\$26.60
AM-4497Li	CP200/PR400	7.5V/2100 mAh	\$40.85
AM-4851	CP200/PR400	1450 NI-MH	\$26.60
AM-5414	HT600	10V/1200 mAh	\$24.65
AM-5447	MT1000	10V/1200 mAh	\$24.65
AM-7143	HT1000	7.5V/1200 mAh	\$23.00
AM-7144	NTN7144	7.5V/1500 mAh	\$23.82
AM-7144N-27	HT1000	7.5V/2700 NI-MH	\$37.98
AM-8148	P110	7.5V/1200 mAh	\$24.65
AM-9008N	HT750/1250/1550	7.5V/1400 NI-MH	\$25.40
AMN-9008N	HT750/1250/1550	7.5V/1500 NI-MH	\$25.53
AM-9018	SP50	7.5V/1100 mAh	\$15.52
AM-9027	P10	11.25V/600 mAh	\$13.05
AM-9044	P10/50	7.5V/60 mAh	\$9.06
AM-9049-15	P1225	7.5V/1500 mAh	\$30.49
AM-9360	GP350	7.5V/1200 mAh	\$24.65
AM-9628	GP300	7.5V/1200 mAh	\$19.29

KENWOOD RADIO REPLACEMENT BATTERIES

Product #	Radio	Volts / Cap	Price
AK-KNB12	TK-250/350/353	7.2V/1200 mAh	\$22.17
AK-KNB12N	TK-250/350/353	7.2/1450 NIMH	\$22.17
AK-KNB15	TK-260/360/270/370	7.2V/1100 mAh	\$22.17
AK-KNB15-15	TK-260/360/270/370	7.2V/1500 mAh	\$25.75
AK-KNB17	TK-280/290/380/480	7.2V/1500 mAh	\$28.42

YAESU / VERTEX RADIO REPLACEMENT BATTERIES

Product #	Radio	Volts / Cap	Price
AY-FNB57	FNB-57	7.2V/1100 mAh	\$25.54
AY-FNB57N	FNBV57	7.2V/1450 mAh	\$25.54

Toll-Free (800) 435-1636 • Fax (800) 767-7605

REPLACEMENT BATTERIES

MOTOROLA REPLACEMENT BATTERIES

Product #	Radio	Volts / Cap	Price
M7143	MT2000/HT1000	7.5V/1200 mAh	\$30.00
M7144	MT2000/HT1000	7.5V/1500 mAh	\$31.00
M7144HX	MT2000/HT1000	7.5V/2700 mAh	\$40.00
M5447	MT1000/MTX800	10.0/1200 mAh	\$33.00
M5447B	MT1000/MTX800	10.0/1300 mAh	\$35.00
M5414	HT600/HT800	10.0/1200 mAh	\$33.00
M5414B	HT600/HT800	10.0/1300 mAh	\$35.00
M5521	P200/P210	10.0/1200 mAh	\$31.50
M5521B	P200/P210	10.0/1300 mAh	\$33.50
M8148	P110	7.5V/1200 mAh	\$32.00
M9628	GP300	7.5V/1200 mAh	\$30.00
M9360	GP350	7.5V/1200 mAh	\$34.00
M9049	P1225	7.5V/1200 mAh	\$35.00
M9009	HT750/1250/1550	7.5V/1600 mAh	\$43.00
M9009-H	HT750/1250/1550	7.5V/2100 mAh	\$55.00
M9009-HX	HT750/1250/1550	7.5V/2700 mAh	\$59.00

KENWOOD REPLACEMENT BATTERIES

Product #	Radio	Volts / Cap	Price
MKNB-14	TK260/270/360/370	7.5V/600 mAh	\$25.00
MKNB-15	TK260/270/360/370	7.5V/1100 mAh	\$24.00
MKNB-17	TK290/390/480/481	7.5V/1500 mAh	\$33.00

LOCOMOTIVE REMOTE CONTROL REPLACEMENT BATTERIES

Product #	Manufacturer	Volts / Cap	Price
AM-7144N-27	Axtech	7.5V/2700 mAh NI-MH	\$37.98
NA4013H	Multiplier	7.5V/2700 mAh NI-MH	\$30.00
M7144HX	Multiplier	7.5V/2700 mAh NI-MH	\$40.00

Visit us online at www.primuselectronics.com

PORTABLE REPLACEMENT ANTENNAS

PORTABLE REPLACEMENT ANTENNAS—KENWOOD TK SERIES

Kenwood Part #	Description	Centurion Replacement #	Price
KRA 14M	VHF Wideband	EXH-160-SFU, Use EXH-160-SFK	\$11.51
KRA 14M	VHF Wideband	EXH-160-SFK (Kenwood TK 290 Radio)	\$11.51

PORTABLE REPLACEMENT ANTENNAS—MX SERIES

Motorola Part #	Description	Centurion Replacement #	Price
8505816K03	VHF Molded	EXB-155-MX	\$8.00
8505816K21	VHF Molded	EXB-155-MX	\$8.00
NAD 6502	VHF Molded	EXB-155-MX	\$8.00
HAD 9742	Stubby VHF Molded	EXS-155-MX	\$8.50
XXXXXXX	Wideband Molded	EXH-160-MX	\$8.54

MX Series antennas are used on HT600, P200, GP350, GP300, HT750, HT1250, HT1550, P1225, SP50, HT50, MT1000. 155 Series antennas cover 155-164 MHz.

PORTABLE REPLACEMENT ANTENNAS—SF SERIES

Motorola Part #	Description	Centurion Replacement #	Price
8505644V02	VHF Helical	EXB-155-SF	\$10.00
XXXXXXX	VHF Wideband	EXH-160-SF	\$11.51

SF Series antennas are used on HT1000 and MT2000 radios. 155 Series antennas cover 155-164 MHz.

DRIBBLE ANTENNAS

Part #	Radio	Price
DR-150-MX	HT600, MT1000, GP Series, HT Series, P1225	\$15.00
DR-150-SF	HT1000, MT2000	\$17.00
DR-155-BN, Requires RFB1142	Kenwood TK Series	\$17.00
RFB1142-4	RF Industries Adaptor	\$2.49

For additional Centurion products, please contact Primus at (800) 435-1636

Toll-Free (800) 435-1636 • Fax (800) 767-7605

RADIO MANUFACTURER CROSS REFERENCE

Manufacturer	Radio Model	Connector Style	
Bendix King	EP, GP, LP	KR	
	LPX	SFU	
EF Johnson	Challenger, FM	BN style	
	LTR, Scorpion and newer models	SFJ	
Fujitsu	FTP	BN style	
MA COM/Ericsson/GE	EDACS 300P	SF	
	MPI, PCS	BN style	
	Monogram	MX	
	Jaguar, LPE, Panther 500P & 300P, MPD, MRK, EDACS, AEGIS	MD	
	Panther 600P & 400P	SM	
Kenwood	TK 100, 200, 210, 220, 300, 310, 320	BN style	
	TK 23-, 240, 250, 260, 270, 330, 340, 350, 360	MX	
	TK 290, 390, 480, 481 & 70G Series	SFU or SFK	
Maxon		BNC	
Vertex/Standard	VX-10/160/180/210/400/600/800/900	SMV	
	VX-10UA/600/800/900	SMV	
	VX-10UA/800AU	SMV	
	VX-10UF	SMV	
	VX-10VA/400/600/800/900	SMV	
	VX-160/210/400/600/900	SMV	
	VX-400	SMV	
	FTH Series	BN style	
	HX and VX 500 and VX50D Series	MX	
VX FTH and VX 200 Series	TN style		
Motorola	MT500 Omni, MT700, HT220	HT	
	HT10, HT50, HT600, MT1000, P10	MX	
	If antenna is 800 or 900 MHz, connector is SF.	P50, P100, P200, MX300, P1225, HT1250, HT1550, HT750, P10	MX
	Lower Frequencies use MX (except for older radios).	Radius, SP2000, SP2550, SP2850	MX
		Saber	MX
		MX360, STX, MTX, HT1000, MT2000	SF
		MTX8000, MTX9000, VISAR	SF
		LTS2000, MTS2000, MX340	SF
		SP5050HD, GP900, GP1200	SF
		SP5050, ASTRO, GP900, GP1200	SF
	XTS Series	SF	
Wilson		BN style	
TAIT		SM	
Midland		MX	
TOPAZ		MX	



MOTOROLA AFTERMARKET PRODUCTS

MOTOROLA BRANDED CHARGERS

Radio	Motorola Part #	Price
HT1000, JT1000, MT2000	RPX4747	\$88.31
HT1000, JT1000, MT2000	NTN1168	\$132.97
HT750, HT1250, HT1550	AAHTN3000	\$53.32
GP300, GP350, P1225, P110	HTN9042	\$54.65
HT600, P200	NTN5538	\$67.98
HT50, P100	NTN4864	\$117.64
MT1000	NTN4633	\$72.32
CP200	NNTN4075-R	\$69.95
PR400	WPLN4138	\$57.75

MOTOROLA SPEAKER MICROPHONES

Radio	Motorola Part #	Price
HT1000, JT1000, MT2000	NMN6193A	\$81.31
HT750, HT1250, HT1550	AAHMN9052A	\$61.65
GP300, P1225, P110, CP200, PR400	HMN9030A	\$68.65
GP350	HMN9031A	\$73.67
HT600, P200	NMN6156B	\$105.97
P100, HT50	NTN4849A	\$92.98

MOTOROLA AFTERMARKET PRODUCTS

Product No.	Description	Price
RR-178	Motorola DTMF Microphone for the Spectra Mobile unit. Modified Motorola microphone	\$195.00
TDN6581A	Motorola Locomotive Clean Cab Radio Mounting Plate	\$100.00
VMN1033	Motorola Locomotive Clean Cab Radio Microphone, Non-DTMF	\$89.00
RR-118	Locomotive Clean Cab Radio Microphone, DTMF, Not backlit with strain relief. Modified Motorola Microphone	\$200.00
RR-118A	Same as RR-118 but with right-angle connector	\$210.00

Toll-Free (800) 435-1636 • Fax (800) 767-7605

CONVERTERS, POWER SYSTEMS, BATTERY CHARGERS

DC-DC CONVERTERS / ISOLATED / ISOLATED SPIKE PROTECTED

Product #	Description	Price
12-12-12I	10-16 VDC Input; 12 VDC/12 Int - 8 Cont Amp Output	\$411.75
36-12-6ISP	18-65 VDC Input; 12 VDC/6 Int - 6 Cont Amp Output	\$404.25
36-12-18ISP	20-56 VDC Input; 12 VDC/18 Int - 10 Cont Amp Output	\$621.75
48-12-6I	20-56 VDC Input; 12 VDC/6 Int - 6 Cont Amp Output	\$298.50
48-12-12I	20-56 VDC Input; 12 VDC/12 Int - 8 Cont Amp Output	\$404.25
72-12-6ISP	42-90 VDC Input; 12 VDC/6 Int - 6 Cont Amp Output	\$404.25
72-12-18ISP	42-90 VDC Input; 12 VDC/18 Int - 10 Cont Amp Output	\$621.75

POWER SYSTEMS

IPS 12-40	13.6 VDC/40 Amp Output, Continuous (negative ground)	\$1,432.25
IPS 24-22	27.2 VDC/22 Amp Output, Continuous (negative ground)	\$1,432.25
IPS 48-11	54.4 VDC/11 Amp Output, Continuous (positive ground)	\$1,432.25

BATTERY CHARGERS

PT-7	13.6 VDC @ Float/7 Amp Max Output/14-70AH Batt Capacity	\$153.75
PT-24-8	27.2 VDC @ Float/8 Amp Max Output/16-80AH Batt Capacity	\$254.25
PT-24-40	27.2 VDC @ Float/40 Amp Max Output/80-400AH Batt Capacity	\$1,026.75
PT-70A	13.6 VDC @ Float/70 Amp Max Output/140-700AH Batt Capacity	\$1,031.25

Primus carries the full Newmar Line. Call Today!



RS SERIES

Product #	Cont. Duty	ICS	Single Unit	2-4 Units	5+ Units
RS-3A	2.5	3	\$30.00	\$28.85	\$28.00
RS-4A	3	4	\$37.50	\$36.10	\$35.25
RS-5A	4	5	\$42.50	\$40.90	\$40.00
RS-7A	5	7	\$50.00	\$48.25	\$47.00
RS-10A	7.5	10	\$62.45	\$60.20	\$58.80
RS-12A	9	12	\$72.50	\$69.85	\$68.20
RS-20A	16	20	\$89.00	\$85.50	\$83.50
RS-35A	25	35	\$144.00	\$138.55	\$135.25
RS-50A	37	50	\$207.50	\$200.00	\$195.25
RS-70A	57	70	\$247.45	\$238.55	\$233.00

LOW PROFILE POWER SUPPLIES

Product #	Cont. Duty	ICS	Single Unit	2-4 Units	5+ Units
SL-11A	7	11	\$66.20	\$63.80	\$62.30
SL-11R	7	11	\$66.20	\$63.80	\$62.30
SL-15R	12	15	\$87.50	\$84.30	\$82.30

28VDC CONVERTERS INPUT: 22-32 VDC, OUTPUT: 13.8 VDC

Product#	Cont. Duty	ICS	Single Unit	2-4 Units	5+ Units
N2412-12	10	12	\$48.65	\$46.90	\$45.80
N2412-24	20	24	\$72.40	\$69.80	\$68.15
2412-40	32	40	\$174.90	\$168.60	\$164.60

Visit us online at www.primuselectronics.com

POWER SUPPLIES

DESKTOP SWITCHING POWER SUPPLY (120 VAC-12VDC)

Product #	Description	Case Qty	Single	Case
ICT12012-4A	4 Amp Peak/3 Amp Continuous/Cigarette Recp	5	\$39.41	\$37.44
ICT12012-6A	6 Amp Peak/4.5 Amp Continuous/Cigarette Recp	5	\$51.25	\$49.69
ICT12012-10A	10 Amp Peak/8 Amp Continuous/7.1" Case Width	5	\$69.67	\$66.19
ICT12012-11A	11 Amp Peak/9 Amp Continuous/7.1" Case Width	5	\$74.93	\$71.19
ICT12012-12A	12 Amp Peak/10 Amp Continuous/7.1" Case Width	5	\$78.88	\$74.94
ICT12012-15A	15 Amp Peak/13 Amp Continuous/7.1" Case Width	4	\$92.04	\$87.44
ICT12012-20A	20 Amp Peak/17 Amp Continuous/7.1" Case Width	4	\$102.57	\$97.44
ICT12012-30A	30 Amp Peak/25 Amp Continuous/7.1" Case Width	4	\$144.38	\$136.78

DC-DC POWER CONVERTERS:

NON-ISOLATED INDUSTRIAL SERIES 24-12 POWER CONVERTERS

Product #	Description	Case Qty	Single	Case
ICT2412-2.5A	24VDC-12VDC Converter/2.5 Amp	5	\$55.49	\$52.57
ICT2412-5A	24VDC-12VDC Converter/5 Amp	5	\$59.65	\$56.51
ICT2412-10A	24VDC-12VDC Converter/10 Amp	5	\$62.43	\$59.14
ICT2412-15A	24VDC-12VDC Converter/15 Amp	5	\$80.49	\$76.25
ICT2412-20A	24VDC-12VDC Converter/20 Amp	5	\$109.65	\$103.88
ICT2412-30A	24VDC-12VDC Converter/30 Amp	5	\$156.88	\$148.62
ICT2412-40A	24VDC-12VDC Converter/40 Amp	5	\$194.38	\$184.14

DC-DC POWER CONVERTERS:

ISOLATED WALL MOUNT WIDE RANGE SERIES (12 VOLT)

Product #	Description	Price
ICT2060-12AIW	20-60VDC-12VDC Converter / 12 Amp	\$328.50
ICT2060-20AIW	20-60VDC-12VDC Converter / 20 Amp	\$428.50
ICT50100-12AIW	50-100VDC-12VDC Converter / 12 Amp	\$328.50
ICT50100-20AIW	50-100VDC-12VDC Converter / 20 Amp	\$428.50

Toll-Free (800) 435-1636 • Fax (800) 767-7605



POWER SUPPLIES

**DC-DC POWER CONVERTERS:
ISOLATED WALL MOUNT WIDE RANGE SERIES (24 VOLT)**

Product #	Description	Price
ICT206024-5AIW	20-60VDC—24VDC Converter / 5 Amp	\$342.79
ICT206024-10AIW	20-60VDC—24 VDC Converter / 10 Amp	\$442.79
ICT5010024-5AIW	50-100VDC—24 VDC Converter / 5 Amp	\$342.79
ICT5010024-10AIW	50-100VDC—24 VDC Converter / 10 Amp	\$442.79

**DC-DC POWER CONVERTERS:
ISOLATED RACKMOUNT WIDE RANGE SERIES (12 VOLT)**

Product #	Description	Price
ICT2060-12AIR	20-60VDC—12 VDC Converter / 12 Amp	\$371.36
ICT2060-20AIR	20-60VDC—12 VDC Converter / 20 Amp	\$528.50
ICT50100-12AIR	50-100VDC—12 VDC Converter / 12 Amp	\$371.36
ICT50100-20AIR	50-100VDC—12 VDC Converter / 20 Amp	\$471.36

**DC-DC POWER CONVERTERS:
ISOLATED RACKMOUNT WIDE RANGE SERIES (24 VOLT)**

Product #	Description	Price
ICT206024-5AIR	20-60VDC—24VDC Converter / 5 Amp	\$385.64
ICT206024-10AIR	20-60VDC—24 VDC Converter / 10 Amp	\$485.64
ICT5010024-5AIR	50-100VDC—24 VDC Converter / 5 Amp	\$385.64
ICT5010024-10AIR	50-100VDC—24 VDC Converter / 10 Amp	\$485.64

Primus conveniently offers same day shipping on in-stock orders placed by 4:00 pm CST. To place an order, call us today at (800) 435-1636 or email sales@primuselectronics.com

Visit us online at www.primuselectronics.com

POWER SUPPLIES

DESKTOP



SPS-1204UL

Product #	Description	Price
SPS-1204UL	Input 115V, Output 13.2V, 3.5 amps w/cig plug; 2 year warranty	\$25.95
SPS-1206	Input 115V, Output 13.2V, 5.5 amps w/cig plug; 2 year warranty	\$32.82
SEC-1212	Input 115/230V, Output 13.8V, 10 amps; 3 year warranty	\$72.65
SEC-1223	Input 115 / 230V, Output 13,8V, 23 amps; 3 year warranty	\$105.60

RACKMOUNT

Product #	Description	Price
N+1 Power System: High Amp Rackmount DC supply with Battery back-up. 117 VAC input, 13.8 VDC regulated output c/w meters + LED indicators. N+1 Product also available with 220VAC input at same pricing.		
SEC-40BRM	19" Rack, 40 amp power supply, N+1 redund.; 2 year warranty	\$322.15
SEC-60BRM	19" Rack, 60 amp power supply, N+1 redund.; 2 year warranty	\$363.35
SEC-80BRM	19" Rack, 80 amp power supply, N+1 redund.; 2 year warranty	\$418.26
SEC-100BRM	19" Rack, 100 amp power supply, N+1 redund.; 2 year warranty	\$473.17
SEC-2450BRM	19" Rack, 50 amp power supply, N+1 redund.; 2 year warranty. 117 VAC input, 27.6 VDC regulated output—c/w meters + LED indicators	\$500.65

LINEAR DC POWER SUPPLIES



RPS-1203



SEC-6

Product #	Description	Price
RPS-1203	3A cont., 5A ICS; 2 year warranty	\$22.25
RPS-1203UL	3A cont., 5A ICS, UL/CSA approved; 2 year warranty	\$29.45
RPS-1204CPBT	4A cont., 6A ICS, c/w female cigar. recept., 2 year warranty	\$25.45
RPS-1207	7A cont., 10A ICS; 2 year warranty	\$42.90
RPS-1210UL	10A cont., 14A ICS, UL/CSA approved; 2 year warranty	\$63.20
RPS-1220	20A cont., 25A ICS; 2 year warranty	\$103.85
SEC-6	4Acont., 6A ICS, c/w female cigar. recept.; 2 year warranty	\$27.05
SEC-11	8A cont., 11A ICS; 2 year warranty	\$49.45
SEC-14	10A cont., 14A ICS; 2 year warranty	\$62.25
SEC-20	15A cont., 20A ICS; 2 year warranty	\$81.45
SEC-25	20A cont., 25A ICS; 2 year warranty	CALL

**Additional SEC linear models available with 220V input at same pricing*

POWER SUPPLIES

COMMUNICATIONS APPLICATIONS

Product #	Description	Price
SDC-5	20-32V input, 12V output, 5A; 2 year warranty	\$29.25
SDC-15	20-30V input, 12V output, 12A; 2 year warranty	\$54.80
SDC-23	20-30V input, 12V output, 20A; 2 year warranty	\$68.55
SDC-20	20-30V input, 13.8V output, 15A; 2 year warranty. Class 1 Div 2 CSA Certified	\$82.25
SDC-30	20-30V input, 12V output, 30A; 2 year warranty	\$88.05



SDC-5

FULLY ISOLATED 72-12 CONVERTERS

Product #	Description	Price
SD-25C-12	25 Watt Output. 36-72V input, 12V output, 2.1A; 2 year warranty	\$35.67
SD-25C-24	25 Watt Output. 36-72V input, 24V output, 1.1A; 2 year warranty	\$35.67
SD-50C-12	50 Watt Output. 36-72V input, 12V output, 4.2A; 2 year warranty	\$43.30
SD-50C-24	50 Watt Output. 36-72V input, 24V output, 2.1A; 2 year warranty	\$43.30
SD-150D-12	150 Watt Output. 72-144V input, 12V output, 12.5A; 2 year warranty	\$73.70
SD-150D-24	150 Watt Output. 72-144V input, 24V output, 6.3A; 2 year warranty	\$73.70
SD-200D-12	200 Watt Output. 72-144V input, 12V output, 16.7A; 2 year warranty	\$135.65
SD-200D-24	200 Watt Output. 72-144V input, 24V output, 8.4A; 2 year warranty	\$135.65
SD-350D-12	350 Watt Output. 72-144V input, 12V output, 27.5A; 2 year warranty	\$160.80
SD-350D-24	350 Watt Output. 72-144V input, 24V output, 14.6A; 2 year warranty	\$160.80

**Can't find what you are looking for?
Give us a call, we are happy to help locate the item you need.**

Visit us online at www.primuselectronics.com

POWER SUPPLIES

DESKTOP LP SERIES



LP Series

Product #	Description	Case	List	Dealer	Case
LP-10	10 Amp int. /7 Amp cont.	10	\$84.00	\$61.00	\$63.00
LP-14	14 Amp int./11 Amp cont.	10	\$99.00	\$72.00	\$74.00
LP-18	18 Amp int./14 Amp cont.	10	\$123.00	\$90.00	\$92.00
LP-25	25 Amp int./22 Amp cont.	10	\$160.00	\$118.00	\$120.00

LP ACCESSORIES AND CUSTOM HOODS



LPBC Battery Backup Module

Product #	Description	Case	List	Dealer	Case
LPBC-25	Battery Backup Module	1	\$20.00	\$15.00	\$15.00
LPH-MOT/L	Motorola Radius M120	5	\$20.00	\$15.00	\$15.00
LPH-MOT/S	Motorola Radius M120	5	\$20.00	\$15.00	\$15.00
LPH-KEN/L	Kenwood "30" Series	5	\$20.00	\$15.00	\$15.00
LPH-KEN/S	Kenwood "60" Series	5	\$20.00	\$15.00	\$15.00
LPH-ICOM 221S	ICOM	5	\$20.00	\$15.00	\$15.00
LPH-MAX/GE	Maxon/GE SM2000/Monogram	5	\$20.00	\$15.00	\$15.00
LPH-BENKING	Bendix King	5	\$20.00	\$15.00	\$15.00
LPH-MOTIDEN	Motorola Iden	5	\$20.00	\$15.00	\$15.00
LPH-MOT-CDM	Motorola/CDM	5	\$20.00	\$15.00	\$15.00



LPH Low Profile Hood

STAND ALONE OR RACK MOUNT—DPS SERIES

Product #	Description	Case	List	Dealer	Case
DPS-15	15 Amp Power Supply	6	\$154.00	\$114.00	\$115.00
DPS-30	30 Amp Power Supply	6	\$200.00	\$148.00	\$150.00
DPS-45	45 Amp Power Supply	6	\$264.00	\$196.00	\$198.00
DPS-55	55 Amp Power Supply	6	\$292.00	\$217.00	\$219.00
DPS-75	75 Amp Power Supply	4	\$450.00	\$335.00	\$337.00
IQ-4	Int. Smart Charger	1	\$51.00	\$38.00	\$38.00
SL-RACK	Slimline Rack Panel	1	\$46.00	\$34.00	\$34.00

For additional Duracomm products, please contact Primus

Toll-Free (800) 435-1636 • Fax (800) 767-7605

COAXIAL PROTECTORS

BROADBAND HF/VHF/UHF/COAXIAL PROTECTORS—FLANGE MOUNT

Product #	Description	Price
UHF CONNECTORS (FEMALE STANDARD)		
IS-50UX-Co	< 10 mJ Throughput Energy, Freq range: 1.5 MHz to 400 MHz, Max Power: HF 2kW, VHF 375W, UHF 125W	\$62.00
IS-50UX-C1	< 600 uJ Throughput Energy, Freq range: 50 MHz to 700 MHz, Max Power: VHF 375W, UHF 125W	\$62.00
N CONNECTORS (FEMALE STANDARD)		
IS-50NX-Co	< 10 mJ Throughput Energy, Freq range: 1.5 MHz to 400 MHz, Max Power: HF 2kW, VHF 375W, UHF 125W	\$62.00
IS-50NX-C1	< 600 uJ Throughput Energy, Freq range: 50 MHz to 700 MHz, Max Power: VHF 375W, UHF 125W	\$62.00
IS-50NX-C2	< 220 uJ Throughput Energy, Freq range: 125 MHz to 1000 MHz, Max Power: VHF 375W, UHF (low) 125W, 800 MHz to 1 GHz 50W	\$62.00

BROADBAND HF/VHF/UHF/COAXIAL PROTECTORS—BULKHEAD MOUNT

N CONNECTORS (FEMALE STANDARD)

IS-B50LN-Co	< 10 mJ Throughput Energy, Freq range: 1.5 MHz to 400 MHz, Max Power: HF 2kW, VHF 375W, UHF 125W	\$65.00
IS-B50LN-C1	< 600 uJ Throughput Energy, Freq range: 50 MHz to 700 MHz, Max Power: VHF 375W, UHF 125W	\$65.00
IS-B50LN-C2	< 220 uJ Throughput Energy, Freq range: 125 MHz to 1000 MHz, Max Power: VHF 375W, UHF (low) 125W, 800 MHz to 1 GHz 50W	\$65.00

Female Connectors are standard on all units. Male Connectors can be provided.

Add suffix “-MA” for male on antenna port , “-ME” for male on equipment port.

IN-LINE TWISTED PAIR PROTECTORS

Product #	Description	Price
IS-T1	T1 Data, 4 Wire Protector/36KA Surge	\$154.00
IS-3T1	T1 Data, 12 Wire Protector/36KA Surge	\$377.00
IS-SPTL	Single Protector, Telco Trunks	\$7700
IS-DPTL	Dual Protector, Telco Trunks	\$117.00

POWER LINE EXTENSION PROTECTORS—120/240 VAC

Product #	Description	Price
PLDO-120US15A	For 120 Vac with 15' cord, 15 Amps	\$182.00
PLDO-120US20A	For 120 Vac with 6' cord, 20 Amps	\$227.00

Visit us online at www.primuselectronics.com

LOCOMOTIVE ANTENNAS



EXCAL321A

The Sinclair Excaliber Series of Low Profile Antennas are designed for locomotive applications.

Model 321A covers the E.O.T. UHF transmit and receive frequencies that are utilized for data communications.

EXCALIBER SERIES

Product No.	Description	Price
ST221-SF1SUF (F1610)	Previous Product No. Excal221A—148-174 MHz, Excaliber Low Profile Antenna. 161.000 MHz Center frequency in stock. Order Cable Kit Separately.	\$247.00
ST321-SF4SUF	Previous Product No. Excal321A.—406-512 MHz, Excaliber Low Profile Antenna for radio communications and E.O.T. telemetry. Order Cable Kit Separately.	\$112.50
ST321R-SF3SNF (CWH)	Previous Product No. Excal321R.—406-512 MHz, Excaliber Low Profile Antenna with radome for radio communications and E.O.T. telemetry. Order Cable Kit Separately.	\$125.25
RG8	Belden 8214 Stranded Coax. 25' is a normal length	\$1.03/ft
RFU-501	Connector, 2 required	\$2.04/ea
RFU-531	Connector, 2 required	\$0.33/ea

ST221 SPECIFICATIONS

Mechanical		Electrical	
Height	4"	Frequency Range	161.000 MHz Center frequency. Other ranges available.
Width	2.2"	Polarization	Vertical
Length	25"	Pattern	Omni-Directional
Weight	6.0 lbs	Gain	Unity
		Termination	UHF Female

Can't find a product you are looking for? We offer products from over 100 manufacturers. Give us a call, we will find the product you need!

LOCOMOTIVE ANTENNAS

Primus16 Locomotive Antenna Footprint replaces the ASP16

The ASP16 Loco Antenna (VHF Radio) that has been around for 40 years is now obsolete and is no longer available! According to the manufacturer, this antenna, otherwise know as beer can or firecracker antenna is gone forever.

Primus is now offering a direct replacement footprint—mount portion—as PRIMUS16 at \$65.00. The replacement footprint is in stock and has a NMO/TAD mount that almost any antenna will mount to (mobile type mount).

The footprint PRIMUS16 may be used for UHF (telemetry HTD), cell phone or any other type of antennas. It can also be installed on other types of heavy duty railroad equipment.



PRIMUS16



ASP-16

LOCOMOTIVE ANTENNA FOOTPRINT

Product #	Description	Price
PRIMUS16	Footprint replacement, mount portion, for ASP16	\$65.00

VHF RADIO ANTENNAS

Product #	Description	Price
B132S	Antenex—Heavy duty spring and heavy duty rod. Includes cutting chart.	\$16.44
QW152	Antenex—1/4 Wave Antenna with rod and chrome ring. No spring.	\$3.83
A1511A-161	Comtelco—Heavy duty spring and heavy duty rod. Chrome.	\$15.00
A1511B-161	Comtelco—Heavy duty spring and heavy duty rod. Black.	\$18.00
A1211A-152	Comtelco—1/4 Wave Antenna with .062 rod and chrome ring. No spring.	\$4.00
MWB1320	PCTEL (Maxrad) - Heavy duty spring and heavy duty rod. Rod requires cutting to frequency. Chart included.	\$15.72
MHB1520	PCTEL (Maxrad) - 1/4 Wave Antenna with rod and chrome ring.	\$3.79
NMOWBQC	Radiall Larsen—Heavy duty spring and heavy duty rod.	\$18.00
NMOQW	Radiall Larsen—1/4 Wave Antenna with rod and chrome ring. No spring.	\$4.00

Visit us online at www.primuselectronics.com

BASE STATION ANTENNAS

VHF BASE STATION ANTENNAS

New Product #	Previous Product #	Description	Price
SD210SF2P2SNM	SRL-210C*2	138-174 MHz Exposed Dipole-Fixed Pattern Antenna, 1/2 Wave, N-Male Conn.	\$223.50
SD210SF2P4SNM	SRL-210C*4	138-174 MHz Exposed Dipole-Fixed Antenna, 1/4 Wave, N-Male Conn.	\$223.50
SD212SF2P2SNM	SRL-210C2*2	138-174 MHz Exposed Dipole-Fixed Pattern Antenna Array, 1/2 Wave, N-Male Conn.	\$495.00
SD212SF2P4SNM	SRL-210C2*4	138-174 MHz Exposed Dipole-Fixed Pattern Antenna Array, 1/4 Wave, N-Male Conn.	\$495.00
SC229-SFXSNM	SRL-229-1590	138-174 MHz Omni-directional Antenna, N-Male Conn. (specify center freq.)	\$881.25

UHF BASE STATION ANTENNAS

New Product #	Previous Product #	Description	Price
SD310-HF2P2SNM	SRL-310C2*2	406-512 MHz Exposed Dipole-Fixed Pattern Antenna Array, 1/2 wave, N-Male Conn.	\$225.75
SD314-HF2P2SNM	SRL-310C4*2	406-512 MHz Exposed Dipole-Fixed Pattern Antenna Array, 1/2 wave, N-Male Conn.	\$682.50
SC320-SF35NM	SRL-320*3	460-470 MHz Omni-directional Antenna, N-Male Conn.	\$1,020.75

800-900 MHZ BASE STATION ANTENNAS

New Product #	Previous Product #	Description	Price
SP440-SF2SNF	SRL-441U	800-1000 MHz 5dB Low Profile Antenna	\$209.75

PIPE TO PIPE CLAMPS

Clamps	Description	Pipe #1 inside (inches)	Pipe #2 outside (inches)	Price
111	Pipe Parallel to Angle	1.5-3.5 dia	3.5-60 90 dia	\$56.25
113A	Pipe Parallel to Angle	1.5-3.5 dia	4.0-8.0 60 dia	\$69.75
125U	Pipe Parallel to Angle	1.5-3.5 dia	1.5-3.5 dia	\$108.75
5	Pipe Parallel to Pipe	1.5-3.5 dia	1.5-3.5 dia	\$45.00

Primus stocks many models of antennas. If you are looking for a product not listed in the catalog, please call us!

Toll-Free (800) 435-1636 • Fax (800) 767-7605

BASE STATION ANTENNAS AND ACCESSORIES

VHF ANTENNAS

Product #	Description	Price
ASPB 685	155-163 MHz Omni Fiberglass Super "Base Commander" 5 dB	\$690.00
DB222-B	158-166 MHz Exposed Two Folded Dipole Quasi-Omni Antenna, 3/6 dB	\$245.25
DB224-B	155-165 MHz Exposed Four Folded Dipole Quasi-Omni Antenna, 6.0 dB	\$444.00
DB264-B	155-165 MHz 4-Dipole Enclosed Harness Antenna, 6 dB	\$521.25

UHF ANTENNAS

ASP 705K	450-470 MHz Omni Fiberglass Super Base Commander®, 10 dB	\$825.00
----------	----------------------------------------------------------	----------

800-960 MHZ ANTENNAS

DB580-Y	890-960 MHz Omni Mirage® (Integral Mount Included), Unity	\$262.50
DB583-Y	890-960 MHz Omni Mirage® (Integral Mount Included), Unity	\$318.75

MOUNTING HARDWARE AND ACCESSORIES

DB365-OS	Mounting Clamp Kit Set of 2 (1.25" to 3.5" round or 3" angle)	\$44.25
DB365-SP5	Mounting Clamp Kit Set of 2 (5" Round or 3.54" angle)	\$69.00
DB365W	Mounting Clamp Kit for wood pole or masonry wall up to 14" thickness	\$60.00
DB5001	Side Mount Kit for DB222, DB224, DB264 and DB304 (includes top sway brace)	\$153.75
DB5007	Side Mount Kit for DB404, DB536, DB580 and DB553 (bottom brace only)	\$127.50

Stand-off Brackets

24" to 72" Stand-off brackets are ideal for omni antennas. Features a one-piece welded design. Hot dip galvanized steel.

STAND-OFF BRACKETS

S-200	24" Stand-off Bracket, 1-7/8" OD x 24" antenna mounting pipe	\$110.25
S-300	36" Stand-off Bracket, 1-7/8" OD x 24" antenna mounting pipe	\$122.85
S-400	48" Stand-off Bracket, 1-7/8" OD x 32" antenna mounting pipe	\$159.60
S-500	60" Stand-off Bracket, 1-7/8" OD x 32" antenna mounting pipe	\$189.20
S-600	72" Stand-off Bracket, 1-7/8" OD x 32" antenna mounting pipe	\$198.00

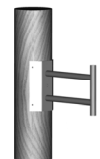

STAND-OFF BRACKET FOR WOOD POLE MOUNTING

MT-C8743	Stand-off Bracket for wood pole mounting	\$128.00
----------	------------------------------------------	----------

MT-C8743
Designed for
Railroads

Visit us online at www.primuselectronics.com

LAND MOBILE ANTENNAS
LAND MOBILE ANTENNAS—ANTENNA SPECIALISTS

Product #	Description	Price
AP-152.3	150-174 MHz "On-Glass" broadband, black, VHF, 15.5' RG-58/U, UHF male	\$33.13
APR-153	150-174 MHz "On-Glass" black, "cellular look-alike", VHF, 15.5' RG-58/U, UHF male	\$39.13
ASP-7455	138-174 MHz Conversion 3dB gain, MOSAIC, elastomer spring, for low profile and Motorola mts	\$21.25
ASP-7655	445-470 MHz Conversion 5dB gain antenna, MOSAIC, elastomer spring, for low profile & Motorola mounts	\$22.50
K-794	Mt kit for tops up to 1/2" thick, MOSAIC & low profile, 3/8"- 3/4" dia.hole, 17' RG-58/U, no conn.	\$10.88

LAND MOBILE ANTENNAS—MAXRAD

Product #	Description	Price
BM-NC	Brass 3/4" mount, 17' RG58A/U NC	\$6.90
BMPL	Brass 3/4" BT RG58U Mini-UHF/crimp	\$7.04
G	Chrome mag mount RG58A/U, PL-259/crimp	\$14.21
GPL	Mag mount with Mini-UHF connector	\$14.21
MATH	49" X .100" taper whip	\$4.47
MHB1520	152-162 MHz Unity, Chrome Nut Series	\$3.79
MHB5800	144-174 MHz 3dB, 5/8 Wave	\$14.74
MHB5802	144-174 MHz Unity, No Ground Plane	\$14.40
MHB5802S	144-174 MHz Unity, No Ground Plane w/spring	\$18.99
MLPVDB800/1900	806-960/1710-1990 MHz LowPro Ant, 154/280 MHz bandwidth, 3 dBi, black over chrome base	\$20.70
MUF4500	450-470 MHz Unity, Chrome Nut Series, Quarterwave	\$3.61
RBG	Black mag mount 12' 58A/U PL259/crimp	\$16.74
TGB-34	3/4" Hole trunk groove "L" bracket	\$1.97
MLB4000	Low Band	\$16.56

LAND MOBILE ANTENNAS

LAND MOBILE ANTENNAS—RADIALL LARSEN

Product #	Description	Price
GPSNMO02	Black GPS mobile antenna with NMO mount	\$40.00
NMO150BCO	144-174 MHz NMO Coil, 3dB	\$11.80
NMOMMR	NMO Mag Mount, 12' CX, UHF Type Connector	\$19.25
TMB34	Chrome TMB 3/4" Mount	\$3.00
NMO150B	144-174 MHz Coil/Whip, 3dB, .100 Dia Black Whip	\$18.90
NMOKUD	NMO Mount, 17' UD, No Connector	\$12.20
NMO150BK	144-174 MHz Coil/Whip, 3dB, 17' CX, PL-259, .100 Dia Black Whip	\$28.30
NMO150CK	144-174 MHz Coil/Whip, 3dB, 17' CX, PL-259, .100 Dia Chrome Whip	\$25.85
NMOMMRPL	NMO Mag Mount, 12' coax, W/PL259	\$19.35
SPRING	Chrome Shock Spring	\$6.50
SPRING B	Black Shock Spring	\$8.50
W490	27-174 MHz Whip, 5/8 wave, .100 Dia Chrome Whip, 49"	\$4.95
NMO40C	Coil/Whip, Unity, 40-50 MHz, .100 Dia Chrome Whip	\$18.35
W540	Whip, 5/8 or 1/4 wave, 27-174 MHz, .100 Dia Chrome Whip, 54"	\$6.20

Primus conveniently offers same day shipping on in-stock orders placed by 4:00 pm CST. To place an order, call us today at (800) 435-1636 or email sales@primuselectronics.com

Visit us online at www.primuselectronics.com

CABLE AND ACCESSORIES

1/4" FLEXIBLE CABLE AND CONNECTORS



41SP



F1PNR-HC

Product #	Description	Price
FSJ1-50A	1/4" Flexible Foam Dielectric, FSJ Series - 50-ohm, standard jacket	\$0.91
FSJ1-50A-RP	500 Foot Reel Pax Carton	\$468.93
F1PNMV2-H	N Male, Hex Head, Solder, Self-Clamping, SG	\$13.57
F1PNM-HC	N Male, Solder, Tab Flare, SG	\$18.63
F1PNR-HC	N Male, Right Angle, Hex Head, Captivated, Self-Clamping, SG	\$18.97
F1PBM-C	BNC Male, Solder, Self-Clamping, SS	\$8.47
41SP	UHF Male, Solder, Solder, BB	\$12.14
F1MU	Mini-UHF Male, Captivated, Crimp, NS	\$12.15

1/2" FLEXIBLE CABLE, CONNECTORS AND ACCESSORIES

Product #	Description	Price
FSJ4-50B	1/2" Flexible Foam Dielectric, FSJ Series - 50-ohm, standard jacket	\$2.03
FSJ4-50B-RP	250 Foot Reel Pax Carton	\$509.12
F4PNMV2-HC	N Male, Captivated, Self-Flare, SG	\$22.02
F4PNR-HC	N Male, Right Angle, Hex Head, Captivated, Crush-Flare, SG	\$35.11
CPT-F4	EASIAX® Plus Automated Cable Prep Tool	\$125.69
CPT-BK	EASIAX® Plus Replacement Blade Kit for CPT-F4	\$92.74
MCPT-1412	EASIAX® Cable Prep Tool for 1/4" and 1/2" cable	\$17.96

7/8" HELIAX® CABLE AND CONNECTORS

Product #	Description	Price
LDF5-50A	7/8" Foam Dielectric, LDF Series - 50-ohm, standard jacket	\$3.20
L5PNM-RPC	N-Male, One Piece, Captivated, Self-Flare, SG	\$28.89
L5TNF-PS	N Female, Self-Tapping, Self-Flare, BB	\$27.55
L5PNF-RPC	N-Female, One Piece, Captivated, Self-Flare, SG	\$28.89

CABLE AND ACCESSORIES

1/2" HELIAX® CABLE, CONNECTORS AND ACCESSORIES

Product #	Description	Price
LDF4-50A	1/2" Foam Dielectric, LDF Series - 50-ohm, standard jacket	\$1.39
L4PNM-RC	N Male, RingFlare™, Captivated, RingFlare, SG	\$17.51
L4PNF-RC	N Female, RingFlare, Captivated, RingFlare, SG	\$17.51
43211A	Standard Hangers Kit of 10 (3 feet maximum spacing)	\$15.77
SSH-12	SnapStack™ Snap-in Hangers Kit of 10	\$18.20
L4SGRIP	Grip with One Clamp (use at 200 feet intervals)	\$14.12
43094	Standard Hoisting Grip	\$15.40
241088-1	Standard Grounding Kit (factory attached one-hole lug, 24" lead)	\$15.50
SGL4-06B2	Sure Ground Grounding Kit (factory attached two-hole lug, 24" lead)	\$14.74
SGL4-10B2	Sure Ground Grounding Kit (factory attached two-hole lug, 39" lead)	\$15.93
CPT-L4ARC1	EASIAX® Plus Automated Cable Prep Tool	\$176.84
CPT-BKS1	Replacement Blade Kit for CPT-L4ARC1	\$50.25
MCPT-L4	EASIAX® Cable Prep Tool for 1/2" cable	\$17.96
MCPT-BK4	Replacement Blade Kit for CPT-L4ARC1	\$8.37



L44P



L4PNM-RC



L4PNF-RC

**Primus is a Full Line Stocking Certified Distributor of Andrew products.
If you are looking for a product not listed in the catalog, please call us!**

50 OHM BRAIDED CABLE

Product #	Description	Price/Foot
WBC-195	RG-58, 50 Ohm Braided Cable	\$0.28
WBC-200	50 ohm Braided Cable	\$0.33
WBC-240	RG-8x, 50 Ohm Braided Cable	\$0.41
WBC-400	3/8", 50 Ohm Braided Cable	\$0.47
WBC-600	1/2", 50 Ohm Braided Cable	\$1.10



Visit us online at www.primuselectronics.com

CABLE AND ACCESSORIES**1/4" FLEXIBLE CABLE AND ACCESSORIES**

Product #	Description	Price
NKRFF01400	1/4" Superflexible coaxial cable - 50 ohm - black LD polyethylene jacket. Order 1000+ \$0.83/each	\$0.95
NKC2014120	RFF - 1/4" Superflexible, DIN 7-16 Male Connector	\$38.44
NKC2014220	RFF - 1/4" Superflexible, DIN 7-16 Female Connector	\$38.44
NKC2014320	RFF - 1/4" Superflexible, N Male Connector	\$25.00
NKC2014420	RFF - 1/4" Superflexible, N Female Connector	\$25.00
NKC2014620	RFF - 1/4" N-Male Right Angle Connector	\$39.87
NKA1007	RFF - 1/4" Superflex Cable Connector Tool	\$197.85

1/2" FLEXIBLE CABLE AND ACCESSORIES

Product #	Description	Price
NKRFF01200	1/2" Flexible coaxial cable - 50 ohm - black LD polyethylene jacket. Order 1000+ \$1.53	\$1.77
NKC2012120	RFF - 1/2" Flexible, DIN 7-16 Male Connector	\$22.52
NKC2012220	RFF - 1/2" Flexible, DIN 7-16 Female Connector	\$22.52
NKC2012320	RFF - 1/2" Flexible, N Male Connector	\$22.52
NKC2012420	RFF - 1/2" Flexible, N Female Connector	\$22.52
NKC2012620	RFF - 1/2" N-Male Right Angle Connector	\$43.42
NKC2012520	RFF - 1/2" D-Male Right Angle Connector	\$38.63
NKA1009	RFF - 1/2" Flexible Cable Connector Tool	\$115.62
NKA22012	RFF - 1/2" Flexible, Drill Mountable Cable Prep Tool	\$154.45

5/8" FLEXIBLE CABLE AND ACCESSORIES

Product #	Description	Price
NKRF05800	5/8" Feeder coaxial cable - 50 ohm - black polyethylene jacket. Order 1000+ \$2.15/each	\$2.48
NKC1058300	RF - 5/8" Feeder, N-Male Connector	\$41.11
NKC1058400	RF - 5/8" Feeder, N-Female Connector	\$41.11
NKA12058	RF - 5/8" Feeder Drill Mountable Cable Prep Tool	\$186.21

CABLE AND ACCESSORIES

1/2" FEEDER CABLE AND ACCESSORIES

Product #	Description	Price
NKRF01200	1/2" Feeder coaxial cable - 50 ohm - black polyethylene jacket. Order 1000+ \$1.08/each	\$1.25
NKC1012100	RF - 1/2" Feeder, DIN 7-16 Male Cable Connector	\$19.62
NKC1012200	RF - 1/2" Feeder, DIN 7-16 Female Cable Connector	\$19.62
NKC1012300	RF - 1/2" Feeder, N-Male Cable Connector	\$19.62
NKC1012400	RF - 1/2" Feeder, N-Female Cable Connector	\$19.62
NKC1012500	RF - 1/2" Feeder, DIN 7-16 Male Right Angle Cable Connector	\$32.21
NKC1012600	RF - 1/2" Feeder, N-Male Right Angle Cable Connector	\$32.21
NKA1001	RF - 1/2" Feeder Cable Connector Tool	\$88.88
NKA12012	RF - 1/2" Feeder Drill Mountable Cable Prep Tool	\$186.21

7/8" FEEDER CABLE AND ACCESSORIES

Product #	Description	Price
NKRF07800	7/8" Feeder coaxial cable - 50 ohm - black polyethylene jacket. Order 1000+ \$2.11/each	\$2.43
NKC1078100	RF - 7/8" Feeder, DIN 7-16 Male Connector	\$25.32
NKC1078200	RF - 7/8" Feeder, DIN 7-16 Female Connector	\$25.32
NKC1078300	RF - 7/8" Feeder, N-Male Connector	\$25.32
NKC1078400	RF - 7/8" Feeder, N-Female Connector	\$25.32
NKA1003	RF - 7/8" Feeder Connector Tool	\$88.88
NKA12078	RF - 7/8" Feeder Drill Mountable Cable Prep Tool	\$186.21

1-1/4" and 1-5/8" Cable Also Available. Call for more information.

In addition to the Cables and Accessories listed in the catalog, 1-1/4" and 1-5/8" Cable is also available, please call for more information.

LMR® CABLES AND CONNECTORS

LMR-240

Product #	Description	Price
LMR-240	1/4" Flexible Foam Dielectric, 50 Ohms, standard jacket	\$0.44
LMR-240-DB	1/4" Flexible Foam Dielectric, 50 Ohms, watertight cable	\$0.50
TC-240-NMH	N Male, Hex Head, Solder, Crimp N/S	\$5.63
EZ-240-NM	N Male, Knurl Head, Non-Solder, Crimp, N/G	\$5.85
TC-240-NM-RA(A)	N Male, Right Angle, Hex Head, Solder, Crimp, A/G	\$11.25
TC-240-BM(A)	BNC Male, Knurl Head, Solder, Crimp, A/G	\$5.63
TC-240-MUHF	Mini-UHF Male, Knurl Head, Solder, Crimp, N/G	\$2.44
CT-240/200/100	Crimp Tool for LMR-240 Connectors	\$100.50

LMR-600

Product #	Description	Price
LMR-600	1/2" Flexible Foam Dielectric, 50 Ohms, standard jacket	\$1.21
LMR-600-DB	1/2" Flexible Foam Dielectric, 50 Ohms, watertight cable	\$1.34
EZ-600-NMC-2	N Male, Hex Head, Non-Solder, Crimp S/S	\$15.68
TC-600-NFC-BH	N Female Bulkhead, Solder, Clamp, S/G	\$20.93
TC-600-UMC	UHF Male, Knurl Head, Solder, Clamp, S/G	\$24.08
ST-600C	Cable Prep Tool for LMR-600 & LMR-600-DB	\$68.25
GK-S600T	Standard Grounding Kit	\$20.25

LMR-400

Product #	Description	Price
LMR-400	3/8" Flexible Foam Dielectric, 50 Ohms, standard jacket	\$0.62
LMR-400-DB	3/8" Flexible Foam Dielectric, 50 Ohms, watertight cable	\$0.69
TC-400-NMH	N Male, Hex Head, Solder, Crimp, S/G	\$6.45
EZ-400-NMH	N Male, Hex Head, Non-Solder, Crimp, S/G	\$6.75
EZ-400-NMH-RA	N Male, Right Angle, Hex Head, Non-Solder, Crimp, S/G	\$17.70
TC-400-BM	BNC Male, Knurl Head, Solder, Crimp, N/G	\$7.88
TC-400-MUHF	Mini-UHF Male, Knurl Head, Solder, Crimp, N/G	\$2.63
EZ-400-UM	UHF Male, Knurl Head, Non-Solder, Crimp, N/G	\$11.25
ST-400EZ	Cable Prep Tool for LMR-400 & LMR-400-DB	\$68.25
GK-S400T	Standard Grounding Kit	\$20.25
CT-400/300	Crimp Tool for LMR-400 Connectors	\$100.50

LMR-900

Product #	Description	Price
LMR-900-DB	5/8" Flexible Foam Dielectric, 50 Ohms, watertight cable	\$3.45
EZ-900-NMC-2	N Male, Hex Head, Non-Solder, Clamp, S/S	\$38.25
EZ-900-NFC-2	N Female, Non-Solder, Clamp, S/S	\$38.25
ST-900C	Cable Prep Tool for LMR900-DB	\$44.25
GK-S900T	Standard Grounding Kit	\$22.50

CABLE ACCESSORIES

Universal Snap-in Hangers

Snap-in hangers are typically installed directly into coax ladder rungs, stand-offs or angle adapters designed to accept snap-ins. Provides for fast installation of coax. .

UNIVERSAL SNAP-IN HANGERS

Product #	Description	Price
252113	Universal Snap-in Hanger Kit for 1/2" coax (10/Kit)	\$11.09
252115	Universal Snap-in Hanger Kit for 7/8" coax (10/Kit)	\$11.72

Butterfly Hangers

Provide coaxial cable support. Available for 1/2" to 1-1/4" coaxial cable. Bolt-on single run hanger. Stainless steel.

BUTTERFLY HANGERS

Product #	Description	Price
252119	Butterfly Hanger Kit for 1/2" coax (10/Kit)	\$7.23
252121	Butterfly Hanger Kit for 7/8" coax (10/Kit)	\$10.34

Cushion Hanger Assemblies

Provide coaxial cable supports. Multi-run cushion hanger handles coaxial cable or elliptical waveguide cable. EPDM rubber.

CUSHION HANGER ASSEMBLIES

Product #	Description	Price
294650	Cushion Hanger Assembly w/1 Hole for 1/2" corrugated coax	\$26.93
294651	Cushion Hanger Assembly w/2 Holes for 1/2" corrugated coax	\$26.93
294652	Cushion Hanger Assembly w/3 Holes for 1/2" corrugated coax	\$26.93
294653	Cushion Hanger Assembly w/4 Holes for 1/2" corrugated coax	\$26.93
294655	Cushion Hanger Assembly w/1 Hole for 7/8" corrugated coax	\$26.93
294656	Cushion Hanger Assembly w/2 Holes for 7/8" corrugated coax	\$26.93
294657	Cushion Hanger Assembly w/3 Holes for 7/8" corrugated coax	\$26.93

Hoisting Grips

Provide coaxial cable supports. Versions available for coaxial and elliptical waveguide. Mesh grip with single eye support; lace-up installation at any point on coaxial cable. Tinned bronze.

HOISTING GRIPS

Product #	Description	Price
252107	Lace-Up Hoisting Grip for 1/2" corrugated, Cell Reach™, Aircell™ and LMR-600 coax	\$11.14
252109	Lace-Up Hoisting Grip for 7/8" corrugated, Cell Reach™, Aircell™ and LMR-1200 coax	\$16.20

Visit us online at www.primuselectronics.com

CABLE ACCESSORIES



Round Member Adapters

Adapts hangers to round members. Slotted hose clamps, 1/2" wide, provide for coax cable support in a variety of applications.

ROUND MEMBER ADAPTERS

294555	Round Member Adapter, 1" - 2" OD, 10 per pack	\$7.03
294556	Round Member Adapter, 2" - 3" OD, 10 per pack	\$7.81
294557	Round Member Adapter, 3" - 4" OD, 10 per pack	\$8.77
294558	Round Member Adapter, 4" - 5" OD, 10 per pack	\$9.07
294559	Round Member Adapter, 5" - 6" OD, 10 per pack	\$12.96
294560	Round Member Adapter, 6" - 8" OD, 10 per pack	\$15.93
RM-A800	Round Member Adapter, 2" - 10" OD, 10 per pack	\$19.80

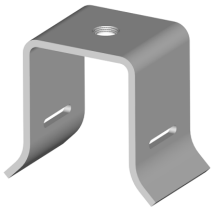

Stand-off Adapters

Adapts hangers to round members. Provides 1" stand-off for 3/4" to 6" members. 3/8" tapped hole; mounts to round pipe. Provides for coax cable support in a variety of applications.

STAND-OFF ADAPTERS

294561	Stand-Off Adapter (kit/10), 3/8" Tapped Hole	\$32.58
30848-5	Stand-Off Adapter for 1"-2" OD (25.4mm-50.8mm OD) members (kit/10)	\$66.00
30848-4	Stand-Off Adapter for 2"-3" OD (50.8mm-76.2mm OD) members (kit/10)	\$66.00
30848-1	Stand-Off Adapter for 3"-4" OD (76.2mm-101.6mm OD) members (kit/10)	\$66.00
30848-2	Stand-Off Adapter for 4"-5" OD (101.6mm-127.0mm OD) members (kit/10)	\$66.00
30848-3	Stand-Off Adapter for 5"-6" OD (127.0mm-152.4mm OD) members (kit/10)	\$66.00
294562	Stand-Off Adapter (kit/10), 3/4" Snap-In Hole	\$32.58
STS-23	Snap-In Tower Stand-Off Adapter for 2"-3" OD (50.8mm-76.2mm OD) members (kit/10)	\$69.91
STS-34	Snap-In Tower Stand-Off Adapter for 3"-4" OD (76.2mm-101.6mm OD) members (kit/10)	\$69.91
STS-45	Snap-In Tower Stand-Off Adapter for 4"-5" OD (101.6mm-127.0mm OD) members (kit/10)	\$69.91

Additional Cable Accessories are available. Can't find what you are looking for? Just call us at (800) 435-1636.

CABLE ACCESSORIES

Angle Adapters

Stainless Steel angle Adapters provide coax support in a variety of applications; allows mounting directly to beams or angle members.



ANGLE ADAPTERS

Product #	Description	Price
252130	Universal angle adapter for 3/8" hardware and snap-in hangers, 10 per pack	\$28.33
294571	Universal snap-in angle adapter, 10 per pack	\$26.33

4" Feed-thru Entry Panels

Entry port solutions that cleanly take cables from outside a building or shelter to the inside. Entry panels are supplied with port caps and mounting hardware. These panels accept the popular sized 4" boot/cushion assembly.

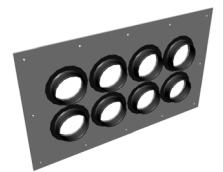

4" FEED-THRU ASSEMBLIES

Product #	Description	Price
252135	4" Feed-Thru Entry Panel, 1 port, 1 x 1, standard. Overall size 7" x 7".	\$14.60
252136	4" Feed-Thru Entry Panel, 4 port, 2 x 2, standard. Overall size 17.5" x 17.5".	\$49.28
252137	4" Feed-Thru Entry Panel, 6 port, 2 x 3, standard. Overall size 23" x 17.5".	\$63.93

4" Boot Assembly Kits

Can be mounted to the Feed-thru entry panels to provide a weather-sealed pass through for cables coming in from the outside. Includes boot, cushion and two hose clamps.



4" BOOT ASSEMBLY KITS

294573	Boot Assembly only	\$14.00
294685	Standard cushion, 1/2", 2 hole. Order boot assembly separately.	\$3.72
294687	Standard cushion, 1/2", 4 hole. Order boot assembly separately.	\$3.72
294698	Standard cushion, 7/8", 2 hole. Order boot assembly separately.	\$3.72
294700	Standard cushion, 7/8", 4 hole. Order boot assembly separately.	\$3.72
252146	Boot Assembly Kit, 4" w/1 Hole for 1/2" corrugated coax	\$18.28
252147	Boot Assembly Kit, 4" w/3 Holes for 1/2" corrugated coax	\$18.28
252150	Boot Assembly Kit, 4" w/1 Hole for 1/2" corrugated coax	\$18.28
252151	Boot Assembly Kit, 4" w/3 Holes for 1/2" corrugated coax	\$18.21

Visit us online at www.primuselectronics.com

TOOL BAGS AND ACCESSORIES

Straight Ahead, Inc. bags were developed to withstand tough conditions

Straight Ahead bags are made of a durable cloth, 1000 Cordura®, a material four times more durable than canvas. The bag bottoms are double reinforced with a flexible upper support that allows the bag to pass through narrow areas. Convenient drawstring closure (optional) helps keep tools inside if bag is tipped. Hardware meets military specs. Multiple choice of colors available to designate equipment by crew. Washable and mildew resistant.

TOOL BAGS

Product #	Description	Price
SAI-101	TOOL BAG. 12" tall, 2 interior pockets, 2 interior elastic straps each divided into sections varying in size. Please choose one of the following options to secure the bag: Attachment A—Snap with flap, Attachment B—Sure link hook (optional strap available—SAI-200), Attachment C—Bar slides with straps	\$59.93
Optional Exterior Pockets	Option D—Long pocket (radio size) Option E—Short pocket (phone size)	
Optional Closure	Option F—Drawstring closure	
Color Options	Red (RD), Navy Blue (NB), Royal Blue (RB), Green (GR), Orange (OR), Yellow (YW)	

OTHER BAGS

SAI-102	GEAR BAG. 16" tall, 28" long, 15" deep. 1 exterior zippered pocket, 1 exterior i.d. slot, removable hard bottom (optional shoulder strap available—SAI-202).	\$90.40
SAI-103	NOSE BAG. 19" tall, drawstring closure. Holds 6 beacon bulbs (optional liner available—SAI-203).	\$41.42
SAI-104	STEEL STACKER NOSE BAG. Same as SAI-103 but constructed from 22 oz. truck tarp and reinforced on the bottom with extra webbing. This bag will handle major abuse!	\$53.74
SAI-105	RADIO BAG. 10.5" tall, 3.5" wide, 2" deep. Permanent padding. Adjustable strap for attachment to harness or belt.	\$18.00
SAI-106	RESCUE DUAL COMPARTMENT BAG. 16" tall, 28" long, 15" deep. 1 exterior zippered pocket. Dual compartment, bottom section designed to hold 300' of rope. Top section holds rescue equipment (optional shoulder strap available—SAI-202).	\$96.56
SAI-107	TIE WRAP BAG. 12" tall. Custom sizes are available.	\$15.45
SAI-108	TIE WRAP BAG. 6" tall. Custom sizes are available.	\$15.45

BAG ACCESSORIES

SAI-201	ACCESSORY STRAP. Designed to secure the Tool Bag with hooks (attachment B) to your harness. Sold in pairs.	\$6.24
SAI-202	SHOULDER STRAP. Designed for use with Gear Bags SAI-102 and SAI-106	\$13.80
SAI-203	ACCESSORY BAG LINER. Removable foam padded liner designed for use with the Nose Bag, SAI-103. Great for bulb protection.	\$6.47
SAI-205	SPUD WRENCH HOLDER. Snap flap secures to belt. Constructed of 22 oz. truck vinyl. Pouch holds wrench; flap secures spud wrench when not in use.	\$23.16

COMMUNICATION SPEAKERS

ALUMINUM COMMERCIAL PA HORNS

Product #	Description	Price
SPC-8	5" Round 15W weatherproof aluminum PA horn	\$9.54
SPC-10	6" Round 15W weatherproof aluminum PA horn	\$17.63
SPC-10/4	6" Round 15W 4 OHM weatherproof aluminum PA horn	\$17.63
SPC-15	8" Round 25W weatherproof aluminum PA horn	\$21.79
SPC-15R	5" x 8" Rectangular 25W weatherproof aluminum PA horn	\$19.75
SPC-20	12" Round 65W weatherproof aluminum PA horn	\$44.74
SPC-20R	8" x 12" Rectangular 65W weatherproof aluminum PA horn	\$45.65
SPC-30	15" Round 75W weatherproof aluminum PA horn	\$52.56

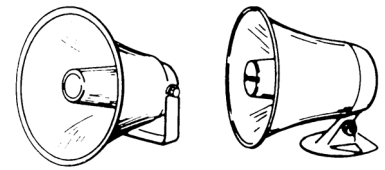

ASPC-20 **SPC-8**

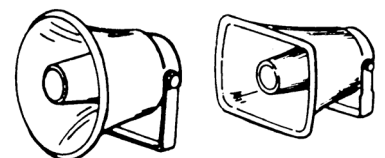

SPC-10 **SPC-15R**

SHOCK-PROOF PLASTIC WEATHERPROOF PA HORNS

Product #	Description	Price
SPC-5P	5" Round white 15W ABS PA speaker w/SS hardware & ABS plastic base (10' cord/3.5mm plug)	\$6.19
SPC-15RP	5" x 8" Rectangular white 30W ABS PA speaker w/SS hardware & ABS plastic base	\$14.51
SPC-40RP	6-1/2" x 11" Rectangular white 40W ABS PA speaker w/universal all position mounting bracket	\$18.15
SPC-60RP	5" x 8" Rectangular white 60W ABS PA speaker w/SS hardware and ABS plastic base	\$29.01

COMMUNICATION SPEAKERS

Product #	Description	Price
AES-4	12V DC Amplified deluxe communications extension speaker w/10' cord & 3.5mm mini plug; 10W	\$29.64
ASPC-20	10-16V DC - 6" Weatherproof ABS plastic Amplified PA speaker; 20W	\$47.84
CBS-100	8 OHM, 5W Mini communications speaker featuring noise limiter. Incl. bracket.	\$7.54
CBS-200	Communications extension speaker w/10' cable & 3.5mm mini plug; 5W	\$8.58
CBS-240	Communications extension speaker w/ABS plastic enclosure; 10' cord & 3.5mm mini plug; 5W	\$10.35
CBS-240W	All weather white marine communications extension speaker; 10' cable & 3.5mm mini plug; 5W	\$11.91
CBS-4	Deluxe communications extension speaker w/10' cord & 3.5mm mini plug; 5W	\$14.51

MICROPHONES AND ACCESSORIES

Product #	Description	Price
MGS-1	Dynamic Gooseneck microphone with push-to-talk. No base. 500 Ohms impedance	\$41.66

Visit us online at www.primuselectronics.com

MOBILE PA AMPLIFIERS, MICROPHONES AND ACCESSORIES

MOBILE PA AMPLIFIERS

Product #	Description	Price
PAT-20TB	20W Mobile PA Amplifier with Talkback feature	\$78.95
PAT-30	Versatile 10W RMS AC/DC Amplifier dual voltage application 117/220V AC	\$111.84
PAT-60	Multi-use 20W RMS AC/DC Amp 12V DC Mobile use or 117/220V AC operation	\$140.79

ATLAS SOUND HORNS AND SPEAKERS

Product #	Description	Price
GA-15T	Utility Paging Horn, 15 Watt	\$56.25
GA-30T	Utility Paging Horn, 30 Watt	\$45.20
RCMR-15	Compact High Efficiency Horn	\$83.78
MO-2	Compact Mobile Communication Loudspeaker	\$96.58

MICROPHONE COVERS

An innovative solution to an old problem

In this ever increasing world of wireless products, so many workers are now using Two-Way radios while performing their jobs. The majority of Two-Way radios are used in outside environments and are subject to all types of weather conditions.

MYKOVER



MYKOVER has a solution for the protection of your radio microphone. MYKOVER has developed a durable cover made of waterproof material designed to fit most Two-Way radio speaker microphones.

The front panel is designed to fit snugly around the microphone. The cover allows sound to travel through while keeping dirt, dust, and moisture out.

Eliminates the use of plastic bags or other awkward, unsafe products used to protect microphones. MYKOVER can extend the useful life of your microphone and contributes to a safer working environment.

Available in orange with yellow reflective strip or black. An opening in the back provides ample room for a rotatable clip. Velcro closures provide for easy placement while securely holding cover on.

MYKOVER—MICROPHONE COVERS

Product #	Description	Price
001	Microphone Cover - Plain Black	\$6.95
003	Microphone Cover - Orange with Yellow Reflective Strip	\$9.95

MYKOVER is available exclusively at Primus Electronics

Toll-Free (800) 435-1636 • Fax (800) 767-7605

RAILROAD HANDSET REPLACEMENT PARTS

MOST COMMON LOCOMOTIVE VERSIONS

Product #	Description	Price
TG-4AAR	Pre-amp microphone black handset with coiled cord; AAR connector	\$73.50
TG-4AARC	Carbon microphone black handset with coiled cord; AAR connector	\$60.00
TG-4AAR-E	Electret microphone black handset with coiled cord; AAR connector; Replacement for Pre-amp version	\$65.00
TG-4AAR-E-16	Electret microphone black handset with 16' cord; AAR connector	\$65.35
1016	Heavy duty rubber hang-up cradle	\$6.50
CORD-16'	16' cord available on all models	\$5.35



Just plug it in and you're in business!

Telephone Components (TCI) manufactures generic replacement handsets for Communications Systems used in Buses, Railroad, Police, Fire and Emergency vehicles. Can also replace all major systems: General Electric, E.F. Johnson, Aerotron & Motorola.

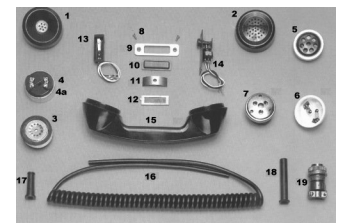

Imprint your "Reporting Marks" at no charge.

RAILROAD HANDSET REPLACEMENT PARTS

Product #	Description	Price	Product #	Description	Price
741CP	Stainless steel switch plate	\$0.75	DR01V	Dynamic Receiver Cartridge w/ varsitor	\$3.25
741CS	Brass actuator spring	\$0.50	EMS94	Carbon Equivalent Electret Transmitter	\$6.50
741FG	Flat actuator gasket	\$1.35	NP5/10	5 Conductor Hvy. Duty Coil Cord	\$12.25
741PB	Black plastic push bar	\$0.30	NP510ST	5 Conductor Hvy. Duty Coil Cord Stripped and Tinned	\$14.25
741PBTS	Push button toggle switch	\$8.75	NP510STC	Hvy. Duty Cord Stripped, tinned and Amphonal connector attached	\$26.75
741RE3	Railroad type connector, AAR specs.	\$12.50	RB1	Rubber grommet handset end	\$0.60
741SA	Switch box-includes leaf contacts and soldered leads	\$3.95	SC2	Stainless steel plate screw	\$0.07
74HO1	Black handset handle	\$3.90	ST5D	Pre-amp Transistorized DYNAMIC transmitter cartridge	\$28.50
74R01	Black Plastic Receiver Cap	\$0.65	T100	Carbon Transmitter Cartridge	\$3.25
74T01	Black Plastic Transmitter Cap	\$0.65	T100C	Transmitter Cup	\$0.65
BU1	Rubber grommet connector end	\$0.70			

Visit us online at www.primuselectronics.com

CHESTPACKS AND SPEAKER / MICROPHONE HOLDER

New and Improved BEE® Radio Chestpacks—Now with BREAKAWAY Straps



The new Bee® railroad Chestpack has a unique BREAKAWAY feature. The BREAKAWAY feature is a low profile sewn stud that serves as an attachment point for a unique easy-to-assemble suspender clip. The clip will break away at approximately 10 pounds. The clip swivels in relation to the stud and will naturally swivel to match the appropriate angle made by the criss-cross of the suspender thus preventing the straps from bunching. Available in Black and International Orange.

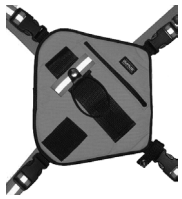

Both models have reflective straps that are 1 inch wide, webbed, all weather, polypropylene with a 3/8 inch wide 3M ScotchLite™ reflective material sewn on the entire length of the strap. During low visibility periods, this results in the effect of a (X) on the back of the Chestpack.

BEE® Model 2362BA-RS Durus Railroad Chestpack has reflective adjustable straps with a BREAKAWAY feature and a radio holder pocket with reflective 3M ScotchLite™ sewn across the pocket. The Chestpack also has a large zipper pouch for holding a switch list or “wheel”, a pen and a Tempilstik. The Chestpack keeps the radio on the chest for maximum hands-free operation. The radio position is at a 45° angle with the antenna held in place by a snap loop. One size fits all. The Chestpack is durable and weather resistant.

RAILROAD RADIO CHESTPACKS

Product #	Description	Price
2362BA-RS/B-IM	Black “Durus” Chestpack w/black reflective straps, breakaway version	\$32.95
2362BA-RS/B	Black “Durus” Chestpack w/black reflective straps, breakaway version (For older model radios)	\$32.95
2362RS/B-IM	Black “Durus” Chestpack w/black reflective straps, standard quick release connectors	\$32.95
2362RS/B	Black “Durus” Chestpack w/black reflective straps, standard quick release connectors (For older model radios)	\$32.95
2362	Black “Durus” Chestpack w/black straps, standard quick release connectors	\$24.95
2362BA-RS/O-IM	International Orange “Durus” Chestpack w/orange reflective straps, breakaway version	\$32.95
2362BA-RS/O	International Orange “Durus” Chestpack w/orange reflective straps, breakaway version (For older model radios)	\$32.95
2362RS/O-IM	International Orange “Durus” Chestpack w/orange reflective straps, standard quick release connectors	\$32.95
2362RS/O	International Orange “Durus” Chestpack w/orange reflective straps, standard quick release connectors (For older model radios)	\$32.95

SPEAKER & MICROPHONE HOLDER

PRIMUS-MHP	Microphone Holder Plus	\$9.95
------------	------------------------	--------



The Primus Microphone Holder Plus is designed to be worn at chest height to protect the user’s clothing while wearing microphones and other devices.

The holder measures 5”x7” and comes with a durable orange mesh material on both sides and a 1mm thick black PVC dividing layer. The orange mesh is nylon sealed in a PVC coating. The nylon strap for attaching the microphone or other devices has a dimension of 1”x5” with a center vertical seam.

The adjustable nylon straps have breakaway clips that detach with 10lb pressure release on each side. The strap has a removable 1-3/4”x6” Neoprene comfort strip to protect your neck.

SAFETY VESTS AND BREAKAWAY STRAPS

Locomotive Remote Control Vest

Made of high quality nylon coated PVC with a mesh vent to let air flow through, the vest is COMPLETELY BREAKAWAY. Available in international safety orange. Meets ANSI II reflective requirements with ANSI II reflective Saturn yellow reflective tape.

The vest has strong nylon adjustable straps attached to 4 metal heavy-duty hooks making the vest capable of hooking many different types of locomotive remote controls. Also includes 2 suspender clips which can be used to attach the back of the vest to the user's belt or pants keeping the vest from shifting when heavy devices are attached to the front.

LOCOMOTIVE REMOTE CONTROL VEST

Product #	Description	Price
LRC-VEST-S	Locomotive Remote Control Vest (Small)	\$48.95
LRC-VEST-M/L	Locomotive Remote Control Vest (Medium / Large)	\$48.95
LRC-VEST-XL	Locomotive Remote Control Vest (X-Large)	\$53.95
LRC-VEST-2X	Locomotive Remote Control Vest (2X-Large)	\$58.95
LRC-VEST-3X	Locomotive Remote Control Vest (3X-Large)	\$63.95



LRC VEST FRONT



LRC VEST BACK

RADIO SAFETY VEST

Heavy-duty safety vest with radio holder, antenna and speaker / microphone holder. Meets or exceeds ANSI II reflective requirements. COMPLETELY BREAKAWAY.

Product #	Description	Price
RSVS-BA	Radio Safety Vest (Small)	\$43.95
RSVL-BA	Radio Safety Vest (Medium / Large)	\$43.95
RSVX-BA	Radio Safety Vest (X-Large / Tall)	\$47.95



RS VEST FRONT

*Add "/O" to part number for Fluorescent Orange and "/Y" for Saturn Yellow

BREAKAWAY SAFETY STRAPS

Made of high quality webbing and with ample reflective tape, these Breakaway Safety Straps include a nylon strip to fasten clip-on devices like a microphone or cell phone. Also includes heavy-duty suspender clips on the front and back sides in order to clip to apparel or belt.

Product #	Description	Price
SS	Breakaway Reflective Safety Straps	\$34.95
SSH	Breakaway Reflective Safety Straps w/removable universal radio holster	\$41.95
SSLRC	Breakaway Reflective Safety Straps w/locomotive remote control straps	\$41.95
SSLRCH	Breakaway Reflective Safety Straps w/locomotive remote control straps and removable universal radio holster	\$48.95

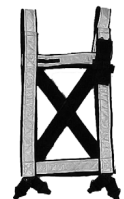

SAFETY STRAP FRONT



SAFETY STRAP BACK

Visit us online at www.primuselectronics.com

BELTS AND BALLISTIC NYLON POUCHES



N100



N100Y

ADJUSTABLE NYLON BELTS

Adjustable Nylon Belt is strong, weather resistant and durable. Features a quick snap release and easy to adjust power glide. Adjustable from 27" to 54" in length. 2" wide belt.

Product #	Description	Price
N100	Heavy-duty Black Nylon Adjustable Belt	\$14.95
N100Y	Nylon with 3M® reflective Saturn yellow tape sewn to the length of the belt	\$24.95

*Add a heavy-duty superior case specifically for your model radio. Starting at \$17.95. Made from American vegetable tanned, top grain, shoulder cowhide. Tanned and finished in the USA.



100



100-Y

EXPANDABLE LEATHER BELTS

Expandable Leather Belt is manufactured by using top grain cowhide of the highest quality. Heavy-duty 2" belt; adjustable from 30" to 52" in length.

100	Heavy-duty Black Leather Belt	\$19.50
100-Y	Leather with 3M® reflective Saturn yellow tape sewn to the length of the belt	\$29.97

*Add a heavy-duty superior case for \$17.95 and up. Made only from American vegetable tanned, top grain, shoulder cowhide. Tanned and finished in the USA.

BALLISTIC NYLON POUCHES

Made with high quality nylon, water repellent coating, and flame adhered lining. Comes with a nylon belt loop with snap closure or a heavy-duty black powder finished metal clip. **To order with metal clip, add -C to product #.**



BP200



BP400



BP500-C



BP600

Product #	Description	Price (Snap)	Price (Clip)
BP600R	Fits the Motorola i830, i836. Approx. dim: 3-3/4" tall x 1-3/4" wide x 1" deep	\$6.95	\$8.95
BP600	Fits the Motorola V60, V66, T720 and similar sized phones. Approx. dim: 3-3/4" tall x 1-3/4" wide x 1" deep	\$6.95	\$8.95
BP400	Fits the Motorola i870, i560, i760, i850, i730 and similar sized phones. Approx. dim: 4" tall x 2-1/2" wide x 1" deep	\$6.95	\$8.95
BP500	Fits the Nokia 3300 Series and similar sized phones. Approx. dim: 4-3/4" tall x 2" wide x 1-1/2" deep	\$6.95	\$8.95
BP200	Fits the Motorola i265, i275, i605, i205, i30, Nokia 5100-6100 series. Approx. dim: 5-1/4" tall x 2-1/4" wide x 1-1/4" deep	\$6.95	\$8.95
BP800	Fits the Motorola i355, i305, i35, i58, i500, i700 and similar sized phones. Approx. dim: 6" tall x 2-1/4" wide x 1-3/4" deep	\$6.95	\$8.95

In addition to the phone models listed, these pouches will fit over 90% of Nextel and other cellular phones.

2-WAY RADIO CASES—LEATHER

KENWOOD RADIO CASES

Product #	Description	Model	Price 1-9	Price 10-24	Price 25+
7220	TH-G71 w/Keypad & PB-39 Batt	THG71	\$ 19.50	\$ 18.25	\$ 16.95
7240	TK2200, 3200 w/KNB-29N Batt	TK 2000, 3000	\$ 20.00	\$ 18.80	\$ 17.50
7237	TK2180, 3180 w/KNB-32N Batt Full Keypad	TK 2000, 3000	\$ 20.00	\$ 18.80	\$ 17.50
7236	TK2180, 3180 w/KNB-33L Batt Full Keypad	TK 2000, 3000	\$ 20.00	\$ 18.80	\$ 17.50
7235	TK2180, 3180 w/KNB-32N Batt	TK 2000, 3000	\$ 20.00	\$ 18.80	\$ 17.50
7234	TK2180, 3180 w/KNB-33L Batt	TK 2000, 3000	\$ 20.00	\$ 18.80	\$ 17.50
7143	TK2100, TK3100 w/KNB-15A Batt	TK 2000, 3000	\$ 20.00	\$ 18.80	\$ 17.50
7142	TK2100, TK3100 w/KNB-14A Batt	TK 2000, 3000	\$ 20.00	\$ 18.80	\$ 17.50
7254	TK5210K w/KNB-32N Batt No Keypad	TK 5210	\$ 20.00	\$ 18.80	\$ 17.50
7255	TK5210K2 w/KNB-32N Batt No Keypad	TK 5210	\$ 20.00	\$ 18.80	\$ 17.50
7256	TK5210K3 w/KNB-32N Batt No Keypad	TK 5210	\$ 20.00	\$ 18.80	\$ 17.50
7054	Tk100, 200, 300 w/Lg Batt	TK x 00	\$ 22.00	\$ 19.80	\$ 18.40
7053	Tk100, 200, 300 w/Stand Batt	TK x 00	\$ 21.00	\$ 19.64	\$ 18.40
7051	TK210, 310 w/800 mAh Batt	TK x 10	\$ 22.00	\$ 19.80	\$ 18.40
7065	TK220, 320 W/KNB-6 Batt. Plain & DTMF	TK x 20	\$ 23.75	\$ 20.90	\$ 18.40
7064	TK220, 320 W/KNB-5 Batt. Plain & DTMF	TK x 20	\$ 21.50	\$ 20.38	\$ 18.84
7061	TK220, 320 W/KNB-7 Batt. Plain & DTMF	TK x 20	\$ 21.50	\$ 20.38	\$ 18.70
7120	TK430, 431 w/DTMF	TK x 30	\$ 23.75	\$ 20.90	\$ 18.40
7119	TK430, 431	TK x 30	\$ 23.75	\$ 20.90	\$ 18.40
7212	TK230, 330SP, w/KNB-4 Batt & Scan	TK x 30	\$ 23.75	\$ 20.90	\$ 18.40
7211	TK230, 330SP, w/KNB-3A Batt & Scan	TK x 30	\$ 23.75	\$ 20.90	\$ 18.40
7115	TK230, 330, w/KNB-4 Batt & DTMF	TK x 30	\$ 23.75	\$ 20.90	\$ 18.40
7114	TK230, 330, w/KNB-3A Batt & DTMF	TK x 30	\$ 23.75	\$ 20.90	\$ 18.40
7113	TK230, 330 w/KNB-4 Batt	TK x 30	\$ 20.00	\$ 18.80	\$ 17.50
7073	TK230, 330 w/KNB-3A Batt	TK x 30	\$ 23.75	\$ 20.90	\$ 18.40
7118	TK240, 340, w/KNB-6 Plain & DTMF	TK x 40	\$ 23.75	\$ 20.90	\$ 18.40
7117	TK240, 340, w/KNB-7 Plain & DTMF	TK x 40	\$ 21.50	\$ 20.38	\$ 18.40
7116	TK240, 340, w/KNB-5 Plain & DTMF	TK x 40	\$ 21.50	\$ 20.38	\$ 18.40

Visit us online at www.primuselectronics.com

2-WAY RADIO CASES—LEATHER

KENWOOD RADIO CASES

Product #	Description	Model	Price 1-9	Price 10-24	Price 25+
7129	TK250, 350, 353 w/KNB-12A Batt Plain & DTMF	TK x 50	\$ 20.00	\$ 18.80	\$ 17.50
7128	TK250, 350, 353 w/KNB-11A Batt Plain & DTMF	TK x 50	\$ 20.00	\$ 18.80	\$ 17.50
7132	TK260, 360, w/KNB-14 Batt	TK x 60	\$ 21.00	\$ 19.64	\$ 18.10
7130	TK260, 360, w/KNB-15A Batt	TK x 60	\$ 20.00	\$ 18.80	\$ 17.50
7147	TK272, 372, 373 w/KNB-15A Batt	TK x 70	\$ 20.00	\$ 18.80	\$ 17.50
7214	TK270, 370 w/KNB-15A & KNB-14A Batt	TK x 70	\$ 20.00	\$ 18.80	\$ 17.50
7224	TK280, 380, 480, w/KNB-17A Batt & DTMF	TK x 80	\$ 20.00	\$ 18.80	\$ 17.50
7223	TK280, 380, 480, w/KNB-16A Batt & DTMF	TK x 80	\$ 20.00	\$ 18.80	\$ 17.50
7219	TK280, 380, 480, w/KNB-16A Batt Plain	TK x 80	\$ 20.00	\$ 18.80	\$ 17.50
7218	TK280, 380, 480, w/KNB-17A Batt Plain	TK x 80	\$ 20.00	\$ 18.80	\$ 17.50
7227	TK190, 290, 390 W/KNB-4 Batt & DTMF	TK x 90	\$ 20.00	\$ 18.80	\$ 17.50
7226	TK190, 290K, 390K w/KNB-17A	TK x 90	\$ 20.00	\$ 18.80	\$ 17.50
7250	TK3170 w/KNB-25A, 26N Batt Full Keypad	Various	\$ 20.00	\$ 18.80	\$ 17.50
7251	TK3170 w/KNB-35L, 40LC Batt Full Keypad	Various	\$ 20.00	\$ 18.80	\$ 17.50
7252	TK3173 w/KNB-25A, 26N Batt Ltd Keypad	Various	\$ 20.00	\$ 18.80	\$ 17.50
7253	TK3173 w/KNB-33L, 40LC Batt Ltd Keypad	Various	\$ 20.00	\$ 18.80	\$ 17.50
7233	TK2140, 3140, 2160, 3160 w/KNB-25A Batt	Various	\$ 20.00	\$ 18.80	\$ 17.50
7232	TK2140, 3140, 2160, 3160 w/KNB-24L Batt	Various	\$ 20.00	\$ 18.80	\$ 17.50
7138	TK3130, 3131, Soft Leather Belt Clip	Various	\$ 13.50	\$ 12.85	\$ 11.75
7124	TH-78, PB-13 Batt	Various	\$ 21.00	\$ 19.64	\$ 18.10

ACCESSORIES FOR KENWOOD & MOTOROLA RADIO CASES

Product #	Description	Price
350	Motorola D-Swivel	\$6.85
345	Motorola Molded Nylon Swivel	\$3.85
360	Low Profile Drop-In Swivel	\$8.80
375	Molded Spring Action Belt Clip ad	\$8.65

Can't find the case you are looking for?

We offer the complete line of Leathersmith Products.

2-WAY RADIO CASES—LEATHER
MOTOROLA RADIO CASES

Product #	Description	Model	Price 1-9	Price 10-24	Price 25+
5110	CP150, CP200 w/NiCad or Li-Ion Batt, No Keypad	CP125, CP150	\$ 18.70	\$ 17.80	\$ 16.80
5196	CT-150, 250, 450 w/No Keypad	CT Series	\$ 23.50	\$ 20.68	\$ 18.84
5197	CT-150, 250, 450 w/Keypad & 4018A Batt	CT Series	\$ 23.50	\$ 20.68	\$ 18.84
5104	EX500 w/High Cap Batt	EX500, EX 600	\$ 18.70	\$ 17.80	\$ 16.80
5101	EX500 w/No Keypad Std Batt	EX500, EX 600	\$ 17.25	\$ 15.80	\$ 14.95
5102	EX600 w/Keypad Std Batt	EX500, EX 600	\$ 18.70	\$ 17.35	\$ 15.95
5107	EX600 w/Ltd Keypad Std Batt	EX500, EX 600	\$ 18.70	\$ 17.80	\$ 16.80
5076	GP300 w/SM Batt & DTMF	GP300	\$ 23.50	\$ 20.68	\$ 18.84
5077	GP300 w/SM Batt	GP300	\$ 23.50	\$ 20.68	\$ 18.84
5078	GP300 w/LG Batt	GP300	\$ 23.50	\$ 20.68	\$ 18.84
5079	GP300 w/LG Batt & DTMF	GP300	\$ 23.50	\$ 20.68	\$ 18.84
5012	GP300, Intrin Safe w/600 mAh Batt	GP300	\$ 23.50	\$ 20.68	\$ 18.84
5013	GP300, Intrin Safe w/1100 mAh Batt	GP300	\$ 23.50	\$ 20.68	\$ 18.84
7078	Radius GP350 w/LG Batt	GP300	\$ 23.50	\$ 20.68	\$ 18.84
7086	Radius GP350 w/LG Batt & Keypad	GP300	\$ 23.50	\$ 20.68	\$ 18.84
5085	HT1000, MTS2000, MTX9000, MTX8000	HT1000, MTS2000, MTX8000, MTX9000	\$ 23.50	\$ 20.68	\$ 18.84
5086	HT1000, MTS2000, MTX9000, MTX8001	HT1000, MTS2000, MTX8000, MTX9000	\$ 23.50	\$ 20.68	\$ 18.84
5087	HT1000, MTS2000, MTX9000, MTX8002	HT1000, MTS2000, MTX8000, MTX9000	\$ 23.50	\$ 20.68	\$ 18.84
5088	HT1000, MTS2000, MTX9000, MTX8003	HT1000, MTS2000, MTX8000, MTX9000	\$ 23.50	\$ 20.68	\$ 18.84
5091	HT1000, MTS2000, MTX9000, MTX8004	HT1000, MTS2000, MTX8000, MTX9000	\$ 23.50	\$ 20.68	\$ 18.84
5092	HT1000, MTS2000, MTX9000, MTX8005	HT1000, MTS2000, MTX8000, MTX9000	\$ 23.50	\$ 20.68	\$ 18.84
5145	HT1250 & 750 Series w/9008A Batt & No Keypad	HT1200, 700	\$ 23.50	\$ 20.68	\$ 18.84
5146	HT1250 & 750 Series w/9008A Batt & Ltd Keypad	HT1200, 700	\$ 23.50	\$ 20.68	\$ 18.84
5147	HT1250 & 750 Series w/9008A Batt & Full Keypad	HT1200, 700	\$ 23.50	\$ 20.68	\$ 18.84

Visit us online at www.primuselectronics.com

2-WAY RADIO CASES—LEATHER

MOTOROLA RADIO CASES

Product #	Description	Model	Price 1-9	Price 10-24	Price 25+
5169	HT1250 & 750 Series w/ Ultra High Cap Batt & No Keypad	HT1200, 700	\$ 23.50	\$ 20.68	\$ 18.84
5170	HT1250 & 750 Series w/ Ultra High Cap Batt & Ltd Keypad	HT1200, 700	\$ 23.50	\$ 20.68	\$ 18.84
5171	HT1250 & 750 Series w/ Ultra High Cap Batt & Full Keypad	HT1200, 700	\$ 23.50	\$ 20.68	\$ 18.84
5172	HT1550 XLS w/ Ltd Keypad	HT1550	\$ 23.50	\$ 20.68	\$ 18.84
5173	HT1550 XLS w/ Full Keypad	HT1550	\$ 23.50	\$ 20.68	\$ 18.84
7091	MT1000 w/ Med Cap Batt	MT1000	\$ 23.50	\$ 20.68	\$ 18.84
7092	MT1000 w/ High Cap Batt	MT1000	\$ 23.50	\$ 20.68	\$ 18.84
5080	Radius P-110 w/ LG Batt	P-100	\$ 23.50	\$ 20.68	\$ 18.84
5081	Radius P-110 w/ SM Batt	P-100	\$ 23.50	\$ 20.68	\$ 18.84
5082	Radius P-110 w/ LG Batt & DTMF	P-100	\$ 23.50	\$ 20.68	\$ 18.84
5046	Radius P-100 w/ DTMF	P-100	\$ 23.50	\$ 20.68	\$ 18.84
5051	Radius P-100	P-100	\$ 23.50	\$ 20.68	\$ 18.84
7096	Radius P-1225 Stand Version	P-1225	\$ 23.50	\$ 20.68	\$ 18.84
7097	Radius P-1225 w/ Keypad	P-1225	\$ 23.50	\$ 20.68	\$ 18.84
7098	Radius P-1225 LS w/ Ltd Keypad & Std Batt	P-1225	\$ 23.50	\$ 20.68	\$ 18.84
5350	PR400 w/ No Keypad	PR400, PR1500	\$ 23.50	\$ 20.68	\$ 18.84
5351	PR400 w/ Ltd Keypad	PR400, PR1500	\$ 23.50	\$ 20.68	\$ 18.84
7082	HT600 w/ Med Cap Batt	Radius HT600, MTX800, MX800, MTX900, P-200	\$ 23.50	\$ 20.68	\$ 18.84
7083	HT600 w/ High Cap Batt	Radius HT600, MTX800, MX800, MTX900, P-200	\$ 23.50	\$ 20.68	\$ 18.84
5041	Radius P-200, MTX800 Series, MTX900 w/ High Cap Batt	Radius HT600, MTX800, MX800, MTX900, P-200	\$ 23.50	\$ 20.68	\$ 18.84
5042	Radius P-200, MTX800 Series, MTX900 w/ Med Cap Batt	Radius HT600, MTX800, MX800, MTX900, P-200	\$ 23.50	\$ 20.68	\$ 18.84
5667	Radius P-200, MTX800 Series, MTX900 w/ High Cap Batt	Radius HT600, MTX800, MX800, MTX900, P-200	\$ 23.50	\$ 20.68	\$ 18.84
5096	Visar w/ Med Batt	Visar	\$ 17.75	\$ 15.80	\$ 14.95
5097	Visar w/ High & Ultra High Cap Batt	Visar	\$ 17.75	\$ 15.80	\$ 14.95
5098	Visar w/ Med Batt & DTMF	Visar	\$ 17.25	\$ 15.85	\$ 14.95
5099	Visar w/ High & Ultra High Cap Batt & DTMF	Visar	\$ 17.25	\$ 15.85	\$ 14.95

AAR FREQUENCY ASSIGNMENT PLAN

CANADA ONLY

FAP	FREQUENCY	FAP	FREQUENCY	FAP	FREQUENCY	FAP	FREQUENCY
01	159.810	25	160.485	49	160.845	73	161.205
02	159.810	26	160.500	50	160.860	74	161.220
03	159.930	27	160.515	51	160.875	75	161.235
04	160.050	28	160.530	52	160.890	76	161.250
05	160.185	29	160.545	53	160.905	77	161.265
06	160.200	30	160.560	54	160.920	78	161.280
07	160.215	31	160.575	55	160.935	79	161.295
08	160.230	32	160.590	56	160.950	80	161.310
09	160.245	33	160.605	57	160.965	81	161.325
10	160.260	34	160.620	58	160.980	82	161.340
11	160.275	35	160.635	59	160.995	83	161.355
12	160.290	36	160.650	60	161.010	84	161.370
13	160.305	37	160.665	61	161.025	85	161.385
14	160.320	38	160.680	62	161.040	86	161.400
15	160.335	39	160.695	63	161.055	87	161.415
16	160.350	40	160.710	64	161.070	88	161.430
17	160.365	41	160.725	65	161.085	89	161.445
18	160.380	42	160.740	66	161.100	90	161.460
19	160.395	43	160.755	67	161.115	91	161.475
20	160.410	44	160.770	68	161.130	92	161.490
21	160.425	45	160.785	69	161.145	93	161.505
22	160.440	46	160.800	70	161.160	94	161.520
23	160.455	47	160.815	71	161.175	95	161.535
24	160.470	48	160.830	72	161.190	96	161.550
						97	161.565

Visit us online at www.primuselectronics.com



TERMS AND CONDITIONS

PRICE

Orders are shipped at the lower of the price prevailing at the time of the order or quoted prices. We may accept or reject any order at our sole discretion. Prices in our published price book/catalogs are subject to change without notice.

FREIGHT AND OTHER CHARGES

Freight charges are prepaid by us and added to your invoice. Unless you indicate a preference, we will ship "best way". Primus Electronics charges freight at Primus' cost. All shipments are insured at customers cost. Sales tax will be charged as required by law, unless shipment is for resale and a resale certificate is on file with Primus at the time of the order.

SHIPMENT

All shipments are F.O.B origin and title to the goods and risk of loss passes from us to you upon placement of goods with the carrier. Orders placed before 4:00 P.M. CST are usually shipped the same business day.

CREDIT AND PAYMENT TERMS

Prepayment or COD is generally required for new or non-rated accounts. Credit terms are given to rated accounts. Standard terms are net 30 days. Available credit line amounts are determined only by the Primus Electronics credit department and depend upon credit history, trade references and other business information we may require. We may accept Visa, MasterCard, Discover or American Express depending on your account history. A 1% late charge on all amounts over 60 days from date of the invoice will be added to your statement at the end of each month. Late payment history or persistently late payments may result in the account being placed with a collection service, immediate restriction to cash terms and reasonable cost of collection being added to amounts due. Invoices are rendered for all shipments. Statements are sent every month to open accounts to aid in customers' reconciliation of the amounts due.

WARRANTIES

Manufacturers' warranties are provided for all products we sell. You should process any warranty claims according to the manufacturers' instructions. WE MAKE NO WARRANTIES WHICH EXTEND BEYOND THE DESCRIPTION OF THE MATERIALS ORDERED. ALL OTHER WARRANTIES, EITHER EXPRESSED OR IMPLIED, INCLUDING BUT NOT LIMITED TO WARRANTIES AS TO MERCHANDISE OR FITNESS FOR A PARTICULAR PURPOSE, ARE HEREBY EXPRESSLY EXCLUDED.

RETURNS AND CLAIMS

Returns must be expressly authorized by us and are subject to a restocking fee of up to twenty percent (20%) of the purchase price. We will accept for return only new, non-defective, unused, in warranty and originally packaged products. All claims for unsatisfactory shipment of goods must be made directly to us within seventy two (72) hours of receipt of goods. If we do not accept or deliver your order, our only liability is to refund any amounts already paid to us. If you rightfully reject all or part of the goods before acceptance, then our only liability is, at our option, either (1) to permit you to return the goods and receive a refund of any amounts already paid to us or (2) the repair or replacement of nonconforming goods. UNDER NO CIRCUMSTANCES WILL WE BE LIABLE FOR INCIDENTAL OR CONSEQUENTIAL DAMAGES. DO NOT ACCEPT A VISIBLY DAMAGED PRODUCT WITHOUT NOTING THE DAMAGE ON THE BILL OF LADING.

APPLICATION

By placing an order with us you have agreed to these terms and conditions regarding that order and any subsequent orders. No modifications or other terms are binding on us without Primus' prior written approval. Illinois law applies to all transactions.

Toll-Free (800) 435-1636 • Fax (800) 767-7605

INDEX BY DESCRIPTION

Description	Page	Description	Page
1/2" Feeder Cable and Accessories	77	BackTalk Models	51
1/2" Flexible Cable and Accessories	76	BackTalk Suggested Antenna Options	51
1/2" Flexible Cable, Connectors and Accessories	74	Ballistic Nylon Pouches	88
1/2" Heliac Cable, Connectors and Accessories	75	Ballistic Nylon Pouches	88
1/4" Flexible Cable and Accessories	76	Base Station Antenna Harness	6
1/4" Flexible Cable and Connectors	74	Base Station Antennas	70-71
2-Way Radio Cases—Leather	89-92	Batteries	55
4" Boot Assembly Kits	81	Battery Chargers	61
4" Feed-Thru Assemblies	81	Battery Maintenance / Analyzer / Conditioner	52—53
5/8" Flexible Cable and Accessories	76	Belts and Ballistic Nylon Pouches	88
50 Ohm Braided Cable	75	Bent Copper Lugs	41
7/8" Feeder Cable and Accessories	77	Bond Strand	30
7/8" Heliac Cable and Connectors	74	Breakaway Safety Straps	87
800-900 MHz Base Station Antennas	70	Broadband HF/VHF/UHF Coaxial Protectors	67
800-960 MHz Antennas	71	Butt Splice Cable Connection Type	33
A		Butterfly Hangers	79
Accessories for Kenwood / Motorola Radio cases	90	C	
Adaptors	54	Cable and Accessories	74-81
Adjustable Nylon Belts	88	Cable Guards	30
AEI Reader Replacement Parts	6	Cable to Cable Ultraweld Connections	32-34
Aluminum Commercial PA Horns	83	Cable to Ground Rod Ultraweld Connections	35
Aluminum to Copper Ground Studs	31	Cable to Horizontal Steel Pipe	37-38
Angle Adapters	81	Cable to Lug or Bus Bar Ultraweld Connection	39
Antenna Mount with Cable	6	Cable to Steel Surface/Pipe Ultraweld Connections	37-39
ATCS Parts	6	Cable to Vertical Steel Pipe	38
Atlas Sound Horns and Speakers	84	Charger Extension and Replacement Cables	7
Axle Alternator Cable / Pulse Wabtec	6	Charger Plus Analyzer / Conditioner	53
B			
BackTalk Locomotive Radio Tester	51		

INDEX BY DESCRIPTION

Description	Page	Description	Page
Chestpacks and Speaker / Microphone Holder	86	Dribble Antennas	58
Coax Ground Kits	46	Dummy Receptacles	7
Coaxial Protectors	67	DVR Cable Assemblies	5
Communication Speakers	83	DVR Camera Options	5
Communications Applications	65	DVR Microphone Options	4
Communications Service Monitor	23	DVR Replacement Parts and Accessories	5
Communications Site Equipment	44–48	E	
Complete WatchDog Systems	4	End of Train Antennas	22
Compression Tool	28	ETD / HTD Bench Cables	11
Computer Wireless Accessories	7	ETD Batteries—Sealed Lead Acid	21
Conductance and Battery Testers	7	ETD Battery Cable	8
Converters / Power Systems / Battery Chargers	61	ETD Battery Charger Replacement Cables	8
Copper Clad Steel Ground Rods	42	ETD Battery Charger—NiCAD	21
Copper Lugs	40-41	ETD Battery Chargers	8
Cushion Hanger Assemblies	79	ETD Battery Pack Replacement Electronics	9
D		ETD Battery Pack Replacement Electronics Modules	8
DC-DC Converter	5	ETD Battery Pack Replacement Parts	9
DC-DC Converters / Isolated / Spike Protected	61	ETD Parts	9
DC-DC Power Converters: Isolated Rackmount	63	ETD RF Cables	10
DC-DC Power Converters: Isolated Wall Mount	62	ETD Wiring Harness	10
DC-DC Power Converters: Non-Isolated	62	Excalibur Series Locomotive Antennas	68-69
Defect Detector Interface Cables	7	Expandable Leather Belts	88
Desktop	64	F	
Desktop LP Series	66	Feedthrough Stud	31
Desktop Switching Power Supply	62	Field Made Tab Style Bonds	29
Digital Video Recording Systems	4-5	Flanger	50
Double Stainless Steel Coax Hangers	48	Fully Isolated 72-12 Converters	65
DPS Series Stand Alone or Rackmount	66	G	
		Galvanized Steel Ground Rods	42

INDEX BY DESCRIPTION

Description	Page	Description	Page
Ground Rod to Cable Over Top Connection Type	35	In-Line Twisted Pair Protectors	67
Ground Rod to Dead End Cable Connection Type	35	IQ Five Analyzer / Conditioner	53
Grounding and Bonding	42–43	IQ Pac Personal Analyzer Charger	52
Guy Wire Clamps	45	IQ Plus Analyzer / Conditioner	52
H		IQ Plus ETD Battery Maintenance	52
Halo Standoff Clamps	44	J	
Handset Adapter Cables	12	Joint Head Bonds 3/16”	24
Harger Railroad Products	24-48	Joint Head Bonds 5/16”	25
Hoisting Grips	79	Jumper Bootleg and Switch Bonds	28
Horizontal Butt Down On Surface Connection	37	K	
Horizontal Butt Down Pipe Connection Type	37	Kenwood Adaptors	54
Horizontal Butt Off Pipe Connection Type	37	Kenwood Radio Cables	15
Horizontal Butt Off Surface Connection Type	37	Kenwood Radio Cases	89-90
HTD / ETD Bench Cables	14	Kenwood Radio Replacement Batteries	56
HTD / ETD Parts	12	Kenwood Replacement Batteries	57
HTD / ETD Replacement Parts	15	Kenwood TK Portable Replacement Antennas	58
HTD / ETD RF Cables	15	L	
HTD / ETD Test Equipment	15	LAN RF Cable	15
HTD Adapter Cables	12	Land Mobile Antennas	72-73
HTD Cables	12	Land Mobile Antennas—Antenna Specialists	72
HTD Parts	12	Land Mobile Antennas—Maxrad	72
HTD Power Cables	13	Land Mobile Antennas—Radiall Larsen	73
HTD Power Cables / Pulse Wabtec	13	Lantern Battery (Rechargeable)	21
HTD RF Cables	13	Linear DC Power Supplies	64
HTD Specialized Adapter Cables	13	LMR Cable and Connectors	78
I		LOBO Trading ETD Parts	21
Inflatable Lighting	23	Locomotive Antenna Footprint	69
		Locomotive Antennas	15, 68

INDEX BY DESCRIPTION

Description	Page	Description	Page
Locomotive Cables	16	Mounting Hardware and Accessories	71
Locomotive Parts	16	MSOA Vehicle Laptop Mounting Systems	49
Locomotive Radio Parts	16	MX Series Portable Replacement Antennas	58
Locomotive Radio Power Cables	16	N	
Locomotive Radio Replacement Parts	16	NGEN ATX / Wabtec Specialized Items	20
Locomotive Radio RF Cables	17	P	
Locomotive Remote Control Replace Batteries	57	Parallel Butt Connection Type	32
Locomotive Remote Control Vest	87	Parallel Splice Connection Type	33
Low Profile Power Supplies	61	Parallel Thru Cable Connection Type	33
LP Accessories and Custom Hoods	66	Pipe Mount Air Terminal Kits	45
Lug End Connection Type	39	Pipe to Pipe Clamps	70
M		Portable Replacement Antennas	58
MCP Cables (Wabtec)	17	Power Line Extension Protectors	67
Memorylink Wireless Equipment	50	Power Supplies	62-67
Microphone Covers	84	Power Systems	61
Microphones and Accessories	83	R	
Misc. Adaptors	54	Rackmount	64
Mobile Antennas	22	Radio Chestpack	86
Mobile PA Amplifiers	84	Radio Manufacturer Cross Reference	59
Motorola Adaptors	54	Radio Safety Vest	87
Motorola Aftermarket Products	60	Rail Head Double Welder Components	26
Motorola Branded Batteries	55	Rail Head Double Welders 3/16"	25
Motorola Branded Chargers	60	Rail Head Double Welders 5/16"	26
Motorola Misc. Aftermarket Products	60	Rail Head Single Welders	27
Motorola Radio Cases	91-92	Railroad Handset Replacement Parts	85
Motorola Radio Replacement Batteries	56	Railroad Products	6-20
Motorola Replacement Batteries	57	Rear End Marker Batteries	21
Motorola Speaker Microphones	60	Repair Adapter and Test Cables	17

INDEX BY DESCRIPTION

Description	Page	Description	Page
Replacement Batteries	56–57	Tower Standoff for Snap-ins with Hose Clamp	47
RF Bench Cables	17	Tower Standoff with Hose Clamp	47
Round Member Adapters	80	Track Circuit Connectors (Web)	27
RS Series	61	U	
Run and Tap Connection Type	34	UHF Antennas	71
S		UHF Base Station Antennas	70
Safety Vests and Breakaway Straps	87	Ultraweld Connections	32–39
Sectional Stainless Steel Ground Rods	43	Uni-Shots Ultraweld Connections	36
Servo Head Control Cables	18	Universal Ground Kit	46
Servo Hot Box Cables	18	Universal Snap-In Hangers	79
SF Series Portable Replacement Antennas	58	V	
Shock-Proof Plastic Weatherproof PA Horns	83	VDC Converters	61
Signal Bonds (Welded)	24-30	Vertex Radio Replacement Batteries	56
Signal Hut Grounding	31	Vertical Angle Connection Type	38
Single Stainless Steel Coax Hangers	47	Vertical Angle Pipe Connection Type	38
Speaker / Microphone Holder	86	Vertical Down Connection Type	38
Stainless Steel Clip	44	Vertical Down Pipe Connection Type	38
Stainless Steel Down Conductor Angle Adapter	48	Vertical Surface Horizontal Cable Connection	39
Stainless Steel Down Conductor Standoff	48	Vertical Thru on Vertical Surface Connection	39
Stainless Steel Ground Rods	43	VHF Antennas	71
Stand-off Adapters	80	VHF Base Station Antennas	70
Stand-off Bracket for Wood Pole Mounting	71	VHF Radio Antennas	69
Stand-off Brackets	71	VLCC Specialized Cables	19
Steel Signal Case Ground Plates	31	W	
Straight and Offset Copper Lugs	40	WatchDog DVR	4
Strongbow	50	Weather Proofing Kits	45
T		Web bond Welders and Molds	29
Tool Bags and Accessories	82	Y	
Tower Air Terminals	44	Yaesu Radio Replacement Batteries	56



INDEX BY PRODUCT NO.

Description	Page	Description	Page	Description	Page	Description	Page
1	84	5096	92	7092	92	7236	89
3	84	5097	92	7096	92	7237	89
5	70	5098	92	7097	92	7240	89
100	88	5099	92	7098	92	7250	90
110	42	5101	91	7113	89	7251	90
111	70	5102	91	7114	89	7252	90
345	90	5104	91	7115	89	7253	90
348	42	5107	91	7116	89	7254	89
350	90	5110	91	7117	89	7255	89
360	90	5145	91	7118	89	7256	89
375	90	5146	91	7119	89	43094	75
588	42	5147	91	7120	89	252107	79
1016	85	5169	92	7124	90	252109	79
1210	42	5170	92	7128	90	252113	79
2362	86	5171	92	7129	90	252115	79
3410	42	5172	92	7130	90	252119	79
5012	91	5173	92	7132	90	252121	79
5013	91	5196	91	7138	90	252130	81
5041	92	5197	91	7142	89	252135	81
5042	92	5350	92	7143	89	252136	81
5046	92	5351	92	7147	90	252137	81
5051	92	5667	92	7211	89	252146	81
5076	91	5810	42	7212	89	252147	81
5077	91	7051	89	7214	90	252150	81
5078	91	7053	89	7218	90	252151	81
5079	91	7054	89	7219	90	294555	80
5080	92	7061	89	7220	89	294556	80
5081	92	7064	89	7223	90	294557	80
5082	92	7065	89	7224	90	294558	80
5085	91	7073	89	7226	90	294559	80
5086	91	7078	91	7227	90	294560	80
5087	91	7082	92	7232	90	294561	80
5088	91	7083	92	7233	90	294562	80
5091	91	7086	91	7234	89	294571	81
5092	91	7091	92	7235	89	294573	81

INDEX BY PRODUCT NO.

Description	Page	Description	Page	Description	Page	Description	Page
294650	79	30848-5	80	741PB	85	AMN-9008N	56
294651	79	321B	30	741PBTS	85	AP-152.3	72
294652	79	321G	30	741RE3	85	APR-153	72
294653	79	3410G	42	741SA	85	ASCACGS6SX36	31
294655	79	3410SS3	43	74HO1	85	ASCACGS6SX48	31
294656	79	348G	42	74R01	85	ASCACGS6SX60	31
294657	79	36-12-18ISP	61	74T01	85	ASCACGS6SX72	31
294685	81	36-12-6ISP	61	97-50-150-15	9	ASCFS72	31
294687	81	41SP	74	A1211A-152	69	ASP 705K	71
294698	81	43211A	75	A1511A-161	69	ASP-7455	72
294700	81	48-12-12I	61	A1511B-161	69	ASP-7655	72
+CIRDUM/1	7	48-12-6I	61	AAHMN9052A	60	ASPB 685	71
100-Y	88	5/16CBWB	30	AAHTN3000	60	ASPC-20	83
113A	70	5/16TCBWB	30	AES-4	83	AY-FNB57	56
1210SS3	43	5023V	21	AK-KNB12	56	AY-FNB57N	56
12-12-12I	61	5079S	21	AK-KNB12N	56	B132S	69
125U	70	5079V	21	AK-KNB15	56	BA1018	54
2362BA-RS/B	86	5519V	21	AK-KNB15-15	56	BA1022	54
2362BA-RS/B-IM	86	5608V	21	AK-KNB17	56	BA1061	54
2362BA-RS/O	86	5761V	21	AM-4496	56	BA1098	54
2362BA-RS/O-IM	86	5788V	21	AM-4497Li	56	BA1105	54
2362RS/B	86	5810G	42	AM-4851	56	BA1122	54
2362RS/B-IM	86	5810SS3	43	AM-5414	56	BA1142	54
2362RS/O	86	585CCat	44	AM-5447	56	BA1153	54
2362RS/O-IM	86	585CCAT-2/o	44	AM-7143	56	BA1155	54
241088-1	75	588G	42	AM-7144	56	BA1179	54
2412-40	61	588SS3	43	AM-7144N-27	56, 57	BA1183	54
2-UWM150	33	5911V	21	AM-8148	56	BA1198	54
2-UWM200	33	6468V	21	AM-9008N	56	BA4011	54
3/16CBWB	30	6587V	21	AM-9018	56	BA4014	54
3/16TCBWB	30	72-12-18ISP	61	AM-9027	56	BC3501QC	52
30848-1	80	72-12-6ISP	5, 61	AM-9044	56	BC3503PC	53
30848-2	80	741CP	85	AM-9049-15	56	BC3503QC	52
30848-3	80	741CS	85	AM-9360	56	BC3506PC	53
30848-4	80	741FG	85	AM-9628	56	BC3506QP-5	53

INDEX BY PRODUCT NO.

Description	Page	Description	Page	Description	Page	Description	Page
BC3603QC	52	BSLV3/16X1	29	CC5	44	EMS94	85
BC3603QC-EOT	21, 52	BSLV3/16X1.5	29	CGKBB1/2-5	46	EXB-155-MX	58
BCIQPAC	52	BSLV5/16X1	29	CGKBB1-1/4-5	46	EXB-155-SF	58
BCLIP3/16	25	BSLV6X1	29	CGKBB1-5/8-5	46	EXH-160-MX	58
BCLIP5/16	26	BU1	85	CGKBB2-1/4-5	46	EXH-160-SF	58
BCLIP5/16	26	BXL-141	41	CGKBB3/8-5	46	EXH-160-SFK	58
BM-NC	72	BXL-141.5	41	CGKBB5/8-5	46	EXH-160-SFU	58
BMPL	72	BXL-141.52B	41	CGKBB7/8-5	46	EXS-155-MX	58
BNSF6KS-002	19	BXL-141.52C	41	COM3010	23	EZ-240-NM	78
BP200	88	BXL-141.52D	41	CORD-16'	85	EZ-400-NMH	78
BP3010	23	BXL-1412B	41	CPT-BK	74	EZ-400-NMH-RA	78
BP400	88	BXL-1412C	41	CPT-BKS1	75	EZ-400-UM	78
BP500	88	BXL-1412D	41	CPT-F4	74	EZ-600-NMC-2	78
BP600	88	BXL-181	41	CPT-L4ARC1	75	EZ-900-NFC-2	78
BP600R	88	BXL-1812B	41	CT-240/200/100	78	EZ-900-NMC-2	78
BP800	88	BXL-1812C	41	CT-400/300	78	F1MU	74
BS-1/0B	33	BXL-1812D	41	DB222-B	71	F1PBM-C	74
BS150U-161	51	BXL-3161	41	DB224-B	71	F1PNM-HC	74
BS-1L	33	BXL-31612B	41	DB264-B	71	F1PNMV2-H	74
BS-1MMC	33	BXL-31612C	41	DB365-OS	71	F1PNR-HC	74
BS-2/0B	33	BXL-31612D	41	DB365-SP5	71	F4PNMV2-HC	74
BS-25CMB	33	BXL-381.5	41	DB365W	71	F4PNR-HC	74
BS-2L	33	BXL-381.52B	41	DB5001	71	FL4001A	50
BS-3/0B	33	BXL-381.52C	41	DB5007	71	FL4002A	50
BS-3/16L	33	BXL-381.52D	41	DB580-Y	71	FL4003A	50
BS-35CMB	33	BXL-382	41	DB583-Y	71	FL4004A	50
BS-3CMB	33	BXL-3822B	41	DPS-15	66	FSJ1-50A	74
BS-3L	33	BXL-3822C	41	DPS-30	66	FSJ1-50A-RP	74
BS-4/0B	33	BXL-3822D	41	DPS-45	66	FSJ4-50B	74
BS-4L	33	CBS-100	83	DPS-55	66	FSJ4-50B-RP	74
BS-5CMB	33	CBS-200	83	DPS-75	66	G	72
BS-6L	33	CBS-240	83	DR01V	85	G11-341/0	36
BS-6SL	33	CBS-240W	83	DR-150-MX	58	G11-342	36
BS-75CMC	33	CBS-4	83	DR-150-SF	58	G11-342/0	36
BSLV3/16X.75	29	CC3010	23	DR-155-BN	58	G11-344	36

INDEX BY PRODUCT NO.

Description	Page	Description	Page	Description	Page	Description	Page
G11-348	36	GD-342B	35	GO-582B	35	HNN9049A	55
G11-581/0	36	GD-342SB	35	GO-582SB	35	HNN9360B	55
G11-582	36	GD-344/0B	35	GO-584-0/B	35	HNN9628B	55
G11-582/0	36	GD-344L	35	GO-584L	35	HSC100	44
G11-584	36	GD-346L	35	GO-586L	35	HSC100C	44
G11-588	36	GD-581/0B	35	GPL	72	HSC150	44
G21-341/0	36	GD-582/0B	35	GPSNMO02	73	HSC150C	44
G21-342	36	GD-5825CMB	35	HB-2/0**B	37	HTN9042	60
G21-344	36	GD-582B	35	HB-2/0B	37	ICT12012-10A	62
G21-348	36	GD-582SB	35	HB-25CM**B	37	ICT12012-11A	62
G21-581/0	36	GD-584-0/B	35	HB-25CMB	37	ICT12012-12A	62
G21-582	36	GD-584L	35	HB-2B	37	ICT12012-15A	62
G21-584	36	GD-586L	35	HB-2SB	37	ICT12012-20A	62
G21-588	36	GK-S400T	78	HB-3/0**B	37	ICT12012-30A	62
G31-341/0	36	GK-S600T	78	HB-4/0**B	37	ICT12012-4A	62
G31-342	36	GK-S900T	78	HB-4/0B	37	ICT12012-6A	62
G31-344	36	GO-102/0B	35	HD-1**A	37	ICT2060-12AIR	63
G31-348	36	GO-1025CMB	35	HD-2**A	37	ICT2060-12AIW	62
G31-581/0	36	GO-104/0B	35	HD-2/0B	37	ICT2060-20AIR	63
G31-582	36	GO-122/0B	35	HD-2A	37	ICT2060-20AIW	62
G31-584	36	GO-122B	35	HD-2SA	37	ICT206024-10AIR	63
G31-588	36	GO-124/0B	35	HD-4**A	37	ICT206024-10AIW	63
GA-15T	84	GO-124L	35	HD-4A	37	ICT206024-5AIR	63
GA-30T	84	GO-126L	35	HD-6**A	37	ICT206024-5AIW	63
GD-102/0B	35	GO-341/0B	35	HD-6A	37	ICT2412-10A	62
GD-1025CMB	35	GO-342/0B	35	HD-6SA	37	ICT2412-15A	62
GD-104/0B	35	GO-3425CMB	35	HMDIE3/16	29	ICT2412-2.5A	62
GD-122/0B	35	GO-342B	35	HMDIE5/16	29	ICT2412-20A	62
GD-122B	35	GO-342SB	35	HMN9030A	60	ICT2412-30A	62
GD-124/0B	35	GO-344/0B	35	HMN9031A	60	ICT2412-40A	62
GD-124L	35	GO-344M	35	HNN8148B	55	ICT2412-5A	62
GD-126L	35	GO-346M	35	HNN9008AR	55	ICT50100-12AIR	63
GD-341/0B	35	GO-581/0B	35	HNN9009AR	55	ICT50100-12AIW	62
GD-342/0B	35	GO-582/0B	35	HNN9018AR	55	ICT50100-20AIR	63
GD-3425CMB	35	GO-5825CMB	35	HNN9044AR	55	ICT50100-20AIW	62

INDEX BY PRODUCT NO.

Description	Page	Description	Page	Description	Page	Description	Page
ICT5010024-10AIR	63	LE-2/0181B	39	LPH-MOT/L	66	MKNB-14	57
ICT5010024-10AIW	63	LE-2181B	39	LPH-MOT/S	66	MKNB-15	57
ICT5010024-5AIR	63	LE-25CM141.5B	39	LPH-MOT-CDM	66	MKNB-17	57
ICT5010024-5AIW	63	LE-25CM141B	39	LPH-MOTIDEN	66	MLB4000	72
IPS 12-40	61	LE-3CM141.5B	39	LRC-VEST-2X	87	MLPVDB800/1900	72
IPS 24-22	61	LE-3CM141B	39	LRC-VEST-3X	87	MO-2	84
IPS 48-11	61	LE-4/0141.5B	39	LRC-VEST-M/L	87	MT-C8743	71
IQ-4	66	LE-4/0141B	39	LRC-VEST-S	87	MUF4500	72
IS-3T1	67	LE-4/03161B	39	LRC-VEST-XL	87	MWB1320	69
IS-50NX-Co	67	LE-4181B	39	M5414	57	N100	88
IS-50NX-C1	67	LE-5CM141.5B	39	M5414B	57	N100Y	88
IS-50NX-C2	67	LE-5CM142B	39	M5447	57	N2412-12	61
IS-50UX-Co	67	LE-5CM381.5B	39	M5447B	57	N2412-24	61
IS-50UX-C1	67	LE-5CM382C	39	M5521	57	NA4013H	57
IS-B50LN-Co	67	LE-6181B	39	M5521B	57	NKA1001	77
IS-B50LN-C1	67	LE-75CM142C	39	M7143	57	NKA1003	77
IS-B50LN-C2	67	LE-75CM381.5C	39	M7144	57	NKA1007	76
IS-DPTL	67	LE-75CM382C	39	M7144HX	57	NKA1009	76
IS-SPTL	67	LMR-240	78	M8148	57	NKA12012	77
IS-T1	67	LMR-240-DB	78	M9009	57	NKA12058	76
K-794	72	LMR-400	78	M9009-H	57	NKA12078	77
L4PNF-RC	75	LMR-400-DB	78	M9009-HX	57	NKA22012	76
L4PNM-RC	75	LMR-600	78	M9049	57	NKC1012100	77
L4SGRIP	75	LMR-600-DB	78	M9360	57	NKC1012200	77
L5PNF-RPC	74	LMR-900-DB	78	M9628	57	NKC1012300	77
L5PNM-RPC	74	LP-10	66	MATH	72	NKC1012400	77
L5TNF-PS	74	LP-14	66	MCPT-1412	74	NKC1012500	77
LC-R121R3PU	21	LP-18	66	MCPT-BK4	75	NKC1012600	77
LCR12V17CP	21	LP-25	66	MCPT-L4	75	NKC1058300	76
LCR12V3.4P	21	LPBC-25	66	MCT81/0	28	NKC1058400	76
LDF4-50A	75	LPH-BENKING	66	MGS-1	83	NKC1078100	77
LDF5-50A	74	LPH-ICOM 221S	66	MHB1520	69, 72	NKC1078200	77
LE-1MM122C	39	LPH-KEN/L	66	MHB5800	72	NKC1078300	77
LE-1MM382C	39	LPH-KEN/S	66	MHB5802	72	NKC1078400	77
LE-2/0141B	39	LPH-MAX/GE	66	MHB5802S	72	NKC2012120	76

INDEX BY PRODUCT NO.

Description	Page	Description	Page	Description	Page	Description	Page
NKC2012220	76	NTN1168	60	OXL-3822B	40	PB-26SB	32
NKC2012320	76	NTN4633	60	OXL-3822C	40	PB-28SB	32
NKC2012420	76	NTN4849A	60	OXL-3822D	40	PB-2S2SB	32
NKC2012520	76	NTN4864	60	P-005	16	PB-3/163/16B	32
NKC2012620	76	NTN5414BR	55	P-005RA	16	PB-3/166SB	32
NKC2014120	76	NTN5447BR	55	P-006	13	PB-44B	32
NKC2014220	76	NTN5538	60	P-007	13	PB-46B	32
NKC2014320	76	NTN7143CR	55	P-007RA	13	PB-46SB	32
NKC2014420	76	NTN7144CR	55	P-007RA/240	13	PB-48SB	32
NKC2014620	76	OXL-141	40	P-007RA/78	13	PB-6S3/16B	32
NKRF01200	77	OXL-141.5	40	P-015RA	16	PB-6S5/16B	32
NKRF05800	76	OXL-141.52B	40	P-019	7	PB-6S6SB	32
NKRF07800	77	OXL-141.52C	40	P-11202-10FT	7	PIL 1000	23
NKRFF01200	76	OXL-141.52D	40	P-11202-3FT	7	PLDO-120US15A	67
NKRFF01400	76	OXL-1412B	40	P-11202R-10FT	7	PLDO-120US20A	67
NMN6156B	60	OXL-1412C	40	P-11202R-3FT	7	PMATKT2.5/32T	45
NMN6193A	60	OXL-1412D	40	P-13MQSQ	10	PMATKT3.5/42/0T	45
NMO150B	73	OXL-1422B	40	P-6MMSQ	10	PMUA-4252	22
NMO150BCO	73	OXL-1422C	40	PA1022	54	PRIMUS150/AC	51
NMO150BK	73	OXL-1422D	40	PA1055	54	PRIMUS150/AC-70	51
NMO150CK	73	OXL-181	40	PA1122	54	PRIMUS150/DC	51
NMO40C	73	OXL-1812B	40	PA1153	54	PRIMUS150/DC-70	51
NMOKUD	73	OXL-1812C	40	PA1155	54	PRIMUS16	69
NMOMMR	73	OXL-1812C3/8	40	PA1183	54	PRIMUS2IL-008	12
NMOMMRPL	73	OXL-1812D	40	PA1198	54	PRIMUS2IL-044	12
NMOQW	69	OXL-3161	40	PA4011	54	PRIMUS500	49
NMOWBQC	69	OXL-31612B	40	PA4014	54	PRIMUS551	49
NNTN4075-R	60	OXL-31612C	40	PA4543	54	PRIMUS552	49
NNTN4496AR	55	OXL-31612C3/8	40	PA4545	54	PRIMUS553	49
NNTN4497BR	55	OXL-31612D	40	PAT-20TB	84	PRIMUS554	49
NNTN4851A	55	OXL-381.5	40	PAT-30	84	PRIMUS555	49
NNTN4970AR	55	OXL-381.52B	40	PAT-60	84	PRIMUS556	49
NP5/10	85	OXL-381.52C	40	PB-22B	32	PRIMUS-MHP	86
NP510ST	85	OXL-381.52D	40	PB-24B	32	PS-3/163/16L	33
NP510STC	85	OXL-382	40	PB-26B	32	PS-66L	33

INDEX BY PRODUCT NO.

Description	Page	Description	Page	Description	Page	Description	Page
PS-6S6SL	33	PT-46B	33	RBJHTS3/167.5KT	24	RBTC3/164	27
PS-88L	33	PT-46SB	33	RBJHTS3/169.75	24	RBTC3/164KT	27
PS-8S8SL	33	PT-48B	33	RBJHTS3/169.75KT	24	RCMR-15	84
PT-2/01/0B	33	PT-48SB	33	RBJHTS5/167	25	RFB1142-4	58
PT-2/01B	33	PT-66B	33	RBJHTS5/167KT	25	RFU-501	68
PT-2/02/0B	33	PT-6S3/16B	33	RBJHTS5/169.75	25	RFU-531	68
PT-2/02B	33	PT-6S6SB	33	RBJHTS5/169.75KT	25	RFU-603	13
PT-2/04B	33	PT-7	61	RBJHXS3/166.5	24	RG8	68
PT-2/06B	33	PT-70A	61	RBJHXS3/166.5KT	24	RM-A800	80
PT-2/06SB	33	QW152	69	RBJHXS3/167.5	24	RMJH6.5T6FRM	25
PT-2/08B	33	RB1	85	RBJHXS3/167.5KT	24	RMJH7.5T6FRM	25
PT-2/08SB	33	RBBLTS.75-3/16"L	28	RBJHXS3/169.75	24	RMJH7T6FRM	26
PT-22B	33	RBBLTS.75-3/16KT"L"	28	RBJHXS3/169.75KT	24	RMJH9.75T6FRM	25, 26
PT-24-40	61	RBBLTS1.5-3/16"L"	28	RBJPTS.75-3/16"L"	28	RMJHFR3/166.5T6	25
PT-24-8	61	RBBLTS1.5-3/16KT"L"	28	RBJPTS.75-3/16KT"L"	28	RMJHFR3/167.5T6	25
PT-24B	33	RBBLTS1-3/16"L"	28	RBJPTS1.5-3/16"L"	28	RMJHFR3/169.75T6	25
PT-26B	33	RBBLTS1-3/16KT"L"	28	RBJPTS1.5-3/16KT"L"	28	RMJHFR3/16T7	27
PT-26SB	33	RBBLTS1-5/16"L"	28	RBJPTS1-3/16"L"	28	RMJHFR3/16X	24, 25, 27
PT-28B	33	RBBLTS1-5/16KT"L"	28	RBJPTS1-3/16KT"L"	28	RMJHFR5/16T6	26
PT-28SB	33	RBBLXS3/16"L"	28	RBJPTS1-5/16"L"	28	RMJHFR5/169.75T6	26
PT-2S2SB	33	RBBLXS3/16KT"L"	28	RBJPTS1-5/16KT"L"	28	RMJHFR5/16T7	27
PT-3/163/16B	33	RBG	72	RBJPXS3/16"L"	28	RMJHFR5/16X	25, 26, 27
PT-3/166SB	33	RBJHFR3/166.5	24	RBJPXS3/16KT"L"	28	RMJHFRE/16X	25
PT-4/01/0B	33	RBJHFR3/166.5KT	24	RBSWTS.75-3/16"L"	28	RMJHT6EB6.5	26
PT-4/01B	33	RBJHFR3/167.5	24	RBSWTS.75-3/16KT"L"	28	RMJHT6EB7	26
PT-4/02/0B	33	RBJHFR3/167.5KT	24	RBSWTS1.5-3/16"L"	28	RMJHT6EB7.5	26
PT-4/02B	33	RBJHFR3/169.75	24	RBSWTS1.5-3/16KT"L"	28	RMJHT6EB9.75	26
PT-4/03/0B	33	RBJHFR3/169.75KT	24	RBSWTS1-3/16"L"	28	RMJHT6FNEB	26
PT-4/04/0B	33	RBJHFR5/167	25	RBSWTS1-3/16KT"L"	28	RMJHT6MMKT	26
PT-4/04B	33	RBJHFR5/167KT	25	RBSWTS1-5/16"L"	28	RMJHT7FRM	27
PT-4/06B	33	RBJHFR5/169.75	25	RBSWTS1-5/16KT"L"	28	RMJHTS1-3/16T7	27
PT-4/06SB	33	RBJHFR5/169.75KT	25	RBSWXS3/16"L"	28	RMJHTS1-3/16X	27
PT-4/08B	33	RBJHTS3/166.5	24	RBSWXS3/16KT"L"	28	RMJHTS3/166.5T6	25
PT-4/08SB	33	RBJHTS3/1665.KT	24	RBTC3/1612	27	RMJHTS3/167.5T6	25
PT-44B	33	RBJHTS3/167.5	24	RBTC3/1612KT	27	RMJHTS3/169.75T6	25

INDEX BY PRODUCT NO.

Description	Page	Description	Page	Description	Page	Description	Page
RMJHTS3/16T7	27	RR-006.1	10	RR-056/017X085	18	RR-088B-3.10	11, 14
RMJHTS3/16X	24, 25, 27	RR-007	10	RR-056/017X100	18	RR-088B-4.10	11, 14
RMJHTS5/16T6	26	RR-008	11	RR-057	19	RR-089	15
RMJHTS5/169.75T6	26	RR-008	14	RR-058	19	RR-090/015X116	19
RMJHTS5/16T7	27	RR-009	11, 14	RR-059	19	RR-091	7
RMJHTS5/16X	25, 26, 27	RR-010	10	RR-060	19	RR-091/010	7
RMJHXS3/166.5T6	25	RR-012	18	RR-061	19	RR-092	15
RMJHXS3/167.5T6	25	RR-013	12	RR-062	16	RR-092/72	15
RMJHXS3/169.75T6	25	RR-031	13	RR-063/015X016.5	18	RR-093/010	7
RMJHXS3/16T7	27	RR-033	10	RR-063/053X065	18	RR-094/078	13
RMJHXS3/16X	24, 25, 27	RR-033.1	10	RR-063/057X065	18	RR-094/102	13
RMWS3/16T21	29	RR-034	13	RR-063/063X065	18	RR-095CA/078	6
RMWT21FRM	29	RR-035	11, 14	RR-064	16	RR-095CA/102	6
RMWTS.75-3/16T21	29	RR-036	11, 14	RR-067	6	RR-095CA-20PPR/102	6
RMWTS.75-3/16X	29	RR-037	13	RR-069	12	RR-095MS/078	6
RMWTS1.5-3/16T21	29	RR-039	16	RR-070	16	RR-097	7
RMWTS1.5-3/16X	29	RR-040	10	RR-071	12	RR-098R/078	6
RMWTS1-3/16T21	29	RR-041	11, 14	RR-072	9	RR-098S/078	6
RMWTS1-3/16X	29	RR-043	7, 16	RR-073	9	RR-099/010	19
RMWTS1-5/16T21	29	RR-044	7, 16	RR-074	12	RR-100/068	19
RMWTS1-5/16X	29	RR-045	11, 14	RR-075	8	RR-100/100	19
RMWXS3/16X	29	RR-047	9	RR-076	8	RR-101/100	19
RPS-1203	64	RR-047.1	9	RR-077	11, 14	RR-102	7
RPS-1203UL	64	RR-048	12	RR-079	15	RR-103	17
RPS-1204CPBT	64	RR-049	12	RR-080	11, 14, 20	RR-104	17
RPS-1207	64	RR-050	18	RR-081	17	RR-105/14	13
RPS-1210UL	64	RR-051	11, 14	RR-082	17	RR-105/36	13
RPS-1220	64	RR-052	9	RR-083	19	RR-105/48	13
RPX4747	60	RR-055/015X116	18	RR-084	19	RR-107	15, 20
RR-003	13	RR-055/017X065	18	RR-085	15	RR-108	11, 14, 20
RR-004	12	RR-055/017X085	18	RR-086	15	RR-109	16
RR-004.1	12	RR-055/017X100	18	RR-087/0240	17	RR-110	11, 14, 20
RR-004.2	12	RR-055/053X065	18	RR-087/0300	17	RR-112	15
RR-005	10	RR-055/057X065	18	RR-088A-1.825	11, 14	RR-113	10
RR-006	10	RR-056/017X065	18	RR-088A-3.125	11, 14	RR-115	11, 14



INDEX BY PRODUCT NO.

Description	Page	Description	Page	Description	Page	Description	Page
RR-117	13	RR-148	15	RR-5222/*	5	RRP-211	9
RR-118	60	RR-149	11, 14	RR-5222C/*x*	5	RRP-216	7
RR-118A	60	RR-153	16	RR-5225	5	RRP-217	7
RR-119	11, 14	RR-154	13	RR-5227	5	RRP-218	7
RR-120	17	RR-155	17	RR-5310	5	RRP-219	7
RR-121	15	RR-156	17	RR-5312/*	5	RRP-225	9
RR-122	17	RR-157	17	RR-5325	5	RRP-226	9
RR-123/018RA	17	RR-158	17	RR-5450	5	RRP-240	10, 15
RR-123/036	17	RR-160/160MHZ	6	RR-5500	5	RRP-330	8, 20
RR-123/036RA	20	RR-160/450MHZ	6	RR-5600	4	RRP-330.1/36	8
RR-123/36RA	17	RR-161/100	12	RR-5700	5	RRP-330.1/72	8
RR-124/36	17	RR-164	12	RR-5700H	5	RRP-330.2/72	8
RR-124/48	17	RR-165	16	RR-5701	5	RRP-330.3/36	8
RR-125/36	17	RR-167	6	RR-5702	5	RRP-331	8
RR-126	16	RR-168	13	RR-5705	5	RRP-332	8
RR-127	11, 14	RR-169	16	RRD-001	11, 14	RRP-334	8
RR-128	11, 14	RR-173	12	RRD-002	11, 14	RRP-336	8
RR-129	11, 14	RR-174	16	RRD-1001	11, 14	RRP-336.1/120	8
RR-130	11, 14	RR-175	16	RRP-089	10	RRP-338	8
RR-131	16	RR-176	6	RRP-201	8	RS-10A	61
RR-131SR	16	RR-176NPC	6	RRP-201BN	8	RS-12A	61
RR-132	16	RR-176PC	6	RRP-201NS	8	RS-20A	61
RR-133/012	17	RR-177	6	RRP-202	8	RS-35A	61
RR-133/013	17	RR-178	60	RRP-203	9	RS-3A	61
RR-134	19	RR-179/030	6	RRP-204	9	RS-4A	61
RR-135	12	RR-184/012	7	RRP-205	9	RS-50A	61
RR-136/036	17	RR-185	20	RRP-205BN	9	RS-5A	61
RR-137	15, 20	RR-186	10	RRP-205UP	9	RS-70A	61
RR-138	15, 20	RR-5000HDD/160	5	RRP-205WC	9	RS-7A	61
RR-141/036	17	RR-5000HDD/250	5	RRP-206	9	RSVL-BA	87
RR-142/1440	19	RR-5000HDD/400	5	RRP-206BN	9	RSVS-BA	87
RR-145	12	RR-5204/160	4	RRP-207	9	RSVX-BA	87
RR-147	15	RR-5204/160/P1	4	RRP-208	9	RT-1/01/0B	34
RR-147/004	20	RR-5220/*	5	RRP-209	9	RT-1/01B	34
RR-147/012	20	RR-5220C/*x*	5	RRP-210	9	RT-1/02B	34

INDEX BY PRODUCT NO.

Description	Page	Description	Page	Description	Page	Description	Page
RT-1/04B	34	S-500	71	SD-50C-24	65	SPC-60RP	83
RT-11B	34	S5810SS3	43	SDC-15	65	SPC-8	83
RT-12B	34	S585SS3	43	SDC-20	65	SPRING	73
RT-14B	34	S588SS3	43	SDC-23	65	SPRING B	73
RT-2/01/0B	34	S-600	71	SDC-30	65	SPS-1204UL	64
RT-2/01B	34	SAI-101	82	SDC-5	65	SPS-1206	64
RT-2/02/0B	34	SAI-102	82	SEC-100BRM	64	SS	87
RT-2/02B	34	SAI-103	82	SEC-11	64	SSC25/875	45
RT-2/04B	34	SAI-104	82	SEC-1212	64	SSCGP6SX36	31
RT-22B	34	SAI-105	82	SEC-1223	64	SSCGP6SX36SS	31
RT-24B	34	SAI-106	82	SEC-14	64	SSCGP6SX48	31
RT-2S2SB	34	SAI-107	82	SEC-20	64	SSCGP6SX48SS	31
RT-3/01/0B	34	SAI-108	82	SEC-2450BRM	64	SSCGP6SX60	31
RT-3/01B	34	SAI-201	82	SEC-25	64	SSCGP6SX60SS	31
RT-3/02/0B	34	SAI-202	82	SEC-40BRM	64	SSCGP6SX72	31
RT-3/02B	34	SAI-203	82	SEC-6	64	SSCGP6SX72SS	31
RT-3/03/0B	34	SAI-205	82	SEC-60BRM	64	SSCH15/8	47
RT-3/04B	34	SC2	85	SEC-80BRM	64	SSCH15/8KIT	47
RT-3/163/16B	34	SC229-SFXSNM	70	SGL4-06B2	75	SSCH7/8	47
RT-3/166SB	34	SC320-SF35NM	70	SGL4-10B2	75	SSCH7/8KIT	47
RT-4/01/0B	34	SD-150D-12	65	SL-11A	61	SSDCAA	48
RT-4/01B	34	SD-150D-24	65	SL-11R	61	SSDCH15/8	48
RT-4/02/0B	34	SD-200D-12	65	SL-15R	61	SSDCH7/8	48
RT-4/02B	34	SD-200D-24	65	SL-RACK	66	SSDCSO	48
RT-4/03/0B	34	SD210SF2P2SNM	51, 70	SP440-SF2SNF	70	SSH	87
RT-4/04/0B	34	SD210SF2P4SNM	70	SPC-10	83	SSH-12	75
RT-4/04B	34	SD212SF2P2SNM	70	SPC-10/4	83	SSLRC	87
RT-44B	34	SD212SF2P4SNM	70	SPC-15	83	SSLRCH	87
RT-66B	34	SD-25C-12	65	SPC-15R	83	ST221-SF1SUF (F1610)	68
RT-6S3/16B	34	SD-25C-24	65	SPC-15RP	83	ST321R-SF3SNF (CWH)	68
RT-6S6SB	34	SD310-HF2P2SNM	70	SPC-20	83	ST321-SF4SUF	68
S-200	71	SD314-HF2P2SNM	70	SPC-20R	83	ST-400EZ	78
S-300	71	SD-350D-12	65	SPC-30	83	ST5D	85
S3410SS3	43	SD-350D-24	65	SPC-40RP	83	ST-600C	78
S-400	71	SD-50C-12	65	SPC-5P	83	ST-900C	78

INDEX BY PRODUCT NO.

Description	Page	Description	Page	Description	Page	Description	Page
STP2000A	50	TC-240-BM(A)	78	TTASPNR-2C	22	VD-6B	38
STS-23	80	TC-240-MUHF	78	UB 12180	21	VH-2/oB	39
STS-34	80	TC-240-NMH	78	UB1213	21	VH-25CMB	39
STS-45	80	TC-240-NM-RA(A)	78	UB1250	21	VH-2B	39
SXL-141	40	TC-400-BM	78	UB1280	21	VH-2SB	39
SXL-141.5	40	TC-400-MUHF	78	UB650	21	VH-4/oB	39
SXL-141.52B	40	TC-400-NMH	78	UGK-5	46	VH-4B	39
SXL-141.52C	40	TC-600-NFC-BH	78	UWM25R	24	VH-6B	39
SXL-141.52D	40	TC-600-UMC	78	UWM32R	25	VMN1033	60
SXL-1412B	40	TDN6581A	60	VA-2**B	38	VT-2/oK	39
SXL-1412C	40	TG-4AAR	85	VA-2/o**B	38	VT-25CMB	39
SXL-1412D	40	TG-4AARC	85	VA-2/oB	38	VT-2B	39
SXL-1422B	40	TG-4AAR-E	85	VA-25CMB	38	VT-2SB	39
SXL-1422C	40	TG-4AAR-E-16	85	VA-2B	38	VT-4/oK	39
SXL-1422D	40	TGB-34	72	VA-2S**B	38	VT-4B	39
SXL-181	40	TMB34	73	VA-2SB	38	VT-6B	39
SXL-1812B	40	TSOC.75/1.75	47	VA-4**B	38	W490	73
SXL-1812C	40	TSOC2/2.75	47	VA-4/o**B	38	W540	73
SXL-1812C3/8	40	TSOC3/3.75	47	VA-4/oB	38	WBC-195	75
SXL-1812D	40	TSOC4/4.75	47	VA-4B	38	WBC-200	75
SXL-3161	40	TSOC5/5.75	47	VA-6**B	38	WBC-240	75
SXL-31612B	40	TSOC6/6.75	47	VA-6B	38	WBC-400	75
SXL-31612C	40	TSOCSI1.25/1.75	47	VD-2**B	38	WBC-600	75
SXL-31612C3/8	40	TSOCSI2/2.75	47	VD-2/o**B	38	WP1KIT	45
SXL-31612D	40	TSOCSI3//3.75	47	VD-2/oB	38	WP3KIT	45
SXL-381.5	40	TSOCSI4/4.75	47	VD-25CM**B	38	WP5KIT	45
SXL-381.52B	40	TSOCSI5/5.75	47	VD-25CMB	38	WPLN4138	60
SXL-381.52C	40	TSOCSI6/6.75	47	VD-2B	38		
SXL-381.52D	40	TTA450ES-2	22	VD-2S**B	38		
SXL-382	40	TTA450II-2	22	VD-2SB	38		
SXL-3822B	40	TTABASEES	22	VD-4**B	38		
SXL-3822C	40	TTABIT	22	VD-4/o**B	38		
SXL-3822D	40	TTACOIL-ES/II	22	VD-4/oB	38		
T100	85	TTANUT	22	VD-4B	38		
T100C	85	TTARFA	22	VD-6**B	38		

WE OFFER QUALITY PRODUCTS FROM THE FOLLOWING MANUFACTURERS:

- AC Data Solutions
- Alive Telecom
- Allcom Products
- AN Wireless
- Andrew
- Anritsu
- Antenex
- Antenna Specialists
- Arc Wireless
- Astron
- Astron Wireless Technologies
- AtlasSound
- Axtech
- B-Line
- Band-It
- Bee Electronics
- Belden
- Centurion
- CES Wireless Technologies
- Chicago Hardware
- Commscope
- Communication Specialists
- Comtelco
- CPI Communications
- Crosby
- CSI
- Cushcraft
- Dapa
- DB by Andrew
- DBI Sala
- DDB Unlimited
- DuraComm
- Edysn
- Elk River
- EMI
- EMR Corporation
- EMS Wireless
- Fibergrate
- Gamber Johnson
- Harger
- Hark Systems, Inc.
- Hoffman
- Huber + Suhner
- ICT
- Improved Product Technologies
- Inscape Data
- iTech
- Kathrein Inc., Scala Division
- Lemco Tool Corporation
- Lobo
- Luxul
- Memorylink
- Mobile Mark
- Motorola
- Mounting Systems of America
- Multiplier
- MY-TE
- Mykover
- NABC
- Narda
- Newmar
- NK Cables
- Panasonic
- PCTEL/Maxrad
- Peltor
- Petzl
- Phazar
- Plymouth
- Polyphaser
- Preformed Line Products
- Primus Railroad Products
- Prism Lighting
- Radiall/Larsen
- Radiowaves
- Railroad Products
- Ramsey Electronics
- Renasis
- RF Industries
- RFS Celwave
- RSI
- Samlex America
- Sinclair Technologies
- Speco
- Straight Ahead, Inc.
- STI-CO Industries
- Telephone Components
- Telewave
- Times Microwave Systems
- TJ Cope
- Tripp Lite
- TWR Lighting
- Tyton
- Universal Battery
- Western Towers
- Wireless AC
- Valmont
- ...and more!

PRIMUS

PRIMUS CORPORATE HEADQUARTERS
18424 NORTHWEST FRONTAGE ROAD
JOLIET, ILLINOIS 60431

TOLL-FREE: (800) 435-1636
FAX: (800) 767-7605

SALES@PRIMUSELECTRONICS.COM

