



energy

Wind Power Catalog



Primus is where the wind
takes you for all of your

wind energy
product
needs



...and many more!

CONTENTS

Harnesses	4
Lanyards	8
Rope, Accessories & Storage Bags	10
Anchorage	14
Fall Arrest	15
Rescue	16
Personal Safety Gear	17
Grounding	20
Towers	32
Tower Lighting	38
Wireless Modems	41
Cable & Pipe Seals	42
Lubricants	43
Wind Meters	44
Vertical Climbing Systems	45
Index	46

Skylotec SkyWind Harness

Elk River

Wind Motion Harness

- Three steel D-rings at back and hips
- One O-ring center of chest for ladder climbing
- Five equipment eyelets at waist pad
- Aluminum quick-connect buckles at chest, waist and leg straps
- Lumbar back support
- Tool belt
- Made of nylon and polyester



Mfg	Part #	Description
-----	--------	-------------

Elk River	44402	Skylotec SkyWind Harness, Sizes Small-Large
-----------	-------	---

Elk River	44404	Skylotec SkyWind Harness, Sizes Large-X-Large
-----------	-------	---

Classifications: Class A, Class P, Class L

Standards: ANSI Z359.3-2007; ANSI A 10.32-2004; CSA Z259.10-06

Man-rated 310 lbs.

WindEagle™ LE Harness

Elk River

- Four steel D-rings located at back, hips, and chest
- Quick-connect chest and leg straps
- Large comfort D-ring slider at back
- Removable tool belt
- Waist pads
- Shoulder and leg pads
- Designed for positioning work and rescue
- Hip D-rings support sub-pelvic region
- Made of nylon and polyester



Mfg	Part #	Description
-----	--------	-------------

Elk River	62451	Wind Eagle LE Harness 4-D Back, Size Small
-----------	-------	--

Elk River	62452	Wind Eagle LE Harness 4-D Back, Size Medium
-----------	-------	---

Elk River	62453	Wind Eagle LE Harness 4-D Back, Size Large
-----------	-------	--

Elk River	62454	Wind Eagle LE Harness 4-D Back, Size X-Large
-----------	-------	--

Elk River	62455	Wind Eagle LE Harness 4-D Back, Size 2XL
-----------	-------	--

Elk River	62456	Wind Eagle LE Harness 4-D Back, Size 3XL
-----------	-------	--

Classifications: Class A, Class P, Class D, Class L

Man-rated 400 lbs.

WindEagle™ Harness

Elk River

- Four steel D-rings located at back, hips, and chest
- Quick-connect chest and leg straps
- Large comfort D-slider at back
- Leg pads
- Made of nylon and polyester



Mfg	Part #	Description	Size
-----	--------	-------------	------

Elk River	62432	Wind Eagle Harness 4-D Back	S-L
-----------	-------	-----------------------------	-----

Elk River	62434	Wind Eagle Harness 4-D Back	L-XL
-----------	-------	-----------------------------	------

Classifications: Class A; Class P; Class L

WearMaster® 3-D-Ring Harness

Elk River

- Three steel D-rings: at back and hips
- Parachute mating buckle on chest and leg straps
- Adjustable shoulder straps with shoulder pads
- Removable tool belt
- 4" backpad
- Tongue buckles on leg straps
- Made of polyester and nylon



Mfg	Part #	Description
-----	--------	-------------

Elk River	75301	WearMaster 3-D-Ring Harness, Size Small
-----------	-------	---

Elk River	75302	WearMaster 3-D-Ring Harness, Size Medium
-----------	-------	--

Elk River	75303	WearMaster 3-D-Ring Harness, Size Large
-----------	-------	---

Elk River	75404	WearMaster 3-D-Ring Harness, Size X-Large
-----------	-------	---

Classifications: Class A, Class P

Sizes X-Small, 2XL and 3XL are also available

WearMaster® Series Harness

Elk River

- Three steel D-rings at back and hips
- Parachute mating buckle on chest and leg straps
- Adjustable shoulder straps with shoulder pads
- Removable tool belt
- 4" backpad
- Made of polyester and nylon



Mfg	Part #	Description
-----	--------	-------------

Elk River	74301	WearMaster Series Harness, Size Small
-----------	-------	---------------------------------------

Elk River	74302	WearMaster Series Harness, Size Medium
-----------	-------	--

Elk River	74303	WearMaster Series Harness, Size Large
-----------	-------	---------------------------------------

Elk River	74304	WearMaster Series Harness, Size X-Large
-----------	-------	---

Classifications: Class A, Class P

Sizes X-Small, 2XL and 3XL are also available

ExoFit™ XP Harness

DBI-Sala

Tower Climbing Harness

- Quick-connect buckles
- Back stand-up D-ring; front D-ring
- Padded body belt with side D-rings
- Seat sling with positioning D-rings
- Removable and washable shoulder, back, and leg padding



Mfg	Part #	Description
DBI-Sala	1110300	ExoFit XP Harness, Size Small
DBI-Sala	1110301	ExoFit XP Harness, Size Medium
DBI-Sala	1110302	ExoFit XP Harness, Size Large
DBI-Sala	1110303	ExoFit XP Harness, Size X-Large

OSHA/ANSI/CSA Compliant - North America

ExoFit™ Harness

DBI-Sala

Tower Climbing Harness

- Quick-connect buckles
- Back and front D-rings
- Padded body belt with side D-rings
- Seat sling with positioning D-rings
- Built-in shoulder, back, and leg padding



Mfg	Part #	Description
DBI-Sala	1108650	ExoFit Harness, Size Small
DBI-Sala	1108651	ExoFit Harness, Size Medium
DBI-Sala	1108652	ExoFit Harness, Size Large
DBI-Sala	1108657	ExoFit Harness, Size X-Large

OSHA/ANSI/CSA Compliant - North America

Delta™ II Tower Climbing Harness

DBI-Sala

Tower Climbing Harness

- Delta No-Tangle pad design
- Tongue buckle legs
- Back stand-up D-ring; front D-ring
- Padded body belt with side D-rings
- Seat sling with positioning D-rings



Mfg	Part #	Description
DBI-Sala	1107776	Delta II Tower Climbing Harness, Size Small
DBI-Sala	1107777	Delta II Tower Climbing Harness, Size Medium
DBI-Sala	1107775	Delta II Tower Climbing Harness, Size Large
DBI-Sala	1107778	Delta II Tower Climbing Harness, Size X-Large

OSHA/ANSI/CSA Compliant - North America

Delta™ II Climbing Harness

DBI-Sala

Climbing Harness

- Delta No-Tangle pad design
- Tongue buckle legs
- Back stand-up D-ring; front D-ring



Mfg	Part #	Description
DBI-Sala	1107806	Delta II Climbing Harness, Size Small
DBI-Sala	1107807	Delta II Climbing Harness, Size Medium
DBI-Sala	1107800	Delta II Climbing Harness, Size Large
DBI-Sala	1107803	Delta II Climbing Harness, Size X-Large

OSHA/ANSI/CSA Compliant - North America

Suspension Trauma Safety Strap

DBI-Sala

Harness Accessory

- Allows suspended worker to stand up in their harness to relieve pressure
- Continuous loop design allows for either one or two foot suspension relief without pinching
- Can be quickly attached to most harness brands right in the field



Mfg	Part #	Description
DBI-Sala	9501403	Suspension Trauma Safety Strap



Navaho® Bod Harness

Petzl

Versatile Work Positioning and Fall Arrest Harness

- Excellent balance between suspended comfort and freedom of movement
- Waist belt and shoulder straps equipped with self-locking Double-Back buckles
- Waist belt, leg loops, and shoulder straps lined with breathable perforated foam for maximum comfort when suspended
- Five attachment points (sternal, dorsal, ventral, and two lateral)



Mfg	Part #	Description
Petzl	C71000	Navaho Bod Harness with Self-locking Double-Back Buckles on Leg Loops
Petzl	C710FN	Navaho Bod Fast Fall Arrest Harness with FAST Buckles on Leg Loops, Black

Certifications: ANSI Z359.1; CE EN 361; CE EN 358; CE EN 813, NFPA 1983 Class III; CSA Z259.10

Navaho® Bod Croll Fast Harness

Petzl

Rope Access Harness

- Integrated CROLL ventral rope clamp for ascending ropes
- Excellent balance between suspended comfort and freedom of movement
- Waist belt and shoulder straps equipped with self-locking Double-Back buckles; Leg loops equipped with FAST automatic buckles for quick and easy opening and closing without the need to readjust them



Mfg	Part #	Description
Petzl	C71CF0 1	Navaho Bod Croll Fast Rope Access Harness, Waist Belt: 28"-47"; Leg Loops: 20"-26"; Height: 5-1/4'-6'
Petzl	C71CF0 2	Navaho Bod Croll Fast Rope Access Harness, Waist Belt: 31"-55"; Leg Loops: 24"-30"; Height: 5-3/4'-6-1/2'

Certifications: ANSI Z359.1; CE EN 361; CE EN 358; CE EN 813; CE EN 12841 type B

TechnaCurv Full Body Harness

MSA

- Vest style harness with shoulder and sub-pelvic padding
- Qwik-Fit connector at the chest and secure fit connectors on the legs
- Designed with downward adjusting torso straps to ease adjustment
- Total of 4 D-rings



Mfg	Part #	Description
MSA	10041615	TechnaCurv Full Body Harness with Shoulder & Sub-Pelvic Padding

Meets ANSI Z359.1-2007, ANSI A10.32, all applicable OSHA regulations, and is CSA certified to Z359.10-06

Workman Construction Harness

MSA

- Qwik-fit chest strap with tongue buckles on legs
- Attachment points (D-Ring) on hips and back
- Provides comfortable protection due to its lightweight components and durable webbing
- Comes with integral back pad and shoulder pads



Mfg	Part #	Description
MSA	10077571	Workman Construction Harness with Qwik-fit Chest Strap and Tongue Buckles on Legs

Meets applicable OSHA regulations, ANSI A10.32, ANSI Z359.1-2007, and is certified to CSA Z259.10-06

FP Pro Harness

MSA

- Vest style harness with tongue leg buckles and integral belt and back pad
- Back D-ring and 2 hip D-rings
- Bright red polyester webbing for high visibility
- Lightweight design for increased comfort



Mfg	Part #	Description
MSA	10043033	FR Pro Harness with Tongue Leg Buckles, Integral Belt and Back Pad

Meets all applicable OSHA regulations, ANSI A10.32, ANSI Z359.1-2007

PMI Avatar Harness

PMI

Versatile Harness

- Versatile, comfortable, and useful harness
- Eight attachment points
- Available in two sizes to fit 30" to 55" waists
- Fully adjustable rear leg risers and chest harness
- Ergonomic padding and interchangeable, removable chest harness



Mfg	Part #	Description
PMI	SG51036	PMI Avatar Harness with Dorsal, Sternal, Waist, Hip, Shoulder, and Lumbar Attachments

Meets NFPA 1983 Class III, ANSI Z359.1

heightec-PMI™ Cirrus Twin Harness

PMI

Fall Arrest Harness

- Low-profile, highly breathable jacket protects webbing on user's back from abrasion during ladder climbing
- Leg straps fitted with quick release buckles for convenience
- Removable belt provides versatility for any job
- Extra attachment point allows greater flexibility and forms a dedicated rescue point



Harness shown without belt

Mfg	Part #	Description
PMI	SG51202	heightec-PMI™ Cirrus Twin Full Body Wind Tower Harness with Belt

PMI Avatar Contour Harness

PMI

Rescue Harness

- Lightweight harness designed for those who only need front waist and sternum attachment points
- Fully adjustable rear leg risers and chest harness
- Adjusts to fit 25" to 55" waists
- Ergonomic padding with non-removable chest harness



Mfg	Part #	Description
PMI	SG51155	PMI Avatar Contour Harness with Front Waist and Sternum Attachment Points

Meets NFPA 1983 Class III

heightec-PMI Zero G Harness

PMI

Fire Rescue, Rope Access Harness

- Sophisticated, multi-purpose harness with excellent lumbar support
- Particularly suitable for mast and tower climbing in rope access, telecoms, stage rigging, and rescue; Every type of work at height including positioning, suspension, and fall arrest
- Equipped with side D-rings, and front and rear fall arrest attachment



Mfg	Part #	Description
PMI	SG51198	heightec-PMI Zero G Full Body Harness with Side D-rings

heightec-PMI Nexus Harness

PMI

Fall Arrest Harness

- Suitable for work at height situations
- Sternal ring and dorsal ring provide two attachment points
- Dual adjustment at shoulder and hip
- High tenacity webbing



Mfg	Part #	Description
PMI	SG51201	heightec-PMI Nexus Full Body Harness



Safety

Shock-Absorbing Lanyards

Mfg	Part #	Description
Elk River		
Elk River	35478	1-1/2" x 6' Flex-NoPac® Polyester Twin Leg Web Lanyard, Zsnaphook and Rebar Hook. 3,600 lb. Gate. Stretches 4.5' to 6'.
Elk River	36897	1-1/2" x 6' Flex-ZORBER® Nylon & Polyester Twin Leg Web Lanyard, Zsnaphook and Rebar Form Hook on each leg. 3,600 lb. Gate. Stretches 4.5' to 6'.
Elk River	35678	1-1/2" x 6' Flex-NoPac Nylon & Polyester Twin Leg Web Lanyard, Zsnaphook and Rebar Hook. 3,600 lb. Gate. Stretches 4.5' to 6'.
Elk River	35598	1-1/2" x 6' NoPac Polyester Twin Leg Web Lanyard, Zsnaphook and Rebar Hook on each leg. 3,600 lb. Gate.
DBI-Sala		
DBI Sala	1244409	6' Shockwave2™ Polyester Stretch Double-Leg Shock-Absorbing Lanyard, Aluminum Rebar Hook Ends with 2-1/4" Polyester
DBI Sala	1244406	6' Shockwave2™ Polyester Stretch Double-Leg Shock-Absorbing Lanyard, Standard Snap Hook Ends with 3/4" opening. 3,600 lb. Gate. Stretches 4.5' to 6'.
DBI Sala	1240416	6' EZ-Stop™ II Pack Style Shock Absorbing Lanyard, Double-Leg, Aluminum Rebar Hook Ends with 2-1/4" opening. 3,600 lb. Gate.
DBI Sala	AE542AW2	6' Pro™ Lanyard Shock Absorbing Lanyard, Single-Leg, Standard Snap Hook Ends with 3/4" opening.
Petzl		
Petzl	L57	6' Absorbica Sewn-Webbing Shock Absorbing Lanyard, Ends Equipped with STRING, Compact and Lightweight.
Petzl	L70150 YM	5' (1.5 m) Absorbica-Y MGO Shock Absorbing Y-shaped Lanyard with two Automatic Locking MGO Connectors. Ends Equipped with STRING.
MSA		
MSA	10088259	Sure-Stop™ Single-Leg Adjustable Web Lanyard. Meets ANSI Z359.1-2007.
MSA	10088260	Sure-Stop™ Single-Leg Adjustable Web Lanyard with Pelican Hook on One End. Meets ANSI Z359.1-2007.



Elk River Flex-NoPac Lanyard (35478)



Elk River Flex-ZORBER Lanyard (36897)



Elk River Flex-NoPac Lanyard (35678)



Elk River Flex-NoPac Lanyard (35598)



DBI Sala Shockwave2 (1244406)



DBI Sala EZ-Stop II (1240416)



DBI Sala Pro Lanyard (AE542AW2)



Petzl Absorbica (L57)



Petzl Absorbica Y MGO (L70150 YM)



MSA Sure-Stop (10088259)

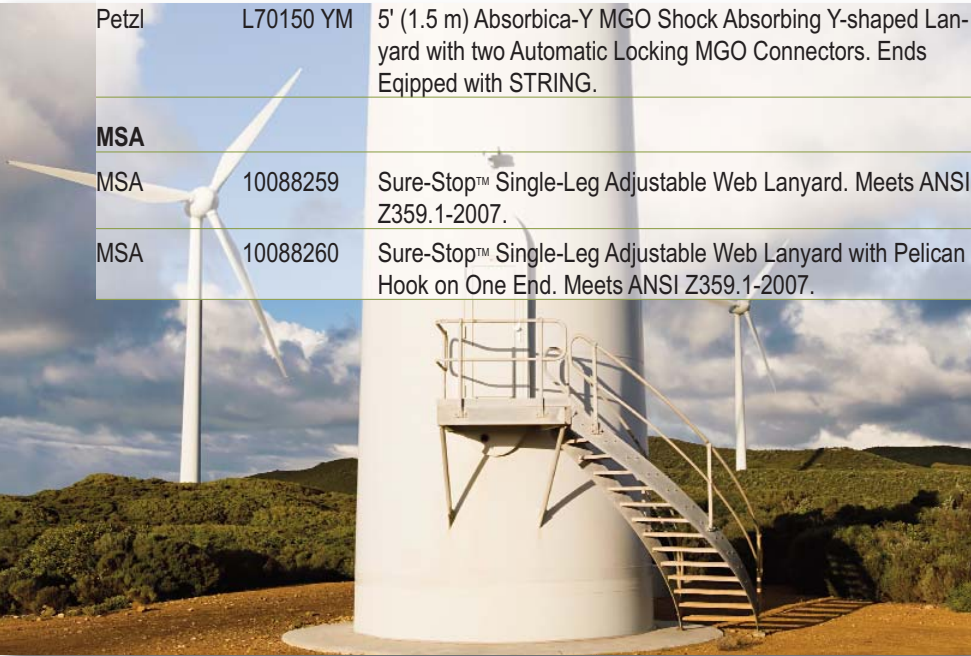

Positioning Lanyards

Mfg	Part #	Description
Elk River		
Elk River	34416	Adjustable Nylon Positioning Lanyard with ErgoGrip Adjuster, 5/8" (16 mm) x 6' (1.8 m). 3,600 lb. Gate. Requires Carabiner (17450).
Elk River	34496	Adjustable Nylon Positioning Lanyard with ErgoGrip Adjuster, 1/2" (12 mm) x 6.5' (2 m). 3,600 lb. Gate. Requires Carabiner (17450).
DBI Sala		
DBI Sala	1232354	6' (1.8 m) Single-Leg Positioning Lanyard with 1/2" (12.7 mm) Nylon Rope and Standard Snap Hook Ends with 3/4" (19 mm) Opening. OSHA/ANSI/CSA Compliant for North America
Petzl		
Petzl	L52 2	Grillon Compact Adjustable Lanyard, 6-1/2' (2 m)
Petzl	L52 3	Grillon Compact Adjustable Lanyard, 9-7/8' (3 m)
Petzl	L52 5	Grillon Compact Adjustable Lanyard, 16-1/2' (5 m)
Petzl	L52 2H	Grillon Hook Adjustable Lanyard with Automatic Locking HOOK Connector, 6-1/2' (2 m)
Petzl	L52 3H	Grillon Hook Adjustable Lanyard with Automatic Locking HOOK Connector, 9-7/8' (3 m)
Petzl	L52 3MG	Grillon MGO Adjustable Lanyard with Automatic Locking MGO Connector
Petzl	L50 60	Jane Non-Adjustable Dynamic Rope Lanyard, Black, 2' (0.6 m)
Petzl	L50 100	Jane Non-Adjustable Dynamic Rope Lanyard, Black, 3-1/4' (1 m)
Petzl	L50 150	Jane Non-Adjustable Dynamic Rope Lanyard, Black, 5' (1.5 m)
Petzl	L50 200	Jane Non-Adjustable Dynamic Rope Lanyard, Black, 6-1/2' (2 m)
Petzl	C49	Footpro Large Adjustable Foot Loop
MSA		
MSA	SNYR537DH306	Sure-Grab™ Positioning Lanyard, 5/8" x 6' Static Kernmantle, Chrome Locking Swivel Snaphook, Right-Handed Version
MSA	SNYL537DH306	Sure-Grab™ Positioning Lanyard, 5/8" x 6' Static Kernmantle, Chrome Locking Swivel Snaphook, Left-handed Version
MSA	505063	Cable Restraint Lanyard, 1/4" Steel Cable Lanyard with Snaphooks on Both Ends, 6' Long



Elk River Adj. Nylon 5/8" x 6' Lanyard (34416)

Elk River Adj. Nylon 5/8" x 6' Lanyard (34496)



DBI Sala Single-Leg Positioning Lanyard (1232354)



Petzl Grillon Hook (L52 2H)

Petzl Grillon MGO (L52 3MG)



Petzl Jane Lanyards (L50_)



MSA Sure-Grab Lanyard (SNYR537DH306)



Petzl Footpro (C49)



Squids Tool Lanyard in Black & Lime (3100)

Squids Detachable Tool Lanyard in Lime (3102)
 *Tool not included

Tool Lanyards

Tethers tools to help worker prevent injury, damage, and lost productivity from dropped tools

Mfg	Part #	Description
Ergodyne		
Ergodyne	3100	Squids® Tool Lanyard with Single Aluminum Carabiner. Available in Black and Lime Colors.
Ergodyne	3102	Squids® Detachable Tool Lanyard with Single Aluminum Carabiner. Available in Black and Lime Colors.

Safety

Ascenders and Descenders

Mfg	Part #	Description
Elk River		
Elk River	19700*	Ascender, Right Hand, Red, 8-1/2" x 3-1/4" for Rope Sizes 3/8" (9 mm) and 1/2" (13 mm)
Elk River	19701*	Ascender, Right Hand, Green, 8-1/2" x 3-1/4" for Rope Sizes 3/8" (9 mm) and 1/2" (13 mm)
Petzl		
Petzl	B17R	Ascension Ascender, Right Hand, Blue, for Single Ropes between 3/8" (8 mm) and 1/2" (13 mm)
Petzl	B17L	Ascension Ascender, Left Hand, Yellow, for Single Ropes between 3/8" (8 mm) and 1/2" (13 mm)
Petzl	B16	Croll Chest Ascender for Single Ropes Between 3/8" (8 mm) and 1/2" (13 mm)
Petzl	D20S	I'D Self-Braking Descender Belay Device with Anti-Panic Function. For Working on Fixed Ropes (with safety clip on the swinging plate and for rope diameters from 10 mm to 11.5 mm.
Petzl	D20L	I'D Self-Braking Descender Belay Device with Anti-Panic Function. For Rescue (without safety clip and for rope diameters from 11.5 mm to 13 mm.
PMI		
PMI	HD26183	heightec-PMI™ PULSAR Ascender, Aluminum
PMI	HD26184	heightec-PMI™ COMPACT Ascender, Aluminum
PMI	HD26185	heightec-PMI™ TWIST Ascender, Aluminum
MSA		
MSA	SDSD25	Descender, Cast Aluminum, for use with 7/16" (11 mm) Diameter Rope.

*Professional training required to use these devices.

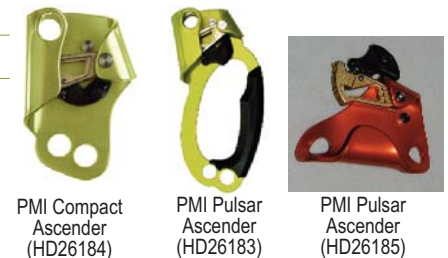
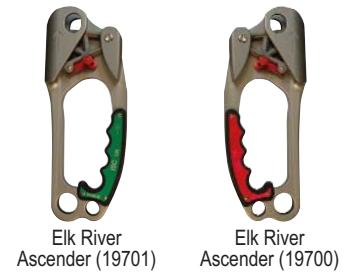

Rope Grabs

Mfg	Part #	Description
Elk River		
Elk River	19100	1/2" Kernmantle Rope Grab with 2" Ring
Elk River	19200	5/8" Trailing Rope Grab with 2" Ring
Elk River	19401	3/8" Wire Rope Grab
DBI Sala		
DBI Sala	6116502	Ladder Safety 3/8" (8 mm) Wire Rope Grab with Attached Carabiner
DBI Sala	6116540	Cable Ladder Safety System, 3/8" (8 mm) for the Wind Energy Sector
DBI Sala	5000335	Lad-Saf® Mobile Rope Grab for use on 5/8" (16 mm) Rope with a 3' (0.9 m) Max Length Shock Absorbing Lanyard
DBI Sala	5000338	Lad-Saf® Static Wire Rope Grab for use on 3/8" (9.5 mm) 7x9 Galvanized or Stainless Steel Cable. Use with a 4' (1.2 m) Max Length Shock Absorbing Lanyard.
Petzl		
Petzl	B71	ASAP® Mobile Fall Arrester for Rope. Comes with OK TRIACT Automatic Locking Carabiner.



Kernmantle Rope



Petzl Vector Rope

Mfg	Part #	Description
Petzl		
Petzl	R892 O	8 mm Rescue Cord, 300' (92 m), Orange
Petzl	R892 R	8 mm Rescue Cord, 300' (92 m), Red
Petzl	R892 G	8 mm Rescue Cord, 300' (92 m), Green
Petzl	R892 B	8 mm Rescue Cord, 300' (92 m), Black
Petzl	R11183R	Vector 11 mm, 600' (183 m) Red
Petzl	R12183Y	Vector 12.5 mm, 600' (183 m) Yellow
Nova Blue		
Novatec Braids	NB12600	1/2" x 600' Poly Double Braid 10,400 lb
Novatec Braids	NB121200	1/2" x 1200' Poly Double Braid 10,400 lb
Novatec Braids	NB58600	5/8" x 600' Poly Double Braid 15,500 lb
Novatec Braids	NB581200	5/8" x 1200' Poly Double Braid 15,500 lb

Rope Accessories



Canvas Rope Pad
(RC48027)

Supermantle Rope Guard
(RC48021)

Spiroll® Rope Protector
(RC48032)

Mfg	Part #	Description
PMI		
Rope Guards		
PMI	RC48021*	PMI Supermantle Rope Guard, Bright, 18"
PMI	RC48022*	PMI Supermantle Rope Guard, Bright, 24"
PMI	RC48023*	PMI Supermantle Rope Guard, Bright, 36"
Rope Pads		
PMI	RC48010	Canvas Rope Pad, Small, 12" x 33"
PMI	RC48026	Canvas Rope Pad, Medium, 30" x 34"
PMI	RC48027	Canvas Rope Pad, Large, 60" x 34"
Rope Protectors		
PMI	RC48032	Spiroll® Rope Protector, Orange, 23.5"
PMI	RC48033	Spiroll® Rope Protector, Black, 23.5"

*Also available in black



PMI Rope

Mfg	Part #	Description
PMI		
<i>White/Black</i>		
PMI	RR110WB046E	150' (46 m) White/Black
PMI	RR110WB061E	200' (61 m) White/Black
PMI	RR110WB092E	300' (92 m) White/Black
PMI	RR110WB183E	600' (183 m) White/Black
<i>Red/Black</i>		
PMI	RR110RB046E	150' (46 m) Red/Black
PMI	RR110RB061E	200' (61 m) Red/Black
PMI	RR110RB092E	300' (92 m) Red/Black
PMI	RR110RB183E	600' (183 m) Red/Black
<i>Yellow/Black</i>		
PMI	RR110YB046E	150' (46 m) Yellow/Black
PMI	RR110YB061E	200' (61 m) Yellow/Black
PMI	RR110YB092E	300' (92 m) Yellow/Black
PMI	RR110YB183E	600' (183 m) Yellow/Black
<i>Orange/Black</i>		
PMI	RR110OB046E	150' (46 m) Orange/Black
PMI	RR110OB061E	200' (61 m) Orange/Black
PMI	RR110OB092E	300' (92 m) Orange/Black
PMI	RR110OB183E	600' (183 m) Orange/Black

Other Colors and diameters available

Tool Pouch



Mfg	Part #	Description
Ergodyne		
Ergodyne	5516	Arsenal® 16-Pocket Aerial Tool Pouch with three Nickel-plated D-rings for Tool Lanyard Attachment

Safety

Bags and Storage

Mfg	Part #	Description
Elk River		
Elk River	84303	EZE-Man® Rope Bag, 12"x16", Holds up to 450' (137 m) of 1/2" (12 mm) Diameter Kernmantle Rope
Elk River	84521	Red Canvas Bolt Bag, 2.5"x9"x10" Deep, Belt Tunnel with Draw String
Elk River	84221	Sturdy Red Weather Resistant Bag, 11"x24"x14" Deep
Elk River	84231	Sturdy Camo Weather Resistant Bag, 11"x24"x14" Deep
Petzl		
Petzl	R40	Standard Rope Bag, Holds up to 200' (60 m) of 1/2" (12 mm) Rope. Available in Blue, Orange, Yellow, Red, Black.
Petzl	R41	Rope Bucket, Holds up to 200' (60 m) of 1/2" (12 mm) Rope. Available in Blue, Orange, Yellow, Red, Black.
PMI		
<i>Medium Rope Pack, Holds 328' (100 m) of 7/16" (11 mm) Rope</i>		
PMI	RB44043	Medium Black Rope Pack, 10.5"x20"
PMI	RB44042	Medium Blue Rope Pack, 10.5"x20"
PMI	RB44041	Medium Red Rope Pack, 10.5"x20"
PMI	RB44040	Medium Orange Rope Pack, 10.5"x20"
<i>Large Rope Pack, Holds 393' (120 m) of 7/16" (11 mm) Rope</i>		
PMI	RB44019	Large Black Rope Pack, 16"x 23"
PMI	RB44020	Large Blue Rope Pack, 16"x 23"
PMI	RB44021	Large Red Rope Pack, 16"x 23"
PMI	RB44028	Large Orange Rope Pack, 16"x 23"
<i>X-Large Rope Pack, Holds 656' (200 m) of 7/16" (11 mm) Rope</i>		
PMI	RB44058	X-Large Black Rope Pack, 16.5"x 24"
PMI	RB44023	X-Large Blue Rope Pack, 16.5"x 24"
PMI	RB44024	X-Large Red Rope Pack, 16.5"x 24"
PMI	RB44029	X-Large Orange Rope Pack, 16.5"x 24"
Straight Ahead		
Straight Ahead, Inc.	SA-101-ADF-(Color)*	Tool Bag with Clips, Drawstring, Long Radio Pouch. 12" Tall, 1 Exterior Pocket, 2 Interior Pockets, 2 Interior Elastic Secure Straps
Straight Ahead, Inc.	SA-101-AEF-(Color)*	Tool Bag, Snap w/flap, Drawstring, Short Cell Pocket. 12" Tall, 1 Exterior Pocket, 2 Interior Pockets, 2 Interior Elastic Secure Straps
Straight Ahead, Inc.	SA-101-BDF-(Color)*	Tool Bag with Hooks, Drawstring Long Radio Pocket. 12" Tall, 1 Exterior Pocket, 2 Interior Pockets, 2 Interior Elastic Secure Straps
Straight Ahead, Inc.	SA-101-BEF-(Color)*	Tool Bag with Snap Hook, Drawstring, Short Cell Pocket. 12" Tall, 1 Exterior Pocket, 2 Interior Pockets, 2 Interior Elastic Secure Straps
Straight Ahead, Inc.	SA-102-(Color)	Large Gear Bag, 16" Tall X 28" Long X 15" Deep, 1 Exterior Zippered Pocket, 1 Exterior ID Slot, Removable Hard Bottom
Straight Ahead, Inc.	SA-106-RD	Red Emergency Rescue Bag. Dual Compartment, Bottom Section Designed to hold 300' of Rope and the Top Section to Hold Your Rescue Equipment. 16" Tall X 28" Long x 15" Deep, 1 Exterior Zippered Pocket



Elk River EZE-Man Rope Bag (84303)



Elk River Red Canvas Bolt Bag (84521)



Petzl Rope Bucket (R41)



PMI Rope Pack (RB44021)



Straight Ahead Tool Bag (SA-101-BDF-OR)



Straight Ahead Large Gear Bag (SA-102-YE)

Carabiners

Mfg	Part #	Description
Elk River		
Elk River	17426	Steel Carabiner, 2-1/4" Gate 3,600 lb.
Elk River	17435	Steel Carabiner, 2" Gate 3,600 lb.
Elk River	17443	Steel Carabiner, 1" Gate 3,600 lb.
Elk River	17451	Steel Carabiner, 3/4" Gate 3,600 lb.
Elk River	17450	Steel Carabiner, 1/2" Gate 3,600 lb.
DBI-Sala		
DBI-Sala	2000114	Steel Carabiner, 2-3/16" (55 mm) Gate 3,600 lb.
DBI-Sala	2000113	Steel Carabiner, 1-3/16" (30 mm) Gate 3,600 lb.
DBI-Sala	2000112	Steel Carabiner, 11/16" (17 mm) Gate 3,600 lb.
MSA		
MSA	10089209	Steel Carabiner, 2.1" (53 mm) Gate 3,600 lb.
MSA	10089207	Steel Carabiner, 1" (25 mm) Gate 3,600 lb.

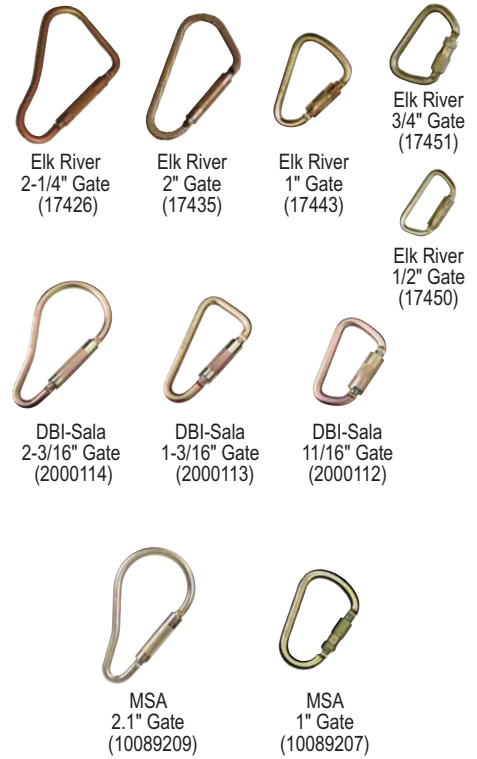

Rigging Plates

Mfg	Part #	Description
Petzl		
Petzl	P63 S	Small Aluminum Paw Rigging Plate with 19 mm Holes
Petzl	P63 M	Medium Aluminum Paw Rigging Plate with 19 mm Holes
Petzl	P63 L	Large Aluminum Paw Rigging Plate with 19 mm Holes
PMI		
PMI	SM130301N	Black SMC Mini Rigging Plate with Large Carabiner Holes
PMI	SM130302N	Blue SMC Mini Rigging Plate with Large Carabiner Holes
PMI	SM130005	Red SMC NFPA Rigging Plate with Numbered Holes for Quick Identification

Safety

Anchorage

Mfg	Part #	Description
Elk River		
Elk River	26773	EZE-Man™ Sling, 1-3/4" x 3' Length with Triangle and D-Ring
Elk River	26793	EZE-Man™ Sling, 1-3/4" x 3' Length with Web Eye and D-Ring
Elk River	29886	Cable Sling, 1/4" x 6' Vinyl Coated Cable GAC
Elk River	63673	Eagle Tie-off Sling, 1" x 3' Full Length Wear Pad with 4" Half Loop Web Eye on both Ends
Elk River	63786	WindEagle™ Anchor Sling, 1-3/4" x 6' with 4" Half Loop Web Eye on both Ends. 400 lbs. Man-rated.
DBI Sala		
DBI Sala	1003000	Tie-off Adaptor, Pass-thru Design, 3' (0.9 m) Length. Polyester Strap.
DBI Sala	2101630	D-Ring & Anchorage Plate. Bolted or Weld On, Two 1/2" (12 mm) Attachment Holes.
DBI Sala	5900550	Cable Choker, Psss-Thru Design, 4' (1.2 m) Length. Stainless Steel Cable.
DBI Sala	AN112A	Eyebolt Anchor, D-Ring Anchor with Threaded Bolt, Nut, and Lock Washer
DBI Sala	2104519	First-Man-Up™ System. Provides a Complete System to Mount a Tie-off Adapter to an Overhead Anchorage. 6'-12' Adjustable Pole.
Petzl		
Petzl	C42 100	Connexion Fixe Anchoring Strap with Forged Steel D-rings, 3-1/4' (1 m)
Petzl	C42 150	Connexion Fixe Anchoring Strap with Forged Steel D-rings, 5' (1.5 m)
Petzl	C42 200	Connexion Fixe Anchoring Strap with Forged Steel D-rings, 6-1/2' (2 m)
Petzl	C42 V	Connexion Vario Adjustable Anchoring Strap with Forged D-rings. Length Adjusts from 2-2/3' to 4-1/4' (0.8 m to 1.3 m). Strength Rating: 22kN.
Petzl	C42 F	Connexion Fast Adjustable Pick-off Strap. Length Adjusts from 1/3' to 5' (0.1 m to 1.5 m). Strength rating: 18kN.
PMI		
PMI	SG51213	PMI Choker Sling, 3'
PMI	SG51214	PMI Choker Sling, 6'
PMI	HD26165	heightec-PMI™ Steel Sling, 7 mm x 1 m
PMI	HD26166	heightec-PMI™ Steel Sling, 7 mm x 2 m
MSA		
MSA	SFP2267503	Double D-ring Anchorage Connector Strap, 3' Length
MSA	SFP2267504	Double D-ring Anchorage Connector Strap, 4' Length
MSA	SFP2267506	Double D-ring Anchorage Connector Strap, 6' Length
MSA	SFP3267504	SuretyMan™ Anchorage Cable Sling, 4' Length
MSA	SFP3267506	SuretyMan™ Anchorage Cable Sling, 6' Length
MSA	506632	D-plate Anchorage Connector, Zinc-Plated Steel

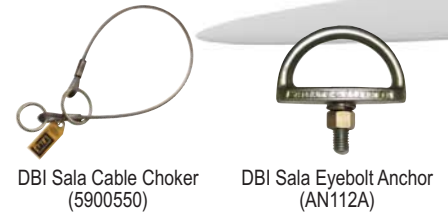

Petzl Connexion Fixe (C42)



Self-Retracting Lifelines (SRLs)

Mfg	Part #	Description
Elk River		
Elk River	21915	Panther® Series SRL, 3/16" Diameter Galvanized Steel Cable, 15' Cable
Elk River	21920	Panther® Series SRL, 3/16" Diameter Galvanized Steel Cable, 20' Cable
Elk River	21930	Panther® Series SRL, 3/16" Diameter Galvanized Steel Cable, 30' Cable
Elk River	21950	Panther® Series SRL, 3/16" Diameter Galvanized Steel Cable, 50' Cable
Elk River	21965	Panther® Series SRL, 3/16" Diameter Galvanized Steel Cable, 65' Cable
Elk River	21402	Cable SRL, 3/16" Cable with Swivel Snaphook, 25' Cable
Elk River	21403	Cable SRL, 3/16" Cable with Swivel Snaphook, 50' Cable
Elk River	21803	Recovery SRL, 3/16" Cable with Swivel Snaphook, 50' Cable
DBI Sala		
DBI Sala	3102000	Talon™ Twin Leg 6' (1.8 m) Web SRL with two Velcro Lanyard Keepers and Aluminum Rebar Hook Ends with 2-1/4" (57 mm) Opening.
DBI Sala	3102003	Talon™ Twin Leg 6' (1.8 m) Web SRL with two Velcro Lanyard Keepers and Steel Hook Ends with 2-1/4" (57 mm) Opening.
DBI Sala	3101001	Talon™ 8' (2.4 m) Web SRL, Swiveling Snap Hook End with 3/4" (19 mm) Opening.
DBI Sala	3101000	Talon™ 8' (2.4 m) Web SRL, Non-swiveling Snap Hook End with 3/4" (19 mm) Opening.
DBI Sala	AD111A	Rebel™ 11' (3.3 m) Web SRL, Swiveling Snap Hook End with 3/4" (19 mm) Opening.
DBI Sala	3103208	Ultra-Lok® 20' (6 m) Web SRL, Swiveling Snap Hook End with 3/4" (19 mm) Opening.
DBI Sala	3103108	Ultra-Lok® 11' (3.3 m) Web SRL, Swiveling Snap Hook End with 3/4" (19 mm) Opening.
DBI Sala	3504430	Ultra-Lok® 30' (9 m) Cable SRL, Swiveling Snap Hook End with 3/4" (19 mm) Opening.
MSA		
MSA	506615	Dyna-Lock® 20' (6 m) Nylon Web SRL. Meets Ansi Z359.1-2007 Standards.
MSA	506203	Dyna-Lock® 30' (10 m) Stainless Steel Wire Rope SRL. Meets ANSI Z359.1-2007 Standards.
MSA	506205	Dyna-Lock® 50' (16 m) Stainless Steel Wire Rope SRL. Meets ANSI Z359.1-2007 Standards.
MSA	10017931	Dyna-Lock® 20' (6 m) Wire Rope SRL. Meets ANSI Z359.1-2007 Standards.



Elk River Panther Series SRLs (21915-21965)



Elk River Cable SRL (21402)



Talon Web SRL (3101001)



Rebel Web SRL (AD111A)



Ultra-Lok Web SRL (3103108)



Talon Twin Leg Web SRL (3102000)



Ultra-Lok Web SRL (3103108)



MSA Dyna-Lock SRL (506615)



MSA Dyna-Lock SRL (10017931)



MSA Dyna-Lock SRL (10017931)

Safety

High Angle Rescue

Mfg	Part #	Description
Elk River		
Elk River	19905	EZE-Man® Auto Descent/Self Rescue Device with Hub* (Lifting Function), 50'
Elk River	19910	EZE-Man® Auto Descent/Self Rescue Device with Hub*(Lifting Function), 100'
Elk River	19915	EZE-Man® Auto Descent/Self Rescue Device with Hub*(Lifting Function), 150'
Elk River	19920	EZE-Man® Auto Descent/Self Rescue Device with Hub*(Lifting Function), 200'
Elk River	19925	EZE-Man® Auto Descent/Self Rescue Device with Hub*(Lifting Function), 250'
Elk River	19930	EZE-Man® Auto Descent/Self Rescue Device with Hub*(Lifting Function), 300'
Elk River	19935	EZE-Man® Auto Descent/Self Rescue Device with Hub*(Lifting Function), 350'



Elk River EZE-Man with Hub (19930)



Elk River EZE-Man without Hub

DBI Sala		
DBI Sala	8902004	RollGliss® Rescue System, 50' with 3:1 Ratio
DBI Sala	8902206	RollGliss® Rescue System, 100' with 3:1 Ratio
DBI Sala	8900292	RollGliss® Rescue Kit with 7/16" (11 mm) Nylon Lifeline, 33' (16.5 m)
DBI Sala	8900293	RollGliss® Rescue Kit with 7/16" (11 mm) Nylon Lifeline, 66' (33 m)
DBI Sala	8900294	RollGliss® Rescue Kit with 7/16" (11 mm) Nylon Lifeline, 99' (50 m)



DBI-Sala RollGliss (8902004)



DBI-Sala RollGliss (8900292)



Petzl Pro Traxion (P51) Petzl Mini Traxion (P07) Petzl Gemini (P66) Petzl Twin (P65)



Petzl Rescue (P50) Petzl Mini Pulley (P59) Petzl Minder (P60)



PMI TowerPack (KT36120)

PMI ScaffPack (KT36113)



PMI Workseat (HD26188)

Rescue/Termination Plates

Mfg	Part #	Description
Petzl		
Petzl	P51	Pro Traxion Very Efficient Self-Jamming Pulley
Petzl	P07	Mini Traxion Compact and Lightweight Self-Jamming Pulley
Petzl	P05	Fixe Single Pulley with Fixed Side Plates
Petzl	P50	Rescue Single Pulley with Swinging Side Plates
Petzl	P59	Mini Lightweight Prusik Pulley
Petzl	P66	Gemini Double Prusik Pulley
Petzl	P60	Minder Highly Efficient Prusik Pulley
Petzl	P65	Twin Highly Efficient Double Prusik Pulley
PMI		
PMI	KT36120	heightec-PMI™ TowerPack™ Self-Evacuation/Rescue System with 216' (66 m) of Rope with Carrying Bag
PMI	KT36121	heightec-PMI™ TowerPack™ Self-Evacuation/Rescue System with 328' (100 m) of Rope with Carrying Bag
PMI	KT36113	heightec-PMI™ ScaffPack™ Compact Rescue System with 164' (50 m) of Rope with Carrying Bag
PMI	KT36114	heightec-PMI™ ScaffPack™ Compact Rescue System with 216' (66 m) of Rope with Carrying Bag
PMI	KT36115	heightec-PMI™ ScaffPack™ Compact Rescue System with 328' (100 m) of Rope with Carrying Bag
PMI	HD26188	heightec-PMI™ Workseat, Rope Access Workseat (Bo'suns Chair)



Petzl Vertex Best Duo
 Helmet (E66W1)



Petzl Vertex Best
 Helmet with Chinstrap
 (A16W1)



Petzl Vertex Vent
 Helmet (A11Y1)



PMI Advantage Helmet
 (HL33014)



PMI Ventilated Helmet
 (HL33060)



MSA Standard V-Gard Helmet with Fas-Trac
 Suspension (475371 & 475366)

Helmets

Mfg	Part #	Description
Petzl		
Petzl	E66W1	Vertex Best Duo LED 14 Helmet with Integrated Headlamp (Lighting 100 m)
Petzl	A16(Color)1	Vertex Best Helmet with Chinstrap. Available in Yellow, White, Red, Orange, Black.
Petzl	A11(Color)1	Vertex Vent Helmet, Ventilated with Chinstrap. Available in Yellow, White, Red, Orange, Black.
PMI		
PMI	HL33014	White PMI Advantage Helmet with Chinstrap. ANSI Z89.1 Type 1 Certified.
PMI	HL33011	Orange PMI Advantage Helmet with Chinstrap. ANSI Z89.1 Type 1 Certified.
PMI	HL33012	Red PMI Advantage Helmet with Chinstrap. ANSI Z89.1 Type 1 Certified.
PMI	HL33013	Blue PMI Advantage Helmet with Chinstrap. ANSI Z89.1 Type 1 Certified.
PMI	HL33013	Blue PMI Advantage Helmet with Chinstrap. ANSI Z89.1 Type 1 Certified.
PMI	HL33060	Silver Ventilated Helmet with Chinstrap. ANSI Z89.1 Type 1 Certified.
PMI	HL33068	Red Ventilated Helmet with Chinstrap. ANSI Z89.1 Type 1 Certified.
MSA		
MSA	475369	White Standard V-Gard Helmet with Fas-Trac Suspension
MSA	475358	Blue Standard V-Gard Helmet with Fas-Trac Suspension
MSA	475366	Yellow Standard V-Gard Helmet with Fas-Trac Suspension
MSA	475371	Red Standard V-Gard Helmet with Fas-Trac Suspension
MSA	475370	Green Standard V-Gard Helmet with Fas-Trac Suspension

Helmet Accessories

Mfg	Part #	Description
Petzl		
Petzl	E72AC	Duo® LED 14 ACCU Hybrid Waterproof Headlamp with Rechargeable Battery
Petzl	E02P	e+Lite Emergency Headlamp
Petzl	E47 PBZ	Tikka® Plus Headlamp with Three Lighting Levels. Black and Yellow.
Petzl	E48 PBZ	Zipka® Plus Headlamp with Three Lighting Levels Mounted on a Retractable Cord
Petzl	E81 PHZ	Tikka® XP Hazloc Headlamp with Three Lighting Levels, Boost Mode, and Wide Angle Lens. Meets US Standards (UL Certification).
Petzl	E86900	Adapt-Tikka Multi-Mount System for the Tikka-Zipka Headlamps
PMI		
PMI	HG32021	Cosmo Headlamp, Eight Brightness Settings and Strobe
PMI	HG32023	Spot Headlamp, Three Brightness Settings and Strobe
PMI	HG32024	Icon Headlamp, Eight Brightness Settings
MSA		
MSA	10087220	Fas-Trac Replacement Suspension
MSA	81391	Elastic Chin Strap for V-Gard, Attaches to Suspension
MSA	88128	Plastic Chin Strap for V-Gard, Attaches to Helmet Shell



Petzl e+Lite (E02P)



Petzl Zipka Plus
 (E48 PBZ)



Petzl Tikka Plus (E47 PBZ)



Petzl Tikka XP (E81 PHZ)



PMI Cosmo (HG32021)



Petzl Adapt-Tikka (E86900)



PMI Icon (HG32024)



MSA Elastic Chin Strap (81391)

Safety

Gloves



Proflex (710)



Cordex Plus (K53)



Rope Tech (GL22304)

Mfg	Part #	Description
Ergodyne		
Ergodyne	710	Proflex® Full-Fingered Trades Gloves with Superb Dexterity, Function and Protection. Available in Small, Medium, Large, X-Large and XX-Large
Petzl		
Petzl	K53	Cordex Plus Midweight Belay/Rappel Glove. Available in Black or Tan and in Sizes Small, Medium, Large and X-Large.
PMI		
PMI	GL22302	Rope Tech Lightweight Gloves, Small
PMI	GL22303	Rope Tech Lightweight Gloves, Medium
PMI	GL22304	Rope Tech Lightweight Gloves, Large
PMI	GL22305	Rope Tech Lightweight Gloves, X-Large
PMI	GL22306	Rope Tech Lightweight Gloves, XX-Large

Safety Vests



Mfg	Part #	Description
Ergodyne		
Ergodyne	8252Z	GLOWEAR® Class 2 Vest with D-ring Access. ANSI-Certified Polyester Mesh (3.3 oz) and 2" Level 2 ANSI-Certified Tape. P5 Pockets, Available in Colors Lime and Orange.

Protective Eyewear



MSA Easy Flex Clear (10070917)



MSA Easy Flex Blue (10070920)



MSA Alpine Gray (10041820)



Willson Clear Lens (11150510)



MSA Easy Flex Gray (10070918)



MSA Easy Flex Sky Orange (10070921)



MSA Alpine Gold (10041823)



Willson Gray Lens (11150511)



MSA Easy Flex Amber (10070919)



MSA Alpine Clear (10041818)



MSA Rx Overglasses (10008175)

Mfg	Part #	Description
MSA		
MSA	10070917	Easy Flex, Clear Lens, Blue-gray Frame
MSA	10070918	Easy Flex, Gray Lens, Blue-gray Frame
MSA	10070919	Easy Flex, Amber Lens, Blue-gray Frame
MSA	10070920	Easy Flex, "180 Blue" Mirror Lens, Blue-gray Frame
MSA	10070921	Easy Flex, "Sky Orange" Mirror Lens, Metallic Sand Frame
MSA	10041818	Alpine Eyewear with Clear Lens
MSA	10041819	Alpine Eyewear with Clear Anti-fog Lens
MSA	10041820	Alpine Eyewear with Gray Lens
MSA	10041823	Alpine Eyewear with Light Gold Indoor/Outdoor Lens
MSA	10012855	Rx Overglasses, Blue Frame with Gray Anti-fog Lens. Fits over Most Prescription Glasses.
MSA	10008175	Rx Overglasses, Clear Anti-fog Lens. Fits over Most Prescription Glasses.
Willson		
Willson	11150510	Clear Lens Safety Glasses, ANSI-Rated
Willson	11150511	Gray Lens Safety Glasses, ANSI-Rated

Webbing Straps

Mfg	Part #	Description
PMI Etrier		
PMI	SG51040	4-Step Etrier, Red with Blue Color, 4' 3" Length
PMI	SG51034	5-Step Etrier, Red with Blue Color, 5' 3" Length
PMI	SG51096	6-Step Etrier, Orange with Blue Color, 6' 3" Length



6-Step Etrier (GL22304)

Medical Kit

An affordable yet thorough first aid kit, the Weekender Medical Kit from Adventure Medical Kits is outfitted with the Easy Care System—an ingenious design that helps anyone – from novices to EMTs – quickly and confidently administer first aid.

Features:

- The kit organizes hospital-quality supplies and instructions into injury-specific compartments – from fractures and sprains to wound care, burns, and blisters.
- Designed to support groups of up to 7 people for up to a week long trip.
- Medical information includes "Comprehensive Guide to Wilderness & Travel Medicine" and "Illustrated Guide to Life-Threatening Emergencies."
- Essential equipment includes 1 CPR Barrier MicroShield, 1 pair of EMT Shears, 1 Non-Mercury Thermometer, 1 Duct Tape and 1 Splinter Picker Forceps.
- Wound management items include 3 Double Antibiotic Ointments, 6 Antiseptic Towelettes, 2 Tincture of Benzoin, 1 20cc. Irrigation Syringe, 2 Povidone Iodine Solution (1 oz.) and 5 Wound Closure Strips.
- Blister items include 1 Moleskin, 2 Spenco 2nd Skin (1.5 x 2) and 1 Non-woven Adhesive Knit Bandage (7 x 4).
- Bandage materials include (8) 4 x 4 or 3 x 3 or 2 x 2's Sterile Dressing, 3 Non-adherent Sterile Dressing (3 x 4), Adhesive Tape 10 yards (1"), 13 Strip and Knuckle Bandages, (2) 8x10.
- Also includes include 3 Extra Strength Tylenol, 2 Antihistamines, 2 Motrin, 3 Safety Pins, 1 Accident Report and Pencil.



Mfg	Part #	Description
Adventure Medical Kits	WEEKENDER	Weekender Medical Kit. Weight: 1 lb., 10 oz Dimensions: 8.5" x 7" x 4"



Grounding

One-Hole Long Barrel Compression Lugs

- Manufactured from electroplated tinned copper
- For use on copper or tinned copper conductors

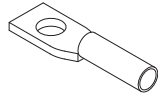

Mfg	Part #	Description
Harger	GECLB6	#6 Blue 1-Hole Long Barrel Lug, 1/4" Hole
Harger	GECLB63/8	#6 Blue 1-Hole Long Barrel Lug, 3/8" Hole
Harger	GECLB1/0	1/0 Pink 1-Hole Long Barrel Lug, 3/8" Hole
Harger	GECLB2/0	2/0 Black 1-Hole Long Barrel Lug, 3/8" Hole
Harger	GECLB4/0	4/0 Purple 1-Hole Long Barrel Lug, 1/2" Hole

Other sizes may be available

Two-Hole Long Barrel Compression Lugs

- Manufactured from electroplated tinned copper
- For use on copper or tinned copper conductors
- Lugs have inspection ports

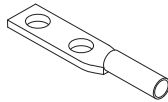

Mfg	Part #	Description
Harger	GECLB62C	#6 Blue 2-Hole Long Barrel Lug, 3/8" Holes, 1" Space
Harger	GECLB22B	#2 Brown 2-Hole Long Barrel Lug, 3/8" Holes, 3/4" Space
Harger	GECLB22BS	#2 Sol White 2-Hole Long Barrel Lug, 3/8" Holes, 3/4" Space
Harger	GECLB22C	#2 Brown 2-Hole Long Barrel Lug, 3/8" Holes, 1" Space
Harger	GECLB22CS	#2 Sol White 2-Hole Long Barrel Lug, 3/8" Holes, 1" Space
Harger	GECLB1/02C	1/0 Pink 2-Hole Long Barrel Lug, 3/8" Hole, 1" Space
Harger	GECLB1/02D	1/0 Pink 2-Hole Long Barrel Lug, 1/2" Hole, 1-3/4" Space
Harger	GECLB2/02C	2/0 Black 2-Hole Long Barrel Lug, 3/8" Hole, 1" Space
Harger	GECLB2/02D	2/0 Black 2-Hole Long Barrel Lug, 1/2" Hole, 1-3/4" Space
Harger	GECLB4/02C	4/0 Purple 2-Hole Long Barrel Lug, 3/8" Hole, 1" Space
Harger	GECLB4/02D	4/0 Purple 2-Hole Long Barrel Lug, 1/2" Hole, 1-3/4" Space
Harger	GECLB2502D	250MCM Yellow 2-Hole Long Barrel Lug, 1/2" Hole, 1-3/4" Space
Harger	GECLB5002D	500MCM Brown 2-Hole Long Barrel Lug, 1/2" Hole, 1-3/4" Space
Harger	GECLB7502D	750MCM Black, 2-Hole Long Barrel Lug, 1/2" Hole, 1-3/4" Space

Slotted Long Barrel Compression Lugs

- Manufactured from electroplated tinned copper
- For use on copper or tinned copper conductors

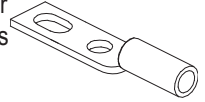

Mfg	Part #	Description
Harger	GECLB62BC	#6 Blue 2-Hole Slot Long Barrel Lug, 3/8" Holes, 3/4"-1" Space
Harger	GECLB22BCS	#2 Sol White 2-Hole Slot Long Barrel Lug, 3/8" Holes, 3/4"-1" Space
Harger	GECLB22BC	#2 Brown 2-Hole Slot Long Barrel Lug, 3/8" Holes, 3/4"-1" Space

Available in 250 piece buckets

C-Taps

- Connects two copper conductors together with either a hydraulic or hand-held crimp tool



Heavy Duty C-Tap



Light Duty C-Tap

Mfg	Part #	Description
<i>Heavy Duty C-Taps - Hydraulic tool needed</i>		
Harger	CT4666	Heavy Duty C-Tap #4 through #8
Harger	CT4446	Heavy Duty C-Tap #4 through #4
Harger	CT2248	Heavy Duty C-Tap #2 through #8
Harger	CT2222	Heavy Duty C-Tap #2 through #2
Harger	CT22/0	Heavy Duty C-Tap #2 through 2/0
Harger	CT24/0	Heavy Duty C-Tap #2 through 4/0
Harger	CT2/02/0	Heavy Duty C-Tap 2/0 through 2/0
Harger	CT4/02/0	Heavy Duty C-Tap 4/0 through 2/0
Harger	CT4/04/0	Heavy Duty C-Tap 4/0 through 4/0
<i>Light Duty C-Taps - Hand-held crimp tool needed</i>		
Harger	CT4666LD	Light Duty C-Tap #4 through #6
Harger	CT2248LD	Light Duty C-Tap #2 through #8
Harger	CT2222LD	Light Duty C-Tap #2 through #2

Mechanical Compression Tools

Dieless Compression Tool

- Dieless adjustable compression tool with steel handle
- Works with copper conductor sizes #8 through 250MCM and aluminum conductors #8 through 4/0
- For use with compression lugs and light duty compression taps



Mfg	Part #	Description
Harger	MCT	Dieless Compression Tool #8 through 4/0

Compression Tool with Die

- Handy compression tool terminates copper compression connectors in wire sizes #6 through #2 Sol
- Handle length facilitates two-handed crimps when necessary
- Includes dies



Mfg	Part #	Description
Harger	MCT81/0M	Compression Tool with Die #6 through #2 SOL

Universal Ground Bar Kits



GBU14412M



GBU14420M

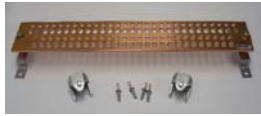

GBU14424M

Mfg	Part #	Description
Harger	GBU14412M	4" x 12" Universal Ground Bar with Hardware
Harger	GBU14420M	4" x 20" Universal Ground Bar with Hardware
Harger	GBU14424M	4" x 24" Universal Ground Bar with Hardware

Ask about our tamper resistant hardware. Other sizes, hole patterns, and custom etching may be available. Call Primus at (800) 435-1636 to discuss options.

Rebar Grounding Assemblies

- Prefabricated rebar grounding assembly
- Exothermically welded connection
- Standard 24" long rebar
- Can be wire tied or welded to rebar cage prior to concrete pour

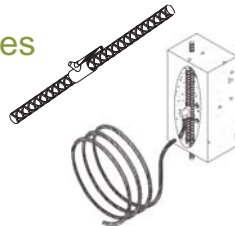

Mfg	Part #	Description
Harger	RB6GA4/0X15	#6 Rebar Grounding Assembly, 4/0 15' Lead

Other sizes are available

Cable to Cable BS

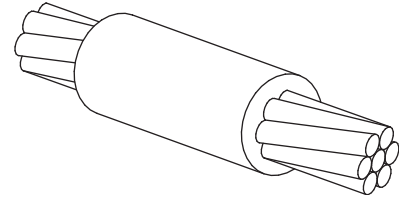

Butt End Splice of Horizontal Cables

Mfg	Part #	Description	Weld Metal
Harger	BS4L	#4 Std to #4 Std	UWM25
Harger	BS3L	#3 Std to #3 Std	UWM32
Harger	BS2L	#2 Std to #2 Std	UWM32
Harger	BS2SL	#2 Sol to #2 Sol	UWM32
Harger	BS1L	#1 Std to #1 Std	UWM32
Harger	BS1/0B	1/0 to 1/0	UWM45
Harger	BS2/0B	2/0 to 2/0	UWM65
Harger	BS3/0B	3/0 to 3/0	UWM90
Harger	BS4/0B	4/0 to 4/0	UWM90

Other sizes are available

Cable to Cable PB

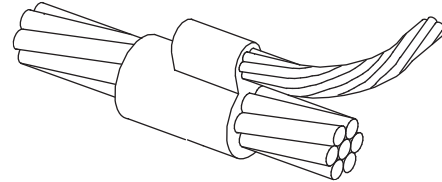

Parallel Tap of Horizontal Cables

Mfg	Part #	Description	Weld Metal
Harger	PB48SB	#4 Std Run to #8 Sol Tap	UWM32
Harger	PB46SB	#4 Std Run to #6 Sol Tap	UWM32
Harger	PB46B	#4 Std Run to #6 Std Tap	UWM32
Harger	PB44B	#4 Std Run to #4 Std Tap	UWM32
Harger	PB2S2SB	#2 Sol Run to #2 Sol Tap	UWM65
Harger	PB28SB	#2 Std Run to #8 Sol Tap	UWM32
Harger	PB26SB	#2 Std Run to #6 Sol Tap	UWM32
Harger	PB26B	#2 Std Run to #6 Std Tap	UWM32
Harger	PB24B	#2 Std Run to #4 Std Tap	UWM45
Harger	PB22B	#2 Std Run to #2 Std Tap	UWM65
Harger	PB18SB	#1 Std Run to #8 Sol Tap	UWM45
Harger	PB16SB	#1 Std Run to #6 Sol Tap	UWM45
Harger	PB16B	#1 Std Run to #6 Std Tap	UWM45
Harger	PB14B	#1 Std Run to #4 Std Tap	UWM45
Harger	PB12B	#1 Std Run to #2 Std Tap	UWM65
Harger	PB11B	#1 Std Run & Tap	UWM65

Other sizes are available

Grounding

Grounding

Cable to Cable **PS**

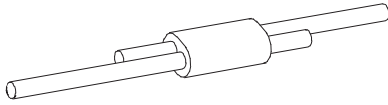

Parallel Thru Splice of Horizontal Cables

Mfg	Part #	Description	Weld Metal
Harger	PS8S8SL	#8 Sol to #8 Sol	UWM15
Harger	PS88L	#8 Std to #8 Std	UWM15
Harger	PS6S6SL	#6 Sol to #6 Sol	UWM25
Harger	PS66L	#6 Std to #6 Std	UWM25
Harger	PS4S4SM	#4 Sol to #4Sol	UWM32
Harger	PS44M	#4 Std to #4 Std	UWM32

Other sizes are available

Cable to Cable **XO**

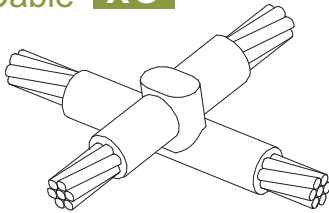

Cross of Horizontal Cables, Lapped and Not Cut

Mfg	Part #	Description	Weld Metal
Harger	XO24B	#2 Std to #4 Std	UWM65
Harger	XO22B	#2 Std to #2 STD	UWM90
Harger	XO14B	#1 Std to #4 Std	UWM90
Harger	XO12B	#1 Std to #2 Std	UWM90
Harger	XO11B	#1 Std to #1 Std	UWM115
Harger	XO1/04Q	1/0 to #4 Std	UWM115
Harger	XO1/02Q	1/0 to #2 Std	UWM115
Harger	XO1/01Q	1/0 to #1 Std	UWM150
Harger	XO1/01/0Q	1/0 to 1/0	UWM150
Harger	XO2/02Q	2/0 to #2 Std	UWM150
Harger	XO2/01Q	2/0 to #1 Std	UWM150
Harger	XO2/01/0Q	2/0 to 1/0	UWM200
Harger	XO2/02/0Q	2/0 to 2/0	UWM200
Harger	XO3/02Q	3/0 to #2 Std	UWM150
Harger	XO3/01Q	3/0 to #1 Std	UWM150
Harger	XO3/01/0Q	3/0 to 1/0	UWM200
Harger	XO3/02/0Q	3/0 to 2/0	UWM200
Harger	XO3/03/0Q	3/0 TO 3/0	UWM250
Harger	XO4/02Q	4/0 to #2 Std	UWM150
Harger	XO4/01Q	4/0 to #1 Std	UWM150
Harger	XO4/01/0Q	4/0 to 1/0	UWM200
Harger	XO4/02/0Q	4/0 to 2/0	UWM200
Harger	XO4/03/0Q	4/0 to 3/0	UWM250
Harger	XO4/04/0Q	4/0 to 4/0	UWM250

Other sizes are available

Cable to Cable **PT**

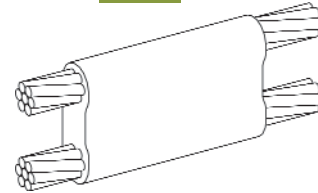

Parallel Thru Splice of Horizontal Cables, Tap Conductor Over Run

Mfg	Part #	Description	Weld Metal
Harger	PT2S2SB	#2 Sol to #2 Sol	UWM65
Harger	PT8S8SB	#8 Sol to #8 Sol	UWM45

Other sizes are available

Cable to Cable **RT**

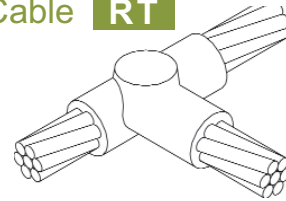

Tee of Horizontal Run & Tap Cables

Mfg	Part #	Description	Weld Metal
Harger	RT44B	#4 Std to #4 STD	UWM32
Harger	RT2S2SB	#2 Sol to #2 Sol	UWM45
Harger	RT24B	#2 Std to #4 Std	UWM45
Harger	RT22B	#2 Std to #2 Std	UWM45
Harger	RT14B	#1 Std to #4 Std	UWM45
Harger	RT12B	#1 Std to #2 Std	UWM45
Harger	RT11B	#1 Std to #1 Std	UWM45
Harger	RT1/04B	1/0 to #4 Std	UWM45
Harger	RT1/02B	1/0 to #2 Std	UWM45
Harger	RT1/01B	1/0 to #1 Std	UWM45
Harger	RT1/01/0B	1/0 to 1/0	UWM90
Harger	RT2/04B	2/0 to #4 Std	UWM45
Harger	RT2/02B	2/0 to #2 Std	UWM45
Harger	RT2/01B	2/0 to #1 Std	UWM45
Harger	RT2/01/0B	2/0 to 1/0	UWM90
Harger	RT2/02/0B	2/0 to 2/0	UWM90
Harger	RT3/04B	3/0 to #4 Std	UWM45
Harger	RT3/02B	3/0 to #2 Std	UWM45
Harger	RT3/01B	3/0 to #1 Std	UWM45
Harger	RT3/01/0B	3/0 to 1/0	UWM90
Harger	RT3/02/0B	3/0 to 2/0	UWM90
Harger	RT3/03/0B	3/0 to 3/0	UWM115
Harger	RT4/04B	4/0 to #4 Std	UWM90
Harger	RT4/02B	4/0 to #2 Std	UWM90
Harger	RT4/01B	4/0 to #1 Std	UWM90
Harger	RT4/01/0B	4/0 to 1/0	UWM90
Harger	RT4/02/0B	4/0 to 2/0	UWM90
Harger	RT4/03/0B	4/0 to 3/0	UWM115
Harger	RT4/04/0B	4/0 to 4/0	UWM150

Other sizes are available

Cable to Ground Rod **GD**

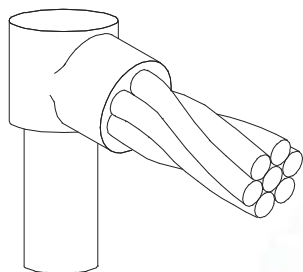

Single Cable Dead Ended to Top of Ground Rod

Mfg	Part #	Description	Weld Metal
Harger	GD124L	#4 Std to 1/2" Grd Rod	UWM25
Harger	GD122B	#2 Std to 1/2" Grd Rod	UWM65
Harger	GD121B	#1 Std to 1/2" Grd Rod	UWM65
Harger	GD121/0B	1/0 to 1/2" Grd Rod	UWM90
Harger	GD122/0B	2/0 to 1/2" Grd Rod	UWM90
Harger	GD123/0B	3/0 to 1/2" Grd Rod	UWM90
Harger	GD124/0B	4/0 to 1/2" Grd Rod	UWM90
Harger	GD584L	#4 Std to 5/8" Grd Rod	UWM32
Harger	GD582SB	#2 Sol to 5/8" Grd Rod	UWM65
Harger	GD582B	#2 Std to 5/8" Grd Rod	UWM65
Harger	GD581B	#1 Std to 5/8" Grd Rod	UWM65
Harger	GD581/0B	1/0 to 5/8" Grd Rod	UWM90
Harger	GD582/0B	2/0 to 5/8" Grd Rod	UWM90
Harger	GD583/0B	3/0 to 5/8" Grd Rod	UWM90
Harger	GD584/0B	4/0 to 5/8" Grd Rod	UWM90
Harger	GD344L	#4 Std to 3/4" Grd Rod	UWM45
Harger	GD342SB	#2 Sol to 3/4" Grd Rod	UWM90
Harger	GD342B	#2 Std to 3/4" Grd Rod	UWM90
Harger	GD341B	#1 Std to 3/4" Grd Rod	UWM90

Other sizes are available

Cable to Ground Rod **GO**

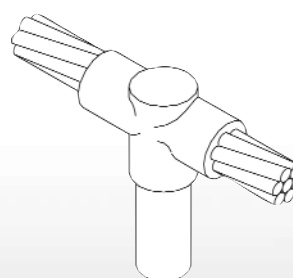

Horizontal Thru Cable to Top of Ground Rod

Mfg	Part #	Description	Weld Metal
Harger	GO124L	#4 Std to 1/2" Grd Rod	UWM32
Harger	GO122SB	#2 Sol to 1/2" Grd Rod	UWM90
Harger	GO122B	#2 Std to 1/2" Grd Rod	UWM90
Harger	GO121B	#1 Std to 1/2" Grd Rod	UWM90
Harger	GO121/0B	1/0 to 1/2" Grd Rod	UWM90
Harger	GO122/0B	2/0 to 1/2" Grd Rod	UWM90
Harger	GO123/0B	3/0 to 1/2" Grd Rod	UWM115
Harger	GO124/0B	4/0 to 1/2" Grd Rod	UWM115
Harger	GO584L	#4 Std to 5/8" Grd Rod	UWM32
Harger	GO582SB	#2 Sol to 5/8" Grd Rod	UWM90
Harger	GO582B	#2 Std to 5/8" Grd Rod	UWM90
Harger	GO581B	#1 Std to 5/8" Grd Rod	UWM90
Harger	GO581/0B	1/0 to 5/8" Grd Rod	UWM90
Harger	GO582/0B	2/0 to 5/8" Grd Rod	UWM115
Harger	GO583/0B	3/0 to 5/8" Grd Rod	UWM115
Harger	GO584/0B	4/0 to 5/8" Grd Rod	UWM115
Harger	GO344M	#4 Std to 3/4" Grd Rod	UWM65
Harger	GO342SB	#2 Sol to 3/4" Grd Rod	UWM90
Harger	GO342B	#2 Std to 3/4" Grd Rod	UWM90
Harger	GO341B	#1 Std to 3/4" Grd Rod	UWM90
Harger	GO341/0B	1/0 to 3/4" Grd Rod	UWM115
Harger	GO342/0B	2/0 to 3/4" Grd Rod	UWM115
Harger	GO343/0B	3/0 to 3/4" Grd Rod	UWM115
Harger	GO344/0B	4/0 to 3/4" Grd Rod	UWM115

Other sizes are available

Cable to Steel Surface **VD**

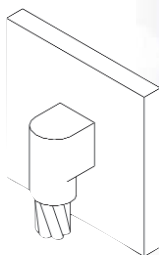

Vertical Downward Cable to Vertical Flat Steel Surface

Mfg	Part #	Description	Weld Metal
Harger	VD4B	#4 Std to Flat Steel	UWM65
Harger	VD2SB	#2 Sol to Flat Steel	UWM65
Harger	VD2B	#2 Std to Flat Steel	UWM65
Harger	VD1B	#1 Std to Flat Steel	UWM90
Harger	VD1/0B	1/0 Std to Flat Steel	UWM115
Harger	VD2/0B	2/0 to Flat Steel	UWM115
Harger	VD3/0B	3/0 to Flat Steel	UWM150
Harger	VD4/0B	4/0 to Flat Steel	UWM150

Other sizes are available

Grounding

Cable to Steel Surface **HD**

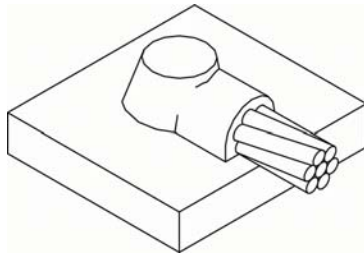

Horizontal Cable to Horizontal Flat Steel Surface, ON Surface

Mfg	Part #	Description	Weld Metal
Harger	HD6SA	#6 Sol to Flat Steel	UWM45
Harger	HD6A	#6 Std to Flat Steel	UWM45
Harger	HD4A	#4 Std to Flat Steel	UWM45
Harger	HD2SA	#2 Sol to Flat Steel	UWM45
Harger	HD2A	#2 Std to Flat Steel	UWM45
Harger	HD1A	#1 Std to Flat Steel	UWM65
Harger	HD1/0B	1/0 to Flat Steel	UWM90
Harger	HD2/0B	2/0 to Flat Steel	UWM90
Harger	HD3/0B	3/0 to Flat Steel	UWM115
Harger	HD4/0B	4/0 to Flat Steel	UWM115

Other sizes are available

Cable to Steel Surface/Pipe **VA**

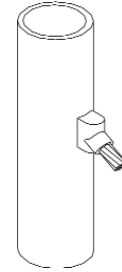

Cable Down at 45° to Side of Vertical or Horizontal Steel Pipe

Mfg	Part #	Description	Weld Metal
Harger	VA4V1.5X4B	#4 Std to 1.5-4" Pipe	UWM45
Harger	VA4V4X6B	#4 Std to 4-6" Pipe	UWM45
Harger	VA4V6X10B	#4 Std to 6-10" Pipe	UWM45
Harger	VA4V12X30B	#4 Std to 12-30" Pipe	UWM45
Harger	VA2SV.5X1B	#2 Sol to .5-1" Pipe	UWM45
Harger	VA2SV1.5X4B	#2 Sol to 1.5-4" Pipe	UWM45
Harger	VA2SV4X6B	#2 Sol to 4-6" Pipe	UWM45
Harger	VA2SV6X10B	#2 Sol to 6-10" Pipe	UWM45
Harger	VA2SV12X30B	#2 Sol to 12-30" Pipe	UWM45
Harger	VA2V1.5X4B	#2 Std to 1.5-4" Pipe	UWM45
Harger	VA2V4X6B	#2 Std to 4-6" Pipe	UWM45
Harger	VA2V6X10B	#2 Std to 6-10" Pipe	UWM45
Harger	VA2V12X30B	#2 Std to 12-30" Pipe	UWM45
Harger	VA1V2X4B	#1 Std to 2-4" Pipe	UWM65
Harger	VA1V4X6B	#1 Std to 4-6" Pipe	UWM65
Harger	VA1V6X10B	#1 Std to 6-10" Pipe	UWM65
Harger	VA1V12X30B	#1 Std to 12-30" Pipe	UWM65
Harger	VA1/0V2X4B	1/0 to 2-4" Pipe	UWM90
Harger	VA1/0V4X6B	1/0 to 4-6" Pipe	UWM90
Harger	VA1/0V6X10B	1/0 to 6-10" Pipe	UWM90
Harger	VA1/0V12X30B	1/0 to 12-30" Pipe	UWM90
Harger	VA2/0V2X4B	2/0 to 2-4" Pipe	UWM90
Harger	VA2/0V4X6B	2/0 to 4-6" Pipe	UWM90
Harger	VA2/0V6X10B	2/0 to 6-10" Pipe	UWM90
Harger	VA2/0V12X30B	2/0 to 12-30" Pipe	UWM90
Harger	VA3/0V2X4B	3/0 to 2-4" Pipe	UWM115
Harger	VA3/0V4X6B	3/0 to 4-6" Pipe	UWM115
Harger	VA3/0V6X10B	3/0 to 6-10" Pipe	UWM115
Harger	VA3/0V12X30B	3/0 to 12-30" Pipe	UWM115
Harger	VA4/0V2X4B	4/0 to 2-4" Pipe	UWM115
Harger	VA4/0V4X6B	4/0 to 4-6" Pipe	UWM115
Harger	VA4/0V6X10B	4/0 to 6-10" Pipe	UWM115
Harger	VA4/0V12X30B	4/0 to 12-30" Pipe	UWM115

Other sizes are available

Cable to Steel Surface **VA**

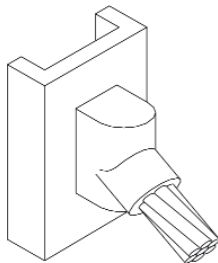

Cable Down at 45° to Vertical Flat Steel Surface

Mfg	Part #	Description	Weld Metal
Harger	VA4B	#4 Std to Flat Steel	UWM45
Harger	VA3B	#3 Std to Flat Steel	UWM45
Harger	VA2SB	#2 Sol to Flat Steel	UWM45
Harger	VA2B	#2 Std to Flat Steel	UWM45
Harger	VA1B	#1 Std to Flat Steel	UWM65
Harger	VA1/0B	1/0 to Flat Steel	UWM90
Harger	VA2/0B	2/0 to Flat Steel	UWM90
Harger	VA3/0B	3/0 to Flat Steel	UWM115
Harger	VA4/0B	4/0 to Flat Steel	UWM115

Other sizes are available

Cable to Bus Bar BE

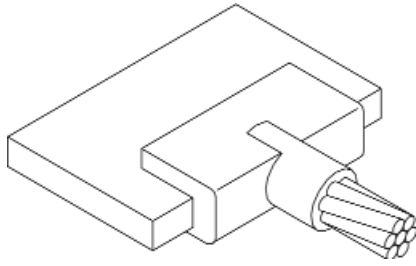

Horizontal Cable Tap to Edge of Horizontal Flat Bus Bar

Mfg	Part #	Description	Weld Metal
Harger	BE141.56B	#6 Std to 1/4"x1.5" & Wider Bar	UWM65
Harger	BE141.52SB	#2 Sol to 1/4"x1.5" & Wider Bar	UWM65
Harger	BE141.52B	#2 Std to 1/4"x1.5" & Wider Bar	UWM65
Harger	BE141.51/0B	1/0 to 1/4"x1.5" & Wider Bar	UWM90
Harger	BE141.52/0B	2/0 to 1/4"x1.5" & Wider Bar	UWM90
Harger	BE141.53/0B	3/0 to 1/4"x1.5" & Wider Bar	UWM90
Harger	BE141.54/0B	4/0 to 1/4"x1.5" & Wider Bar	UWM90
Harger	BE381.51/0B	1/0 to 3/8"x1.5" & Wider Bar	UWM90
Harger	BE381.52/0B	2/0 to 3/8"x1.5" & Wider Bar	UWM90
Harger	BE381.53/0B	3/0 to 3/8"x1.5" & Wider Bar	UWM115
Harger	BE381.54/0B	4/0 to 3/8"x1.5" & Wider Bar	UWM115
Harger	BE121.51/0B	1/0 to 1/2"x1.5" & Wider Bar	UWM115
Harger	BE121.52/0B	2/0 to 1/2"x1.5" & Wider Bar	UWM115
Harger	BE121.53/0B	3/0 to 1/2"x1.5" & Wider Bar	UWM150
Harger	BE121.54/0B	4/0 to 1/2"x1.5" & Wider Bar	UWM150

Other sizes are available

Cable to Rebar RE

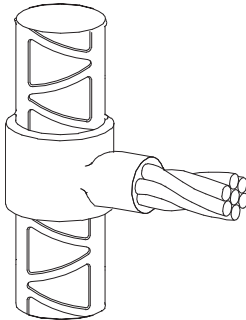

Tee of Vertical Thru Rebar & Horizontal Tap Cable

Mfg	Part #	Description	Packing Mat'l No.	Weld Metal
Harger	RE34B	#4 Std to #3 Rebar	WRPSLV	UWM65
Harger	RE32B	#2 Std to #3 Rebar	WRPSLV	UWM65
Harger	RE31B	#1 Std to #3 Rebar	WRPSLV	UWM90
Harger	RE31/0B	1/0 to #3 Rebar	WRPSLV	UWM115
Harger	RE32/0B	2/0 to #3 Rebar	WRPSLV	UWM115
Harger	RE33/0B	3/0 to #3 Rebar	WRPSLV	UWM150
Harger	RE34/0B	4/0 to #3 Rebar	WRPSLV	UWM150
Harger	RE44B	#4 Std to #4 Rebar	WRPSLV	UWM65
Harger	RE42B	#2 Std to #4 Rebar	WRPSLV	UWM65
Harger	RE41B	#1 Std to #4 Rebar	WRPSLV	UWM90
Harger	RE41/0B	1/0 to #4 Rebar	WRPSLV	UWM115
Harger	RE42/0B	1/0 to #4 Rebar	WRPSLV	UWM115
Harger	RE43/0B	3/0 to #4 Rebar	WRPSLV	UWM150
Harger	RE44/0B	4/0 to #4 Rebar	WRPSLV	UWM150
Harger	RE54B	#4 to #5 Rebar	WRPSLV	UWM65
Harger	RE52B	#2 Std to #5 Rebar	WRPSLV	UWM65
Harger	RE51B	#1 to #5 Rebar	WRPSLV	UWM90
Harger	RE51/0B	1/0 to #5 Rebar	WRPSLV	UWM115
Harger	RE52/0B	2/0 to #5 Rebar	WRPSLV	UWM115
Harger	RE53/0B	3/0 to #5 Rebar	WRPSLV	UWM150
Harger	RE54/0B	4/0 to #5 Rebar	WRPSLV	UWM150
Harger	RE64B	#4 Std to #6 Rebar	WRPSLV	UWM65
Harger	RE62B	#2 Std to #6 Rebar	WRPSLV	UWM65
Harger	RE61B	#1 Std to #6 Rebar	WRPSLV	UWM90
Harger	RE61/0B	1/0 to #6 Rebar	WRPSLV	UWM115
Harger	RE62/0B	2/0 to #6 Rebar	WRPSLV	UWM115
Harger	RE63/0B	3/0 to #6 Rebar	WRPSLV	UWM150
Harger	RE64/0B	4/0 to #6 Rebar	WRPSLV	UWM150

Other sizes are available



Grounding

Cable to Rebar

RO

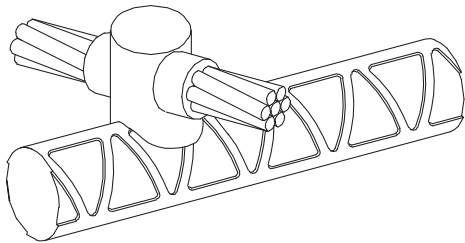

Cross of Horizontal Cable Lapped Over Horizontal Rebar

Mfg	Part #	Description	Packing Mat'l No.	Weld Metal
Harger	RO38SB	#8 Sol to #3 Rebar	WRPSLV	UWM65
Harger	RO48SB	#8 Sol to #4 Rebar	WRPSLV	UWM65
Harger	RO58SB	#8 Sol to #5 Rebar	WRPSLV	UWM65
Harger	RO36B	#6 Std to #3 Rebar	WRPSLV	UWM65
Harger	RO34B	#4 Std to #3 Rebar	WRPSLV	UWM65
Harger	RO32B	#2 Std to #3 Rebar	WRPSLV	UWM90
Harger	RO31B	#1 Std to #3 Rebar	WRPSLV	UWM90
Harger	RO31/0Q	1/0 to #3 Rebar	WRPSLV	UWM115
Harger	RO32/0Q	2/0 to #3 Rebar	WRPSLV	UWM115
Harger	RO33/0Q	3/0 to #3 Rebar	WRPSLV	UWM150
Harger	RO34/0Q	4/0 to #3 Rebar	WRPSLV	UWM150
Harger	RO46B	#6 Std to #4 Rebar	WRPSLV	UWM65
Harger	RO44B	#4 Std to #4 Rebar	WRPSLV	UWM65
Harger	RO42B	#2 Std to #4 Rebar	WRPSLV	UWM90
Harger	RO41Q	#1 Std to #4 Rebar	WRPSLV	UWM90
Harger	RO41/0Q	1/0 to #4 Rebar	WRPSLV	UWM115
Harger	RO42/0Q	2/0 to #4 Rebar	WRPSLV	UWM115
Harger	RO43/0Q	3/0 to #4 Rebar	WRPSLV	UWM150
Harger	RO44/0Q	4/0 to #4 Rebar	WRPSLV	UWM150
Harger	RO56B	#6 Std to #5 Rebar	WRPSLV	UWM65
Harger	RO54B	#4 Sol to #5 Rebar	WRPSLV	UWM65
Harger	RO52B	#2 Std to #5 Rebar	WRPSLV	UWM90
Harger	RO51Q	#1 Std to #5 Rebar	WRPSLV	UWM90
Harger	RO51/0Q	1/0 to #5 Rebar	WRPSLV	UWM115
Harger	RO52/0Q	2/0 to #5 Rebar	WRPSLV	UWM115
Harger	RO53/0Q	3/0 to #5 Rebar	WRPSLV	UWM150
Harger	RO54/0Q	4/0 to #5 Rebar	WRPSLV	UWM150
Harger	RO6L6B	#6 Std to #6 & Larger Rebar	CERPM1	UWM65
Harger	RO6L4B	#4 Std to #6 & Larger Rebar	CERPM1	UWM65
Harger	RO6L2B	#2 Std to #6 & Larger Rebar	CERPM1	UWM90
Harger	RO6L1B	#1 Std to #6 & Larger Rebar	CERPM1	UWM90
Harger	RO6L1/0B	1/0 to #6 & Larger Rebar	CERPM1	UWM115
Harger	RO6L2/0B	2/0 to #6 & Larger Rebar	CERPM1	UWM115
Harger	RO6L3/0B	3/0 to #6 & Larger Rebar	CERPM1	UWM150
Harger	RO6L4/0B	4/0 to #6 & Larger Rebar	CERPM1	UWM150

Cable to Rebar RP

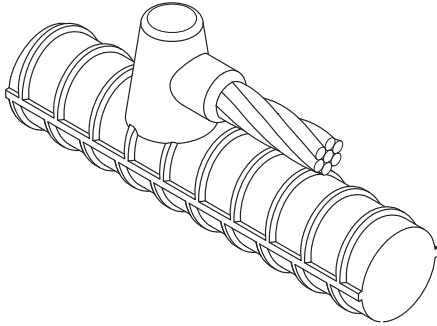

Parallel Cable Tap of Horizontal Cable to Thru Horizontal Rebar

Mfg	Part #	Description	Packing Mat'l	No. Weld Metal
Harger	RP36B	#6 Std to #3 Rebar	WRPSLV	UWM25
Harger	RP34B	#3 Std to #3 Rebar	WRPSLV	UWM32
Harger	RP32B	#2 Std to #3 Rebar	WRPSLV	UWM45
Harger	RP31B	#1 Std to #3 Rebar	WRPSLV	UWM65
Harger	RP31/0B	1/0 to #3 Rebar	WRPSLV	UWM90
Harger	RP32/0B	2/0 to #3 Rebar	WRPSLV	UWM90
Harger	RP33/0B	/0 to #3 Rebar	WRPSLV	UWM115
Harger	RP34/0B	4/0 to #3 Rebar	WRPSLV	UWM115
Harger	RP38SB	#8 Sol to #3 Rebar	WRPSLV	UWM25
Harger	RP4L6A	#6 Std to #4 & Larger Rebar	CERPM1	UWM25
Harger	RP4L4A	#4 Std to #4 & Larger Rebar	CERPM1	UWM32
Harger	RP4L2A	#2 Std to #4 & Larger Rebar	CERPM1	UWM45
Harger	RP4L1A	#1 Std to #4 & Larger Rebar	CERPM1	UWM65
Harger	RP41/0B	1/0 to #4 Rebar	WRPSLV	UWM90
Harger	RP42/0B	2/0 to #4 Rebar	WRPSLV	UWM90
Harger	RP43/0B	3/0 to #4 Rebar	WRPSLV	UWM115
Harger	RP44/0B	4/0 to #4 Rebar	WRPSLV	UWM115
Harger	RP51/0B	1/0 to #5 Rebar	WRPSLV	UWM90
Harger	RP52/0B	2/0 to #5 Rebar	WRPSLV	UWM90
Harger	RP53/0B	3/0 to #5 Rebar	WRPSLV	UWM115
Harger	RP54/0B	4/0 to #5 Rebar	WRPSLV	UWM115
Harger	RP6L1/0B	1/0 to #6 & Larger Rebar	CERMP2	UWM90
Harger	RP6L2/0B	2/0 to #6 & Larger Rebar	CERMP2	UWM90
Harger	RP6L3/0B	3/0 Str - #6 and Larger Rebar	CERMP2	UWM115
Harger	RP6L4/0B	4/0 to #6 & Larger Rebar	CERMP2	UWM115

Weld Metal

- Mixture of copper oxide and aluminum, packaged in individual, moisture resistant plastic cartridges
- Each cartridge is marked with the size
- Cartridges are packaged in a plastic box containing either 10 units per box or 20 units per box
- Each box contains instructions and metal disks; One metal disk is used for each connection
- The plastic box is shrink-wrapped to provide additional moisture protection



Mfg	Part #	Description
Harger	UWM15	15 Gram Shot 20 per Case
Harger	UWM25	25 Gram Shot 20 per Case
Harger	UWM32	32 Gram Shot 10 per Case
Harger	UWM45	45 Gram Shot 20 per Case
Harger	UWM65	65 Gram Shot 20 per Case
Harger	UWM90	90 Gram Shot 10 per Case
Harger	UWM115	115 Gram Shot 10 per Case
Harger	UWM150	150 Gram Shot 10 per Case
Harger	UWM200	200 Gram Shot 10 per Case
Harger	UWM250	250 Gram Shot 10 per Case
Harger	UWM500	500 Gram Shot 10 per Case

Grounding

Flint Igniters

Mold Accessories

- When making a connection, flint igniters are used to ignite the starting material
- Includes MH1 and MH2 handle clamps
- Replacement flints are also available



Mfg	Part #	Description
Harger	FLTIG	Flint Igniter
Harger	FLTIGEXT	Flint Igniter Extension
Harger	RPLFLT	Replacement Flint

Torch Head

Mold Accessories

- Self-igniting torch head is designed to fit 14 or 16 ounce propane cylinders
- Torches are required to remove moisture from the mold and conductors before making the Ultraweld connections

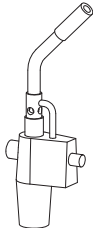

Mfg	Part #	Description
Harger	TRCHD	Self-Igniting Torch Head

Wrap Sleeve

Adapting Molds to Fit Conductors

- Wrap sleeve can be used when welding cables smaller than indicated on mold tag
- When the cable opening in the mold is larger than the cable, copper wrap sleeves are wrapped around the cable until the diameter is about the same size as the mold cable opening

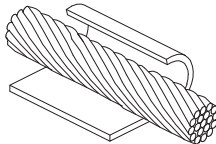

Mfg	Part #	Description
Harger	WRPSLV	Wrap Sleeve, 50 per Box

Ceramic Rebar Packing Material

Adapting Molds to Fit Conductors

- Packing consists of preformed ceramic batting
- Packing is required on all rebar connections to prevent leakage

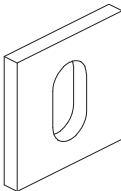

Mfg	Part #	Description
Harger	CERPM1*	Ceramic Rebar Packing Material
Harger	CERPM2*	Ceramic Rebar Packing Material
Harger	CERPM3*	Ceramic Rebar Packing Material

*Refer to rebar mold tables for correct packing material

Mold Sealer

Adapting Molds to Fit Conductors

- Used for sealing slightly worn molds to guard against leakage from large stranded conductors
- Available in convenient 1 lb. package

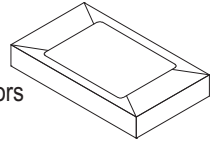

Mfg	Part #	Description
Harger	MLDSLRL	Mold Sealer, 1 lb. Block

Card Cloth Brush

Cable and Work Surface Preparation

- Features short, stiff, metal bristles which are generally preferred for cleaning concentric conductors and bus bars that are not heavily oxidized

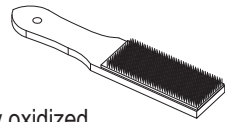

Mfg	Part #	Description
Harger	CCBRSH1	Card Cloth Brush

Cable Cleaning Brush

Cable and Work Surface Preparation

- Ideal for cleaning concentric stranded cable, especially very dirty or oxidized conductors

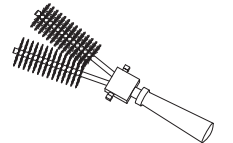

Mfg	Part #	Description
Harger	CCBRSH2	Cable Cleaning Brush
Harger	CCBRSH2R	Replacement Brush

Cold Galvanizing Spray

Cable and Work Surface Preparation

- Used on galvanized steel surfaces to touch up heat-affected areas after welding
- The repair is often cosmetic due to minimal damage that may occur to the galvanized surface



Mfg	Part #	Description
Harger	CGS	Cold Galvanizing Spray, 16 ou. Can

Rasp

Cable and Work Surface Preparation

- Ideal for removing mill scale and rust from steel surfaces

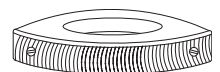

Mfg	Part #	Description
Harger	RASP	Rasp

Mold Cleaning Brushes

Mold Care and Use

- Slag can be removed from molds using a mold cleaning brush
- Especially useful on vertical split molds
- Consistent and proper use of the brush will aid in maintaining or exceeding the average mold life of 50 connections

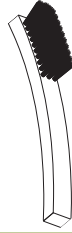

Mfg	Part #	Description
Harger	MCBRSH1	Mold Cleaning Brush - Large
Harger	MCBRSH2	Mold Cleaning Brush - Small

Mold Cleaning Spade

Mold Care and Use

- Slag can be cleaned from the molds by using a mold cleaning spade
- Especially useful on horizontally split molds
- Cleaning spades are specifically designed to fit the mold crucible for a given range of weld metal sizes
- Consistent and proper use of cleaning spades will aid in maintaining or exceeding the average mold life of 50 connections

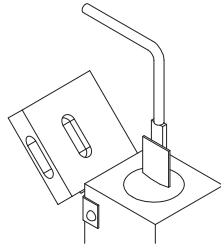

Mfg	Part #	Description
Harger	MCSPD15/65	Mold Cleaning Spade for UWM15 to UWM65
Harger	MCSPD90/500	Mold Cleaning Spade for UWM90 to UWM500

Disks

- Rests on the bottom of the crucible and holds the weld metal powder in place until the reaction occurs
- A new disk is required each time a weld is made
- Disks are included with the weld metal

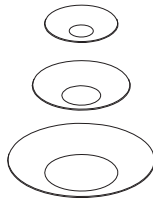

Mfg	Part #	Description
Harger	DISK15/65	Weld Metal Disk - Small
Harger	DISK90/115	Weld Metal Disk - Medium
Harger	DISK150/500	Weld Metal Disk - Large

Disk Kit

- Contains three sizes of steel disks; 60 small, 30 medium and 30 large



Mfg	Part #	Description
Harger	DISKKIT1	Weld Metal Disk Assortment Kit

Mold Handle Clamps

Mold Fastening and Mounting

- Required for all molds
- Some molds are used with specialized frames
- Handle clamps MH1 & MH2 come with flint igniter
- Have a Zinc Ultraseal plated finish

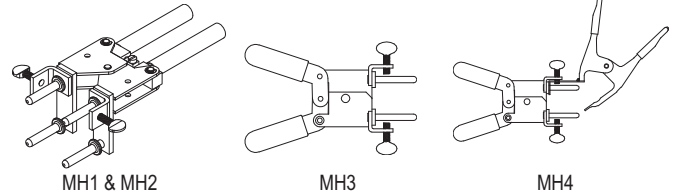

Mfg	Part #	Description
Harger	MH1	Mold Handle Clamp B, E, K, P, Q Mold Series
Harger	MH2	Mold Handle Clamp C, D, F, Z Mold Series
Harger	MH3	Mold Handle Clamp L, M, N Mold Series
Harger	MH4	Mold Handle Clamp R Mold Series

Chain Support Handle Clamps

Mold Fastening and Mounting

- Used to securely hold the mold to a vertical pipe
- Handle clamps CSH1 & CSH2 come with flint igniter
- Includes a 20" length of chain, which fits up to 4" pipes; extra chain length is available

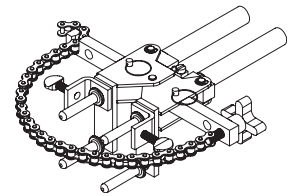

Mfg	Part #	Description
Harger	CSH1	Chain Support Handle Clamp B, E, K Mold Series
Harger	CSH2	Chain Support Handle Clamp C, D, F Mold Series

Chain Support Kits

Mold Fastening and Mounting

- Convert standard mold handle clamps into chain support clamps

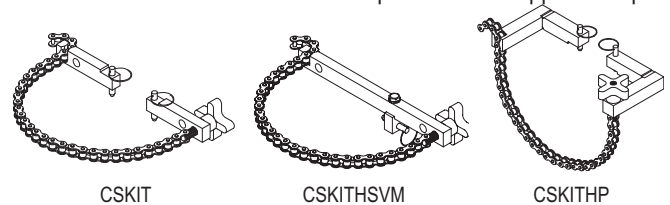

Mfg	Part #	Description
Harger	CSKIT	Chain Support Kit RE, VA, VD, VT, VU Mold Types
Harger	CSKITHSVM	Chain Support Kit Horiz Split VH, RS Mold Types
Harger	CSKITHP	Chain Support Kit Horiz Pipe HB, HD, HT, HU Mold Types

Grounding

Magnetic Support Handle Clamps

Mold Fastening and Mounting

- Allows mold to be securely held in place to steel surfaces
- Handle clamps MSHC1 & MSHC2 come with a flint igniter

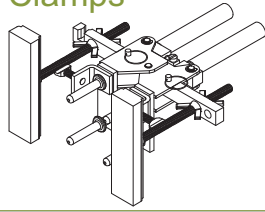

Mfg	Part #	Description
Harger	MSHC1	Magnetic Support Handle Clamp B, E, K Mold Series
Harger	MSHC2	Magnetic Support Handle Clamp C, D, F Mold Series

Magnetic Support Kit

Mold Fastening and Mounting

- Converts the standard mold handle clamp into a magnetic support handle clamp

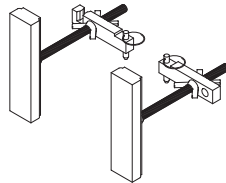

Mfg	Part #	Description
Harger	MSKIT	Magnetic Support Kit

Hold Down Kit

Mold Fastening and Mounting

- Attaches easily to MH1 & MH2 handle clamps for holding mold in place

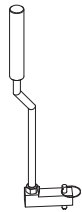

Mfg	Part #	Description
Harger	UMHDKIT	Hold Down Kit for Following Connection Types: HB, HD, HT, HU, RO, & RP

Mounting Beam Clamp

Mold Fastening and Mounting

- Mounts to MH1 & MH2 handle clamps to securely hold mold to a vertical column or angle

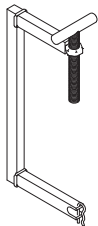

Mfg	Part #	Description
Harger	UMBCLAMP	Mounting Beam Clamp, 7", For Following Connection Types: VA, VD, VH, VR, VL, VT & VU

Mold Handle Clamp Kits

Mold Fastening and Mounting

- Handle clamps MH1 & MH2 come with a flint igniter
- Chain support handle clamp securely holds mold to a vertical pipe
- Magnetic support handle clamp holds mold securely in place when welding to steel surface

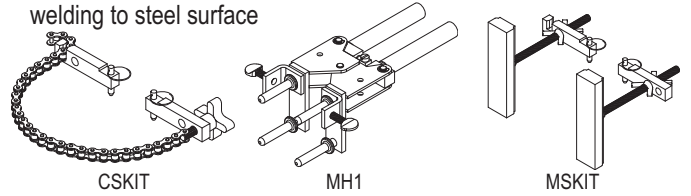

Mfg	Part #	Description
Harger	ULTRAMH1KIT	Mold Handle Clamp Kits B, E, K Mold Series. Kit Includes CSKIT, MH1, MSKIT.
Harger	ULTRAMH2KIT	Mold Handle Clamp Kits C, D, F Mold Series. Kit Includes CSKIT, MH2, MSKIT.

Weld Blanket

Mold Fastening and Mounting

- Made from Thermobest™ material, a Kevlar® blend, that offers heat and abrasion resistance
- Ideal for handling hot molds or keeping a work surface clean from hot slag

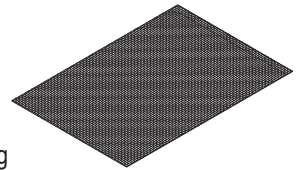

Mfg	Part #	Description
Harger	WELDBKT	Weld Blanket

Toolbox

- Plastic toolbox measures 22" x 9.5" x 9.75" and includes a tray

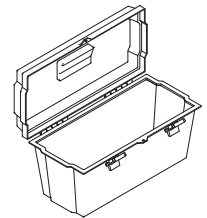

Mfg	Part #	Description
Harger	TOOLBOX	Toolbox, 22" x 9.5" x 9.75"

Copper Clad Steel Ground Rods

Mfg	Part #	Description
Harger	588	5/8" x 8' Copper Clad Steel Ground Rod
Harger	5810	5/8" x 10' Copper Clad Steel Ground Rod
Harger	348	3/4" x 8' Copper Clad Steel Ground Rod
Harger	3410	3/4" x 10' Copper Clad Steel Ground Rod
Harger	3412	3/4" x 12' Copper Clad Steel Ground Rod



CPC Pipe Clamps

- Manufactured from electroplated tinned bronze
- Wider conductor range; #6 through 250 MCM
- Features “quick connect” bi-directional design
- Pressed-in stud ensures a flush mounting surface
- Dual UL listing (UL96 & UL467)
- Suitable for direct burial

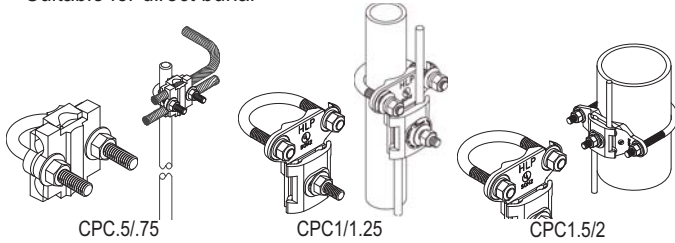

Mfg	Part #	Description
Harger	CPC.5/1.75	CPC U-Bolt Pipe Clamp, 0.5"-0.75" Outside Diameter Leg
Harger	CPC1/1.25	CPC U-Bolt Pipe Clamp, 1"-1.25" Outside Diameter Leg
Harger	CPC1.5/2	CPC U-Bolt Pipe Clamp, 1.5"-2" Outside Diameter Leg

Solid Copper Conductors Solid Single Soft-Drawn Bare Copper

Mfg	Part #	Description
Harger	10	10 Awg Sol Cu Bare
Harger	6	6 Awg Sol Cu Bare
Harger	4	4 Awg Sol Cu Bare
Harger	2	2 Awg Sol Cu Bare

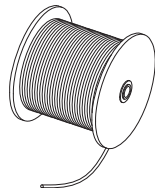

Solid Tinned Copper Conductors Solid Single Soft-Drawn Bare Tinned Copper

Mfg	Part #	Description
Harger	6T	6 Awg Sol Cu Tinned
Harger	4T	4 Awg Sol Cu Tinned
Harger	2T	2 Awg Sol Cu Tinned

Available in 100', 250', and 500' spools

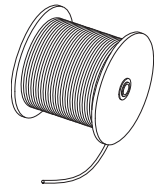

Stranded Copper Conductors Concentric Lay Soft-Drawn Bare Copper

Mfg	Part #	Description
Harger	6-7	#6 Awg 7 Std Cu Bare
Harger	4-7	#4 Awg 7 Std Cu Bare
Harger	2-7	#2 Awg 7 Std Cu Bare
Harger	1/0-19	1/0 Awg 19 Std Cu Bare
Harger	2/0-7	2/0 Awg 7 Std Cu Bare
Harger	2/0-19	2/0 Awg 19 Std Cu Bare
Harger	3/0-19	3/0 Awg 19 Std Cu Bare
Harger	4/0-7	4/0 Awg 7 Std Cu Bare
Harger	4/0-19	4/0 Awg 19 Std Cu Bare

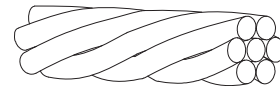

7 Strand Concentric

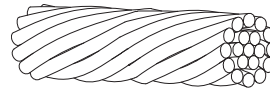

19 Strand Concentric

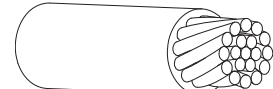

7 Strand Concentric

Stranded Copper Conductors Green Insulated Conductors

Mfg	Part #	Description
Harger	6-7G	6 Awg 7 Std Cu XHHW Green
Harger	6-19G	6 Awg 19 Str THHN Green
Harger	4-7G	4 Awg 7 Std Cu XHHW Green
Harger	4-19G	4 Awg 19 Strand Green
Harger	2-7G	2 Awg 7 Std Cu XHHW Green
Harger	2-19G	2 Awg 19 Strand Cu THHN Green
Harger	1/0-19G	1/0-19 Std Cu THHN Green
Harger	2/0-19G	2/0-19 Std Cu THHN Green
Harger	4/0-19G	4/0-19 Std Cu THHN Green

Ultrafill Earth (Ground) Enhancement Material

- Low resistance carbon-based backfill material which lowers ground system resistance in difficult soil situations
- Ideal for use in rocky soil, sand, gravel, or any other high resistance soil conditions
- May be used in a horizontal trench or grid, or in vertical applications

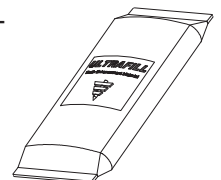

Mfg	Part #	Description
Harger	ULTRAFILL	Earth Ground Enhancement Material, 50 lb. Bag





25G TOWER SYSTEM STANDARD STRUCTURE

Top Sections

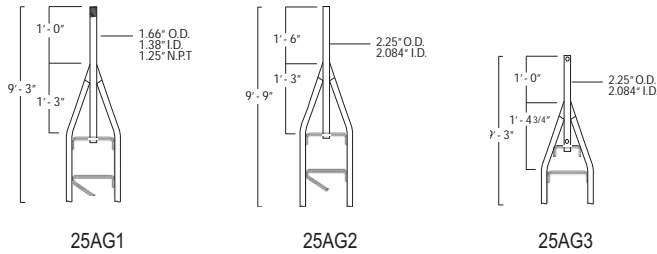

Mfg	Part #	Description
Rohn	25AG1	Short Top Mount with Hardware 9' 3" Overall Length, 1' x 1.66" OD Mast
Rohn	25AG2	Short Top Mount with Hardware 9' 9" Overall Length, 1' 6" x 2.25" OD Mast
Rohn	25AG3	25AG3 Top Section with Hardware 9' 3" Overall Length, 1' x 2.25" OD Mast

Plates and Shelves

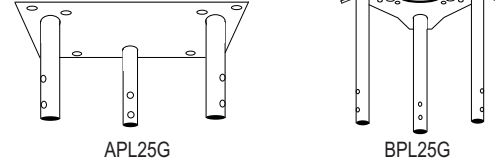

Mfg	Part #	Description
Rohn	APL25G	Accessory Plate / Top Beacon Plate with Hardware
Rohn	BPL25G	Bearing Plate

Guy Brackets and Torque Accessories

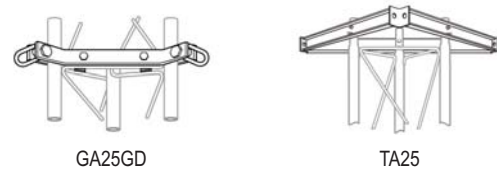

Mfg	Part #	Description
Rohn	GA25GD	Guy Bracket
Rohn	TA25	Torque Arm Stabilizer
Rohn	TB25D	Torque Bars for use with GA25GD Guy Bracket

Mid and Base Stations

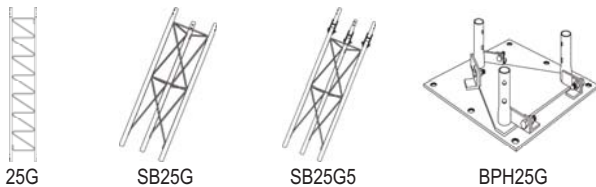

Mfg	Part #	Description
Rohn	25G	10' Section with Hardware
Rohn	SB25G	3' 4" Short Concrete Base
Rohn	SB25G5	5' Short Concrete Base
Rohn	BPH25G	40" Hinged Base

Bases



Mfg	Part #	Description
Rohn	BPC25G	Base Plate
Rohn	BPH25G	Hinged Base Plate
Rohn	FR25G	Flat Roof Mount

Bolts, Nuts and Hardware

Mfg	Part #	Description
Rohn	1/2X12BB	J-bolt with Double Nuts for Base
Rohn	25JBK	Bolt Kit in Tube

Side Arm Brackets



Mfg	Part #	Description
Rohn	UHF25G	Single Level Side Arm

Anti-Climb

Mfg	Part #	Description
Rohn	25ACL3	Anti-Climb Panels

NOTE: Three panels included in kit.



45G TOWER SYSTEM STANDARD STRUCTURE

Top Sections

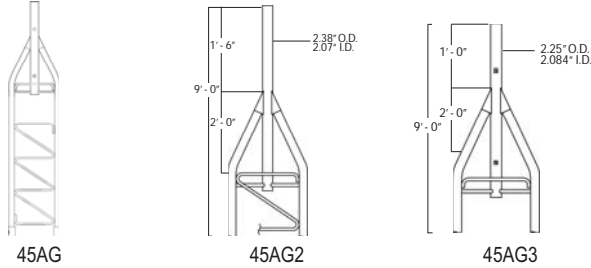

Mfg	Part #	Description
Rohn	45AG	45AG Top Section
Rohn	45AG2	45AG2 Top Section
Rohn	45AG3	45AG3 Top Section

Plates

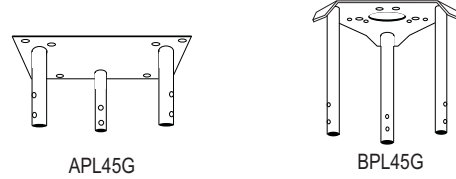

Mfg	Part #	Description
Rohn	APL45G	Beacon Plate with Hardware
Rohn	BPL45G	Bearing Plate

Guy Brackets and Torque Arm Stabilizer

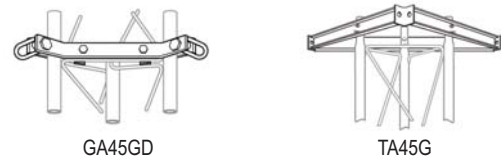

Mfg	Part #	Description
Rohn	GA45GD	Guy Bracket
Rohn	TA45G	Torque Arm Stabilizer

Mid and Base Sections

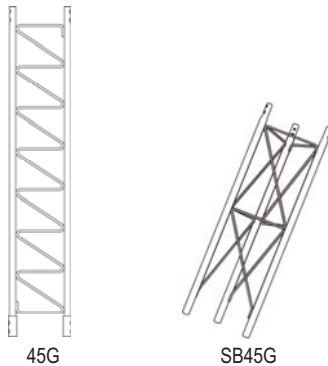

Mfg	Part #	Description
Rohn	45G	10' Section with Hardware
Rohn	SB45G	5' Short Base

Bolts, Nuts and Hardware

Mfg	Part #	Description
Rohn	45JBK	Joint Bolt Kit

Bases

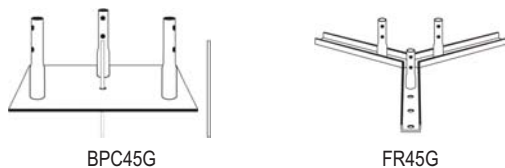

Mfg	Part #	Description
Rohn	BPC45G	Base Plate
Rohn	FR45G	Flat Roof Mount

Anti-Climb

Mfg	Part #	Description
Rohn	455ACL3	Anti-Climb Panels

NOTE: Three panels included in kit.



55G TOWER SYSTEM STANDARD STRUCTURE

Mid and Base Sections

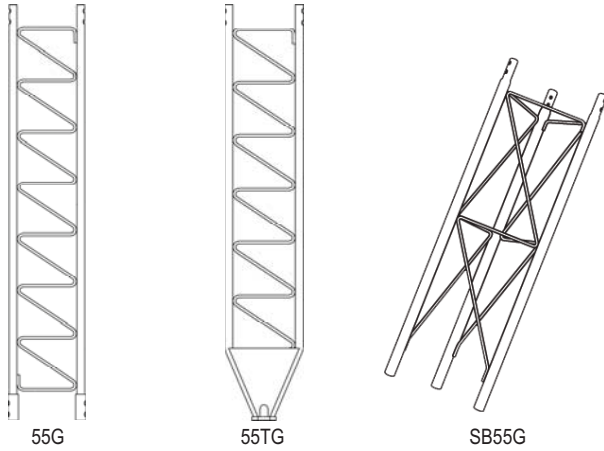

Mfg	Part #	Description
Rohn	55G	10' Section with Hardware
Rohn	SB55G	5' Short Base
Rohn	55TG	Tapered Base

Guy Bracket and Torque Arm Stabilizer

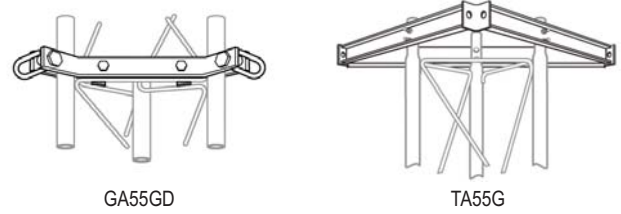

Mfg	Part #	Description
Rohn	GA55GD	Guy Bracket
Rohn	TA55G	Torque Arm Stabilizer

Bolts, Nuts, and Hardware

Mfg	Part #	Description
Rohn	55JBK	Joint Bolt Kit

Bases

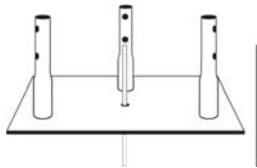

Mfg	Part #	Description
Rohn	BPC55G	Base Plate

Anti-Climb

Mfg	Part #	Description
Rohn	455ACL3	Anti-Climb Panels

NOTE: Three panels included in kit.



Plates

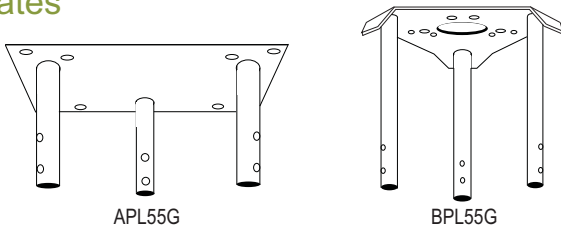

Mfg	Part #	Description
Rohn	APL55G	Beacon Plate with Hardware
Rohn	BPL55G	Bearing Plate

25G, 45G, 55G UNIVERSAL TOWER ACCESSORIES

Safety Package for Turnbuckles

Mfg	Part #	Description
Rohn	TBSAFETY	Safety Package for Turnbuckles

Lighting

Mfg	Part #	Description
Rohn	RA1E-150	Light Kit for 150'
Rohn	OB2	Double Obstruction Light

Guy Wire Ground Kit

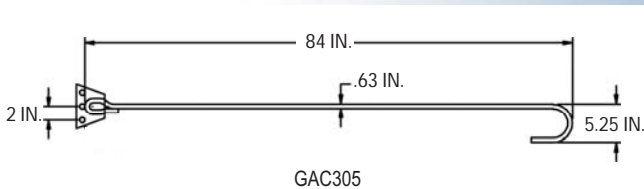

Mfg	Part #	Description
Rohn	GAR303	3-Hole Guy Anchor
Rohn	GAR305	5-Hole Guy Anchor
Rohn	AGKE	Guy Wire Ground Kit

Universal House Bracket

Mfg	Part #	Description
Rohn	HBUTVRO	Universal House Bracket

NOTE: Assembly includes hardware to interface a section to building or house. Does not include anchoring materials to building or house.

Side Arm Brackets

- Double level 3' standoff
- Includes assembly hardware and one 1-1/4" (1.66 OD) x 36" antenna mounting pipe

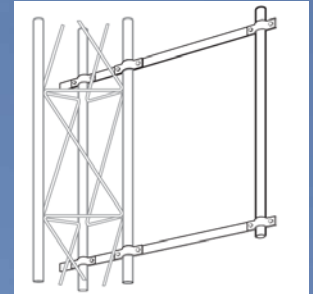

Mfg	Part #	Description
Rohn	SA253UA	Double Level Side Arm

Pier Pin for Concrete Base

Mfg	Part #	Description
Rohn	3/4X12PP	Pier Pin for Concrete Base

Towers

Self-Supported Tower Packages Rohn

Rohn self-supporting towers are produced with unmatched attention to detail. The SSV towers are hot dip galvanized after fabrication to assure years of corrosion free use. Each section of the tower is immersed in molten zinc, inside and out to be completely covered. The hot dip galvanizing protects all points of welding and construction against rust and corrosion.

Each standard catalog tower is a complete kit containing tower base material for concrete, appropriate step bolts, top section, base grounding kits and assembly hardware. All antenna mounts, lights, and safety devices are optional items that can be ordered separately.

Mfg	Part #	Description
Rohn	R-SS100D70	SSV Tower Kit, 70 MPH, NI, 100'
Rohn	R-SS100D90	SSV Tower Kit, 90 MPH, NI, 100'
Rohn	R-SS110D70	SSV Tower Kit, 70 MPH, NI, 110'
Rohn	R-SS110D90	SSV Tower Kit, 90 MPH, NI, 110'
Rohn	R-SS120D70	SSV Tower Kit, 70 MPH, NI, 120'
Rohn	R-SS120D90	SSV Tower Kit, 90 MPH, NI, 120'
Rohn	R-SS130D70	SSV Tower Kit, 70 MPH, NI, 130'
Rohn	R-SS130D90	SSV Tower Kit, 90 MPH, NI, 130'
Rohn	R-SS140D70	SSV Tower Kit, 70 MPH, NI, 140'
Rohn	R-SS140D90	SSV Tower Kit, 90 MPH, NI, 140'
Rohn	R-SS150D70	SSV Tower Kit, 70 MPH, NI, 150'
Rohn	R-SS150D90	SSV Tower Kit, 90 MPH, NI, 150'
Rohn	R-SS160D70	SSV Tower Kit, 70 MPH, NI, 160'
Rohn	R-SS160D90	SSV Tower Kit, 90 MPH, NI, 160'
Rohn	R-SS170D70	SSV Tower Kit, 70 MPH, NI, 170'
Rohn	R-SS170D90	SSV Tower Kit, 90 MPH, NI, 170'
Rohn	R-SS180D70	SSV Tower Kit, 70 MPH, NI, 180'
Rohn	R-SS180D90	SSV Tower Kit, 90 MPH, NI, 180'
Rohn	R-SS190D70	SSV Tower Kit, 70 MPH, NI, 190'
Rohn	R-SS190D90	SSV Tower Kit, 90 MPH, NI, 190'

Each tower application is unique; factors like desired loading with equipment, wind speed for the area, soil conditions, etc all play a part in proper selection of a tower. These towers are "catalog" products that may or may not fill the need for your specific application, but do provide a good starting point for discussion.

Please contact Primus to discuss your exact requirements so we can help you in selecting the right tower for your project. Call us today at (800) 435-1636.



Self-Supported Tower Packages *Light and Heavy Duty*

Complete Light Duty and Heavy Duty Self-Supported Tower Packages, 40' to 120' AGL. These towers are designed to perform in allowable wind exposures from 70 mph to 120 mph.

Features:

- Designed to ANSI/TIA/EIA-222-F
- Hot dip galvanized steel to ASTM-A123
- Constructed of 50 KSI steel throughout
- Base sub-structure included with each tower
- Galvanized connection hardware included



Heavy Duty Model
HD-60

Mfg	Part #	Description
-----	--------	-------------

Light Duty Models, 40' to 90'

AN Wireless	LD-40	40' Self-Supported, Light Duty Tower Package
AN Wireless	LD-50	50' Self-Supported, Light Duty Tower Package
AN Wireless	LD-60	60' Self-Supported, Light Duty Tower Package
AN Wireless	LD-70	70' Self-Supported, Light Duty Tower Package
AN Wireless	LD-80	80' Self-Supported, Light Duty Tower Package
AN Wireless	LD-90	90' Self-Supported, Light Duty Tower Package

Heavy Duty Models, 40' to 120'

AN Wireless	HD-40	40' Self-Supported, Heavy Duty Tower Package
AN Wireless	HD-50	50' Self-Supported, Heavy Duty Tower Package
AN Wireless	HD-60	60' Self-Supported, Heavy Duty Tower Package
AN Wireless	HD-70	70' Self-Supported, Heavy Duty Tower Package
AN Wireless	HD-80	80' Self-Supported, Heavy Duty Tower Package
AN Wireless	HD-90	90' Self-Supported, Heavy Duty Tower Package
AN Wireless	HD-100	100' Self-Supported, Heavy Duty Tower Package
AN Wireless	HD-110	110' Self-Supported, Heavy Duty Tower Package
AN Wireless	HD-120	120' Self-Supported, Heavy Duty Tower Package



Heavy Duty Model
HD-100



TWR LIGHTING

Wind Turbine Complete System Lighting

- One piece to mount, maintain and inventory
- Comprehensive 5-year warranty
- Single source design and manufacturing
- Internal flashing circuit
- Internal GPS synchronization circuitry
- Integrated photocell
- Monitoring and alarm contact provided
- Regulated power supply to consistently provide 2000 candela photometric output
- Weighs only 33 lbs
- Reduced freight costs

Mfg	Part #	Description
<i>Wind Turbine Complete System Lighting</i>		
TWR	WT2LEDG	L350-864G Orga Wind Turbine Lighting System. Medium Intensity Red Synchronized Flashing LED Obstruction Light.

Replacement Parts for WT2LEDG - L350-864G (Red LED with Internal GPS)

TWR	15S99111	L350 Photocell
TWR	42T90220	L350 Base
TWR	42T90350	L350 Lens
TWR	42E35966	L350-864 Complete LED Beacon
TWR	33E70200	GPS Receiver

Replacement Parts for WT2LEDG - L350-864 (Red LED with no Internal GPS)

TWR	15S99111	L350 Photocell
TWR	42T90220	L350 Base
TWR	42T90350	L350 Lens
TWR	42E35905	L350-864 Complete LED Beacon

Mounts for Wind Turbines are available at an additional cost

TWR LIGHTING

MET Tower System Lighting

Red LED System for Nighttime Marking

Red LED System for Nighttime Marking

- Operates during nighttime hours
- Produces 2,000 Candela
- Requires tower to be painted
- Will be synchronized with the wind farm
- Consists of the following:
 - Orga L350-864G LED Beacon (35 Watts)
 - Two TWR 6LED Sidelights (16 Watts / 8 each)
 - Photocell controller
 - Installation hardware

Mfg	Part #	Description
<i>Complete System for Nighttime Marking</i>		
TWR	A1METKIT	Red LED System for MET Tower for Night-time Marking
<i>Replacement Parts for A1METKIT - L303-864</i>		
TWR	42S70021	Single Internal
TWR	42T90031	Flashtube
TWR	42T90305	Clear Lens
TWR	15B90230	Main Power Switch
TWR	42T90220	Base
TWR	42E90864	L303-864 Complete Flash Head
TWR	33E70200	GPS Receiver

MET Tower System Lighting

Dual Strobe System for Daytime and Nighttime Marking

Dual Strobe System for Daytime (white) and Nighttime (Red) Marking

- Recommended for urban populated areas
- Operates 24 hours a day
- Produces 20,000 Candela during daytime hours and 2,000 Candela during nighttime operation
- Does not require tower to be painted
- Will not be synchronized with the wind farm
- Consists of the following:
 - Orga L303-864/865 Dual Strobe System (100 Watts)
 - Two TWR 6LED Sidelights (16 Watts / 8 each)
 - Photocell controller
 - Installation hardware

Mfg	Part #	Description
<i>Dual Strobe System for Daytime and Nighttime Marking</i>		
TWR	AEMETKIT	Dual Strobe System for Daytime (white) and Nighttime (Red) Marking
<i>Replacement Parts for E1METKIT - L303-864 (Red Strobe)</i>		
TWR	42T70120	Dual Internal
TWR	42T90031	Flashtube
TWR	42T90300	Clear Lens
TWR	15B90230	Main Power Switch
TWR	42T90220	Base
TWR	42E90866	L303-864/865 Complete Flash Head
TWR	33E70200	GPS Receiver
<i>Replacement Parts for E1METKIT - L303-865 (White Strobe)</i>		
TWR	42S70021	Internal
TWR	42T90031	Flashtube
TWR	42T90300	Clear Lens
TWR	15B90230	Main Power Switch
TWR	42T90220	Base
TWR	42E90865	L303-865 Complete Flash Head
TWR	33E70200	GPS Receiver

FLASH TECHNOLOGY

MET Tower System Lighting

Medium Intensity Obstruction Lighting System
System Solution for 150' to 350'

- Includes everything for a MET Tower Aviation Obstruction Lighting System
- FAA Compliant, ETL Certified
- Perfect solution when used with solar panel option
- Can be installed at any remote location where a typical power source is not available
- Consists of the following:
 - One L864 LED
 - Two L810 LED
 - One FTC 2201

Mfg	Part #	Description
<i>Complete System for 150' to 350'</i>		
Flash Technology	FAA-A1	System Solution for a MET Tower Aviation Obstruction Lighting, 150' to 350'
<i>Replacement Parts for FAA-A1</i>		
Flash Technology	L864	L864 Red Beacon
Flash Technology	L810	L810 LED
Flash Technology	2480001	4800 Timing Board
Flash Technology	F5991890	Power Cable
Flash Technology	1855001	Photocell

L864 Beacon Details

- Modular design for simple replacement of light engine
- Uses 90% less energy than 300 mm incandescent fixtures
- Mounts onto existing bolt hole patterns
- 5-year performance warranty

L810 Steady Burning LED Details

- High Flux LED technology
- Low Power consumption, 6.5 watts
- Threaded 1" or 3/4" hub for flexible mounting
- 5-year performance warranty

FTC 2201 Red Light Controller Details

- Low power consumption, 1 watt
- Alarm output
- Manual "ON-Auto-OFF" switch
- Lockable weatherproof enclosure

MET Tower System Lighting

Medium Intensity Obstruction Lighting System
System Solution for Less than 150'

- System includes two steady burning LED side markers
- FAA Compliant, ETL Certified
- Low power consumption
- Adjustable flashing (20 - 40 fpm)
- Consists of the following:
 - Two L810 LED
 - One FTC 2201

Mfg	Part #	Description
<i>Complete System for Less than 150'</i>		
Flash Technology	FAA-A0	System Solution for a MET Tower Aviation Obstruction Lighting, Less than 150'
<i>Replacement Parts for FAA-A0</i>		
Flash Technology	L810	L810 LED
Flash Technology	2480001	4800 Timing Board
Flash Technology	F5991890	Power Cable
Flash Technology	1855001	Photocell



Wireless Modems

Wireless Radio Products by Esteem Wireless Modems

The Esteem models 195Ed and 195Eg are two excellent choices for wireless networks that cover a large geographical area. The 195Ed product operates in the unlicensed 900MHz frequency, delivering 1 to 54 Mbps with up to an 11 mile range, while the 195Eg radio product is an 802.11g/b protocol compatible product operating in the 2.4GHz unlicensed frequency with a nominal 5 to 7 mile range.

Both products have an outdoor case design, so they can be mounted either indoor or outdoor in harsh environments. Simple pole mounting will save installation time and expense. These radio products can be used to transmit important monitoring information about your network in areas where wireless transmission is the most feasible solution.

195Ed Wireless Modem

- 902-928MHz (unlicensed)
- 1 to 54 Mbps RF Data Rate
- 11 mile range (@ 11 Mbps)
- MESHing, Self Healing Network Architecture
- 128-bit AES Encryption
- Dual Antenna Input/Outputs

195Eg Wireless Modem

- 2.4GHz (unlicensed)
- 1 to 54 Mbps RF Data Rate
- 5 to 7 mile nominal range
- MESHing, Self Healing Network Architecture
- 128-bit AES Encryption
- Dual Antenna Input/Outputs

Mfg	Part #	Description
Esteem Wireless	195ED	195Ed Wireless Modem
Esteem Wireless	195EG	195Eg Wireless Modem

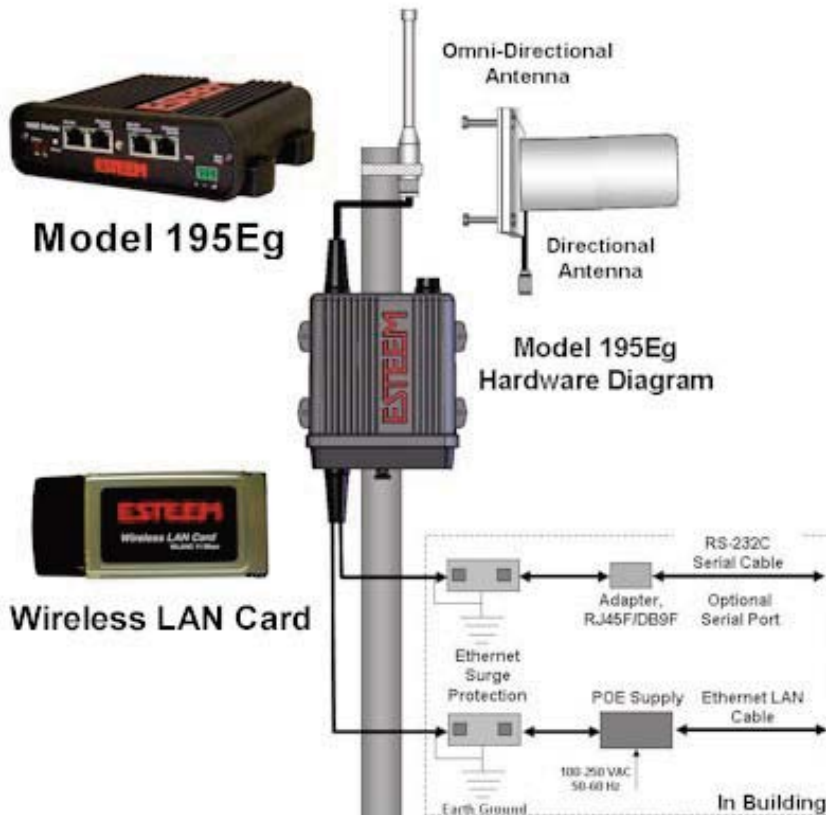

Roxtec

Roxtec cable and pipe seals in windpower infrastructure

Roxtec develops, manufacture and sell complete sealing solutions for cables and pipes. Their pioneering modular-based seals are the base for our rapid and sustainable growth, but the positive trend is first of all built on committed people, strong values, and a clear customer focus.

With the Roxtec cable sealing system, you have one standardized safety solution for long-term operational reliability for every application in the wind power industry. Our system covers all your protection needs – and ensures a good return on investment.

All in one solution

Operators can standardize international projects and count on fast roll-out and global support. Designers can deliver wise, readily available safety solutions that protect against extra costs and warranty claims. And subcontractors can perform their tasks in a quick, smart, clean and easy way, ensuring quality throughout service and maintenance agreements.

Reliability is crucial

Every Roxtec component is developed to ensure maximum uptime. Their seals are designed for applications from nacelle to foundation and transmission substations – in on-shore as well as offshore wind farms. The seals are tested and certified to protect your investment against water, fire, electro-magnetic disturbance, dust, vibrations, and rodents.

Speed and safety

To stay competitive, you must be able to act quickly. Thanks to the flexibility and the cable-friendly rubber modules of the Roxtec system, cables of different sizes, even with lugs, are securely routed, sealed and fixed. This ensures fast installation and a vibration protection that extends the lifetime of the cables.

Primus has all your Roxtec replacement parts and complete systems for your wind energy infrastructure needs. Please contact us at 800-435-1636 for questions and to place orders.

Typical applications for Roxtec:

- Submarine cable inlets for offshore wind turbines
- Substations
- Technical shelters
- Cable inlet rooms
- Control cabinets
- Converter stations
- Offshore transformer platforms
- Transits for technical shelters and transformer stations.
- Transits

Technical competences:

- Firestop
- Watertightness
- Gastightness
- EMC Potential Equalisation
- Cable retention
- Reduction of vibration



Lubricants

PYROSHIELD® Open Gear Lubricant

Excellent in applications subjected to high load, heavy shock and very high temperatures including those where gears are subjected to high contact pressures which may result in point of contact temperatures of 620°F (327°C) and above. Formulated with a high viscosity 100% synthetic base oil, a non-melting thickening system and Lubrication Engineers® (LE) proprietary heat stable additives.

Other Features and Benefits:

- Exceptional load-carrying capacity
- Outstanding adhesiveness and water resistance
- Ease of application at various temperatures

Simalube® - Automatic Lubricator

- Gain control over the Lubrication Process
- Streamline and automate lubrication tasks
- Increase worker safety
- Dispense lubricants more intelligently
- Reduce friction, wear, and energy consumption

MONOLEC® Multiplex Lubricant

MONOLEC Multiplex Lubricant is a high quality, lithium complex grease that meets the requirements of the NLGI GC-LB specification. This wear-reducing lubricant creates a singular molecular lubricating film on the metal surface, vastly increasing film strength without affecting tolerances which allows opposing surfaces to slide by one another, greatly reducing friction, heat and wear.

Other Features and Benefits:

- Versatile product - suitable for all types of bearings
- Broad operating temperature range of 40°F to 400°F (-40°C to 204°C)
- Excellent load carrying ability

SYNPAG® Gear Lubricants

Family of synthetic Polyalkylene Glycol (PAG) based great lubricants known for their extreme pressure characteristics and ability to prevent micropitting. Outstanding lubricants for all types of industrial gears, and plain and anti-friction bearings under extreme severe service conditions; especially beneficial for the lubrication of worm gears.

Other Features and Benefits:

- Excellent corrosion prevention properties
- Extremely high viscosity index results in wide operating temperatures
- Contains DUOLEC™, LE's proprietary dual acting wear-reducing and extreme pressure additive

Mfg	Part #	Description	Package Size
<i>Lubricants</i>			
Lubrication Engineers, Inc.	5182	PYROSHIELD® Open Gear Lube	Case of 50 Tubes
Lubrication Engineers, Inc.	4622	Monolec Multiplex Lube in a Simalube Single Point Lubricant	Case of 10 Units with 250 ml of Lube in each
Lubrication Engineers, Inc.	9705	SYNPAG™ Gear Lubricant ISO 220	55 Gallon Drum
Lubrication Engineers, Inc.	9707	SYNPAG™ Gear Lubricant ISO 460	55 Gallon Drum
<i>Simalube Automatic Lubricator - Dispensing Quantity: 0.08 to 8.3 ml/day</i>			
Lubrication Engineers, Inc.	30ml	Simalube Automatic Lubricator, Size 30 ml	
Lubrication Engineers, Inc.	60ml	Simalube Automatic Lubricator, Size 60 ml Ideal for small amounts of space.	
Lubrication Engineers, Inc.	125ml	Simalube Automatic Lubricator, Size 125 ml	
Lubrication Engineers, Inc.	250ml	Simalube Automatic Lubricator, Size 250 ml Most commonly used.	

Wind Meters

Wind Meters

Features:

- Hand-held devices about the size of a mobile phone
- Tough, immune to elements, and float in water
- See individual meters for difference in features

Mfg	Part #	Description
Kestrel Meters	K1000	Kestrel 1000 Pocket Wind Meter
Kestrel Meters	K2000	Kestrel 2000 Pocket Thermo Wind Meter
Kestrel Meters	K2500	Kestrel 2500 Pocket Weather Meter
Kestrel Meters	K3000	Kestrel 3000 Pocket Weather Meter
Kestrel Meters	K3500	Kestrel 3500 Pocket Weather Meter
Kestrel Meters	K4000	Kestrel 4000 Pocket Weather Tracker
Kestrel Meters	K4100	Kestrel 4100 Pocket Air Flow Tracker
Kestrel Meters	K4200	Kestrel 4200 Pocket Air Flow Tracker
Kestrel Meters	K4500	Kestrel 4500 Pocket Weather Meter

	kestrel 1000 Pocket Wind Meter	kestrel 2000 Pocket Thermo Wind Meter	kestrel 2500 Pocket Weather Meter	kestrel 3000 Pocket Weather Meter	kestrel 3500 Pocket Weather Meter	kestrel 4000 Pocket Weather Tracker	kestrel 4100 Pocket Air Flow Tracker	kestrel 4200 Pocket Air Flow Tracker	kestrel 4500 Pocket Weather Meter
Wind Speed	•	•	•	•	•	•	•	•	•
Max Wind Speed	•	•	•	•	•	•	•	•	•
Average Wind Speed	•	•	•	•	•	•	•	•	•
Air Flow							•	•	
Temperature		•	•	•	•	•	•	•	•
Wind Chill		•	•	•	•	•	•	•	•
Backlit Display		•	•	•	•	•	•	•	•
Relative Humidity				•	•	•	•	•	•
Humidity Ratio								•	
Heat Stress Index				•	•	•	•	•	•
Dew Point				•	•	•	•	•	•
Wet Bulb					•	•		•	•
Altitude			•		•	•		•	•
Digital Compass									•
Wind Direction									•
Crosswind									•
Heatwind/Tailwind									•
Density Altitude						•		•	•
Barometric Pressure/Trend			•		•	•		•	•
Clock			•		•	•	•	•	•
Computer Interface						•	•	•	•
Data Storage						•	•	•	•
Hvac Functionality							•	•	
Night Vision			•		•	•			•

Lad-Saf® Flexible Cable Ladder Safety System

DBI Sala

Features:

- Shock-absorbing design uses an elastomeric impact attenuator to reduce the forces imposed on the ladder structure
- Swiveling Lad-Saf® sleeve prevents falls by locking onto the cable; it's easily attached or removed anywhere along the cable and automatically follows a climb or descend
- Easily install with standard wrenches
- System is galvanized for a maintenance-free life

Tuf-Tug® Climb Assist System

Features:

- Assists climb efforts up and down
- Reduces worker stress and fatigue
- Increases individuals' climb efficiency
- Adapts to Tuf-Tug cable safe climb
- Proudly made in the USA

tractelift® Climbing Aid

Tractel Inc.

Features:

- Climbing aid for vertical ladders
- Relieves 88 lbs. of weight
- Saves climber's strength
- Reduces climbing time
- Improves operational safety

Primus has all your product needs including complete vertical systems for your wind energy applications. Please note that these systems are specific to your site requirements. Please contact us at 800-435-1636 to let us help you find the system that best meets your individual needs.



Pictured: DBI Sala Lad-Saf System

Index by Part Number

part number, page number

1/0-19, 31	19935, 16	42T90031, 39	8900292, 16	CGS, 28
1/0-19G, 31	2, 31	42T90220, 38, 39	8900293, 16	CPC.5/75, 31
1/2X12BB, 32	2-19G, 31	42T90300, 39	8900294, 16	CPC1.5/2, 31
10, 31	2-7, 31	42T90305, 39	8902004, 16	CPC1/1.25, 31
10008175, 18	2-7G, 31	42T90350, 38	8902206, 16	CSH1, 29
10012855, 18	2/0-19, 31	44402, 4	9501403, 5	CSH2, 29
10017931, 15	2/0-19G, 31	44404, 4	9705, 43	CSKIT, 29
1003000, 14	2/0-7, 31	455ACL3, 33, 34	9707, 43	CSKITHP, 29
10041615, 6	2000112, 13	45AG, 33	A11(Color)1, 17	CSKITHSVM, 29
10041818, 18	2000113, 13	45AG2, 33	A16(Color)1, 17	CT2/02/0, 20
10041819, 18	2000114, 13	45AG3, 33	A1METKIT, 39	CT22/0, 20
10041820, 18	2101630, 14	45G, 33	AD111A, 15	CT2222, 20
10041823, 18	2104519, 14	45JBK, 33	AE542AW2, 8	CT2222LD, 20
10043033, 6	21402, 15	4622, 43	AEMETKIT, 39	CT2248, 20
10070917, 18	21403, 15	475358, 17	AGKE, 35	CT2248LD, 20
10070918, 18	21803, 15	475366, 17	AN112A, 14	CT24/0, 20
10070919, 18	21915, 15	475369, 17	APL25G, 32	CT4/02/0, 20
10070920, 18	21920, 15	475370, 17	APL45G, 33	CT4/04/0, 20
10070921, 18	21930, 15	475371, 17	APL55G, 34	CT4446, 20
10077571, 6	21950, 15	4T, 31	B16, 10	CT4666, 20
10087220, 17	21965, 15	5000335, 10	B17L, 10	CT4666LD, 20
10088259, 8	2480001, 40	5000338, 10	B17R, 10	D20L, 10
10088260, 8	250ml, 43	505063, 9	B71, 10	D20S, 10
10089207, 13	25ACL3, 32	506203, 15	BE121.51/0B, 25	DISK15/65, 29
10089209, 13	25AG1, 32	506205, 15	BE121.52/0B, 25	DISK150/500, 29
1107775, 5	25AG2, 32	506615, 15	BE121.53/0B, 25	DISK90/115, 29
1107776, 5	25AG3, 32	506632, 14	BE121.54/0B, 25	DISKKIT1, 29
1107777, 5	25G, 32	5182, 43	BE141.51/0B, 25	E02P, 17
1107778, 5	25JBK, 32	5516, 11	BE141.52/0B, 25	E47 PB, 17
1107800, 5	26773, 14	55G, 34	BE141.52B, 25	E48 PB, 17
1107803, 5	26793, 14	55JBK, 34	BE141.52SB, 25	E66W1, 17
1107806, 5	29886, 14	55TG, 34	BE141.53/0B, 25	E72AC, 17
1107807, 5	2T, 31	5810, 30	BE141.54/0B, 25	E81 PHZ, 17
1108650, 5	3/0-19, 31	588, 30	BE141.56B, 25	E86900, 17
1108651, 5	3/4X12PP, 35	5900550, 14	BE381.51/0B, 25	F5991890, 40
1108652, 5	30ml, 43	6, 31	BE381.52/0B, 25	FAA-A0, 40
1108657, 5	3100, 9	6-19G, 31	BE381.53/0B, 25	FAA-A1, 40
1110300, 5	3101000, 15	6-7, 31	BE381.54/0B, 25	FLTIG, 28
1110301, 5	3101001, 15	6-7G, 31	BPC25G, 32	FLTIGEXT, 28
1110302, 5	3102, 9	60ml, 43	BPC45G, 33	FR25G, 32
1110303, 5	3102000, 15	6116502, 10	BPC55G, 34	FR45G, 33
11150510, 18	3102003, 15	6116540, 10	BPH25G, 32	GA25GD, 32
11150511, 18	3103108, 15	62432, 4	BPL25G, 32	GA45GD, 33
1232354, 9	3103208, 15	62434, 4	BPL45G, 33	GA55GD, 34
1240416, 8	33E70200, 38, 39	62451, 4	BPL55G, 34	GAR303, 35
1244406, 8	3410, 30	62452, 4	BS1/0B, 21	GAR305, 35
1244409, 8	3412, 30	62453, 4	BS1L, 21	GBU14412M, 21
125ml, 43	34416, 9	62454, 4	BS2/0B, 21	GBU14420M, 21
15B90230, 39	34496, 9	62455, 4	BS2L, 21	GBU14424M, 21
15S99111, 38	348, 30	62456, 4	BS2SL, 21	GD121/0B, 23
17426, 13	3504430, 15	63673, 14	BS3/0B, 21	GD121B, 23
17435, 13	35478, 8	63786, 14	BS3L, 21	GD122/0B, 23
17443, 13	35598, 8	6T, 31	BS4/0B, 21	GD122B, 23
17450, 13	35678, 8	710, 18	BS4L, 21	GD123/0B, 23
17451, 13	36897, 8	74301, 4	C42 100, 14	GD124/0B, 23
1855001, 40	4, 31	74302, 4	C42 150, 14	GD124L, 23
19100, 10	4-19G, 31	74303, 4	C42 200, 14	GD341B, 23
19200, 10	4-7, 31	74304, 4	C42 F, 14	GD342B, 23
19401, 10	4-7G, 31	75301, 4	C42 V, 14	GD342SB, 23
195ED, 41	4/0-19, 31	75302, 4	C49, 9	GD344L, 23
195EG, 41	4/0-19G, 31	75303, 4	C71000, 6	GD581/0B, 23
19700, 10	4/0-7, 31	75404, 4	C710FN, 6	GD581B, 23
19701, 10	42E35905, 38	81391, 17	C71CFO 1, 6	GD582/0B, 23
19905, 16	42E35966, 38	8252Z, 18	CCBRSH1, 28	GD582B, 23
19910, 16	42E90864, 39	84221, 12	CCBRSH2, 28	GD582SB, 23
19915, 16	42E90865, 39	84231, 12	CCBRSH2R, 28	GD583/0B, 23
19920, 16	42E90866, 39	84303, 12	CERPM1, 28	GD584/0B, 23
19925, 16	42S70021, 39	84521, 12	CERPM2, 28	GD584L, 23
19930, 16	42T70120, 39	88128, 17	CERPM3, 28	GECLB1/0, 20

part number, page number

GECLB1/02C, 20	HD2A, 24	NB58600, 11	RB44021, 12	RO53/0Q, 26
GECLB1/02D, 20	HD2SA, 24	OB2, 35	RB44023, 12	RO54/0Q, 26
GECLB2/0, 20	HD3/0B, 24	P05, 16	RB44024, 12	RO54B, 26
GECLB2/02C, 20	HD4/0B, 24	P07, 16	RB44028, 12	RO56B, 26
GECLB2/02D, 20	HD4A, 24	P50, 16	RB44029, 12	RO58SB, 26
GECLB22B, 20	HD6A, 24	P51, 16	RB44040, 12	RO6L1/0B, 26
GECLB22BC, 20	HD6SA, 24	P59, 16	RB44041, 12	RO6L1B, 26
GECLB22BCS, 10	HG32021, 17	P60, 16	RB44042, 12	RO6L2/0B, 26
GECLB22BS, 20	HG32023, 17	P63 L, 13	RB44043, 12	RO6L2B, 26
GECLB22C, 20	HG32024, 17	P63 M, 13	RB44058, 12	RO6L3/0B, 26
GECLB22CS, 20	HL33011, 17	P63 S, 13	RB6GA4/OX15, 21	RO6L4/0B, 26
GECLB2502D, 10	HL33012, 17	P65, 16	RC48010, 11	RO6L4B, 26
GECLB4/0, 20	HL33013, 17	P66, 16	RC48021, 11	RO6L6B, 26
GECLB4/02C, 20	HL33014, 17	PB11B, 21	RC48022, 11	Roxtec, 42
GECLB4/02D, 20	HL33060, 17	PB12B, 21	RC48023, 11	RP31/0B, 27
GECLB5002D, 10	HL33068, 17	PB14B, 21	RC48026, 11	RP31B, 27
GECLB6, 20	K1000, 44	PB16B, 21	RC48027, 11	RP32/0B, 27
GECLB62BC, 20	K2000, 44	PB16SB, 21	RC48032, 11	RP32B, 27
GECLB62C, 20	K2500, 44	PB18SB, 21	RC48033, 11	RP33/0B, 27
GECLB63/8, 20	K3000, 44	PB22B, 21	RC48033, 11	RP34/0B, 27
GECLB7502D, 10	K3500, 44	PB24B, 21	RE31/0B, 25	RP34B, 27
GL22302, 18	K4000, 44	PB26B, 21	RE32/0B, 25	RP36B, 27
GL22303, 18	K4100, 44	PB26SB, 21	RE32B, 25	RP38SB, 27
GL22304, 18	K4200, 44	PB28SB, 21	RE33/0B, 25	RP41/0B, 27
GL22305, 18	K4500, 44	PB2S2SB, 21	RE34/0B, 25	RP42/0B, 27
GL22306, 18	K53, 18	PB44B, 21	RE34B, 25	RP43/0B, 27
GO121/0B, 23	KT36113, 16	PB46B, 21	RE41/0B, 25	RP44/0B, 27
GO121B, 23	KT36114, 16	PB46SB, 21	RE41B, 25	RP4L1A, 27
GO122/0B, 23	KT36115, 16	PB48SB, 21	RE42/0B, 25	RP4L2A, 27
GO122B, 23	KT36120, 16	PS44M, 22	RE42B, 25	RP4L4A, 27
GO122SB, 23	KT36121, 16	PS4S4SM, 22	RE43/0B, 25	RP4L6A, 27
GO123/0B, 23	L50 100, 9	PS66L, 22	RE44/0B, 25	RP51/0B, 27
GO124/0B, 23	L50 150, 9	PS6S6SL, 22	RE44B, 25	RP52/0B, 27
GO124L, 23	L50 200, 9	PS88L, 22	RE51/0B, 25	RP53/0B, 27
GO341/0B, 23	L50 60, 9	PS8S8SL, 22	RE51B, 25	RP54/0B, 27
GO341B, 23	L52 2, 9	PT2S2SB, 22	RE52/0B, 25	RP6L1/0B, 27
GO342/0B, 23	L52 2H, 9	PT8S8SB, 22	RE52B, 25	RP6L2/0B, 27
GO342B, 23	L52 3, 9	R-SS100D70, 36	RE53/0B, 25	RP6L3/0B, 27
GO342SB, 23	L52 3H, 9	R-SS100D90, 36	RE54/0B, 25	RP6L4/0B, 27
GO343/0B, 23	L52 3MG, 9	R-SS110D70, 36	RE54B, 25	RPLFLT, 28
GO344/0B, 23	L52 5, 9	R-SS110D90, 36	RE61/0B, 25	RR110OB046E, 11
GO344M, 23	L57, 8	R-SS120D70, 36	RE61B, 25	RR110OB061E, 11
GO581/0B, 23	L70150 YM, 8	R-SS120D90, 36	RE62/0B, 25	RR110OB092E, 11
GO581B, 23	L810, 40	R-SS130D70, 36	RE62B, 25	RR110OB183E, 11
GO582/0B, 23	L864, 40	R-SS130D90, 36	RE63/0B, 25	RR110RB046E, 11
GO582B, 23	Lad-Saf, 45	R-SS140D70, 36	RE64/0B, 25	RR110RB061E, 11
GO582SB, 23	LD-40, 37	R-SS140D90, 36	RE64B, 25	RR110RB092E, 11
GO583/0B, 23	LD-50, 37	R-SS150D70, 36	RO31/0Q, 26	RR110RB183E, 11
GO584/0B, 23	LD-60, 37	R-SS150D90, 36	RO31B, 26	RR110WB046E, 11
GO584L, 23	LD-70, 37	R-SS160D70, 36	RO32/0Q, 26	RR110WB061E, 11
HBUTVRO, 35	LD-80, 37	R-SS160D90, 36	RO32B, 26	RR110WB092E, 11
HD-100, 37	LD-90, 37	R-SS170D70, 36	RO33/0Q, 26	RR110WB183E, 11
HD-110, 37	MCBRSH1, 29	R-SS170D90, 36	RO34/0Q, 26	RR110YB046E, 11
HD-120, 37	MCBRSH2, 29	R-SS180D70, 36	RO34B, 26	RR110YB061E, 11
HD-40, 37	MCSPD15/65, 29	R-SS180D90, 36	RO36B, 26	RR110YB092E, 11
HD-50, 37	MCSPD90/500, 29	R-SS190D70, 36	RO38SB, 26	RR110YB183E, 11
HD-60, 37	MCT, 21	R-SS190D90, 36	RO41/0Q, 26	RT1/01/0B, 22
HD-70, 37	MCT81/0M, 21	R11183R, 11	RO41Q, 26	RT1/01B, 22
HD-80, 37	MH1, 29	R12183Y, 11	RO42/0Q, 26	RT1/02B, 22
HD-80, 37	MH2, 29	R40, 12	RO42B, 26	RT1/04B, 22
HD-90, 37	MH3, 29	R41, 12	RO43/0Q, 26	RT11B, 22
HD1/0B, 24	MH4, 29	R892 B, 11	RO44/0Q, 26	RT12B, 22
HD1A, 24	MLDSL, 28	R892 G, 11	RO44B, 26	RT14B, 22
HD2/0B, 24	MSHC1, 30	R892 O, 11	RO46B, 26	RT2/01/0B, 22
HD26165, 14	MSHC2, 30	R892 R, 11	RO48SB, 26	RT2/01B, 22
HD26166, 14	MSKIT, 30	RA1E-150, 35	RO51/0Q, 26	RT2/02/0B, 22
HD26183, 10	NB121200, 11	RASP, 28	RO51Q, 26	RT2/02B, 22
HD26184, 10	NB12600, 11	RB44019, 12	RO52/0Q, 26	RT2/04B, 22
HD26185, 10	NB581200, 11	RB44020, 12	RO52B, 26	RT22B, 22
HD26188, 16				

Index by Part Number

part number, page number

RT24B, 22	UWM32, 27	XO22B, 22
RT2S2SB, 22	UWM45, 27	XO24B, 22
RT3/01/0B, 22	UWM500, 27	XO3/01/0Q, 22
RT3/01B, 22	UWM65, 27	XO3/01Q, 22
RT3/02/0B, 22	UWM90, 27	XO3/02/0Q, 22
RT3/02B, 22	VA1/0B, 24	XO3/02Q, 22
RT3/03/0B, 22	VA1/0V12X30B, 24	XO3/03/0Q, 22
RT3/04B, 22	VA1/0V2X4B, 24	XO4/01/0Q, 22
RT4/01/0B, 22	VA1/0V4X6B, 24	XO4/01Q, 22
RT4/01B, 22	VA1/0V6X10B, 24	XO4/02/0Q, 22
RT4/02/0B, 22	VA1B, 24	XO4/02Q, 22
RT4/02B, 22	VA1V12X30B, 24	XO4/03/0Q, 22
RT4/03/0B, 22	VA1V2X4B, 24	XO4/04/0Q, 22
RT4/04/0B, 22	VA1V4X6B, 24	
RT4/04B, 22	VA1V6X10B, 24	
RT44B, 22	VA2/0B, 24	
SA-101-ADF-(Color), 12	VA2/0V12X30B, 24	
SA-101-AEF-(Color), 12	VA2/0V2X4B, 24	
SA-101-BDF-(Color), 12	VA2/0V4X6B, 24	
SA-101-BEF-(Color), 12	VA2/0V6X10B, 24	
SA-102-(Color), 12	VA2B, 24	
SA-106-RD, 12	VA2SB, 24	
SA253UA, 35	VA2SV.5X1B, 24	
SB25G, 32	VA2SV1.5X4B, 24	
SB25G5, 32	VA2SV12X30B, 24	
SB45G, 33	VA2SV4X6B, 24	
SB55G, 34	VA2SV6X10B, 24	
SDSD25, 10	VA2V1.5X4B, 24	
SFP2267503, 14	VA2V12X30B, 24	
SFP2267504, 14	VA2V4X6B, 24	
SFP2267506, 14	VA2V6X10B, 24	
SFP3267504, 14	VA3/0B, 24	
SFP3267506, 14	VA3/0V12X30B, 24	
SG51034, 18	VA3/0V2X4B, 24	
SG51036, 7	VA3/0V4X6B, 24	
SG51040, 18	VA3/0V6X10B, 24	
SG51096, 18	VA3B, 24	
SG51155, 7	VA4/0B, 24	
SG51198, 7	VA4/0V12X30B, 24	
SG51201, 7	VA4/0V2X4B, 24	
SG51202, 7	VA4/0V4X6B, 24	
SG51213, 14	VA4/0V6X10B, 24	
SG51214, 14	VA4B, 24	
SM130005, 13	VA4V1.5X4B, 24	
SM130301N, 13	VA4V12X30B, 24	
SM130302N, 13	VA4V4X6B, 24	
SNYL537DH306, 9	VA4V6X10B, 24	
SNYR537DH306, 9	VD1/0B, 23	
TA25, 32	VD1B, 23	
TA45G, 33	VD2/0B, 23	
TA55G, 34	VD2B, 23	
TB25D, 32	VD2SB, 23	
TBSAFETY, 35	VD3/0B, 23	
TOOLBOX, 30	VD4/0B, 23	
tractelift, 45	VD4B, 23	
TRCHD, 28	WEEKENDER, 19	
Tuf-Tug, 45	WRPSLV, 28	
UHF25G, 32	WT2LEDG, 38	
ULTRAFILL, 31	XO1/01/0Q, 22	
ULTRAMH1KIT, 30	XO1/01Q, 22	
ULTRAMH2KIT, 30	XO1/02Q, 22	
UMBCLAMP, 30	XO1/04Q, 22	
UMHDKIT, 30	XO11B, 22	
UWM115, 27	XO12B, 22	
UWM15, 27	XO14B, 22	
UWM150, 27	XO2/01/0Q, 22	
UWM200, 27	XO2/01Q, 22	
UWM25, 27	XO2/02/0Q, 22	
UWM250, 27	XO2/02Q, 22	





4180 E. Sand Ridge Road • Morris, IL 60450
(800) 435-1636 tel • (800) 767-7605 fax
sales@primuselectronics.com
www.primuselectronics.com
Form# 1014W (510) 05/09